

Rukson

SURGICAL INSTRUMENTS
QUALITY YOU DESIRE



SURGICAL INSTRUMENTS CATALOGUE

ABOUT US

We are manufacturer and exporter of surgical instruments, dental instruments, hollowware, manicure and pedicure. We are manufacturing instruments in a high quality controlled under the supervision of highly qualified engineers / professional to satisfy our customers.

The quality management system has been properly implemented and is successfully working at all production stages. We carry out all the necessary tests, inspections and process control activities to ensure that there is no problem with the instruments performance.

The technical specifications are provided for more understanding of the products and to improve the confidence of the customer.



Samples and prices can be obtained on demand. Deliveries of the orders are ensured within time. Although this website doesn't cover all the range of surgical instruments, dental instruments, manicure and pedicure, yet it assures you that we can make every type of instruments. So we will welcome your all inquiries, also for your required instruments which have not been listed in this website.











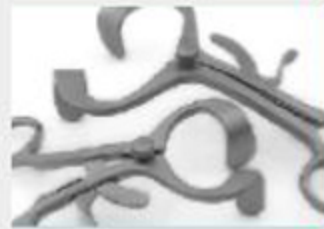

If you have any queries, please don't hesitate to contact us.

Chief Executive



▪ CONTENTS

01		Scalpels Skalpelle Bisturías	Page 01 to 05
02		Diagnostics Diagnostik Diagnóstico	Page 16 to 21
03		Trocars, Vaccination Impfen, Punktion Vacunación, Punción	Page 22 to 29
04		Anaesthesia Narkose Anestesia	Page 30 to 38
05		Scissors Scheren Tijeras	Page 39 to 81
06		Forceps Pinzetten Pinzas	Page 82 to 98
07		Artery Forceps Arterienklemmen Pinzas hemostáticas	Page 99 to 127
08		Cotton Swab Forceps Tupfer-und Kornzangen Pinzas para tapones y curaciones	Page 128 to 131
09		Suture Naht Sutura	Page 132 to 162
10		Probes, Applicators, Spatulas Sonden, Watteträger, Spatel Sondas, Porta-algodones, Espátulas	Page 163 to 168
11		Retractors Wundhaken und -sperrer Separadores	Page 169 to 217
12		Bone Surgery Knochenchirurgie Cirugía ósea	Page 218 to 291
13		Plaster Instruments Plaster Instrumente Instrumentos de yeso	Page 292 to 294

Page 295 to 334	Cardiovascular Surgery Herz- und Gefäßchirurgie Cirugía cardiovascular		14
Page 335 to 365	Neurosurgery Neurochirurgie Neuro Cirugía		15
Page 366 to 396	Ophthalmology Ophthalmologie Oftalmología		16
Page 397 to 414	Otology Otologie Otología		17
Page 415 to 439	Rhinology Rhinologie Rinología		18
Page 440 to 444	Oral Instruments Mund instrumente Cirugía oral		19
Page 445 to 451	Tonsil Mandel Amígdala		20
Page 452 to 456	Tracheotomy Tracheotomie Traqueotomía		21
Page 457	Goitre Kropfchirurgie Bocio		22
Page 458 to 459	Dermatology Dermatologie Dermatología		23
Page 460 to 481	Stomach, Intestine, Rectum Magen, Darm, Mastdarm Estómago, Intestinos, Recto		24
Page 482 to 495	Kidney, Liver, Gall Stone, Urology Niere, Leber, Galle, Urologie Riñón, Hígado, Bilis, Urología		25
Page 496 to 535	Gynecology Gynäkologie Ginecología		26

▪ CONTENTS

27		Obstetrics Geburtshilfe Obstetricia	Page 536 to 542
28		Sterilization Sterilisation Esterilización	Page 543 to 544
29		Asepsis Asepsis Asepsia	Page 545 to 546
30		Hollowware Holloware Hollowware	Page 547 to 552

EN Scalpels

DE Skalpelle

ES Bisturías

Page 1 to 14





Standard
 01-1000-03 # 3



01-1001-03 # 3



01-1002-03 # 3



01-1003-3L # 3L
 01-1003-3XL # 3XL

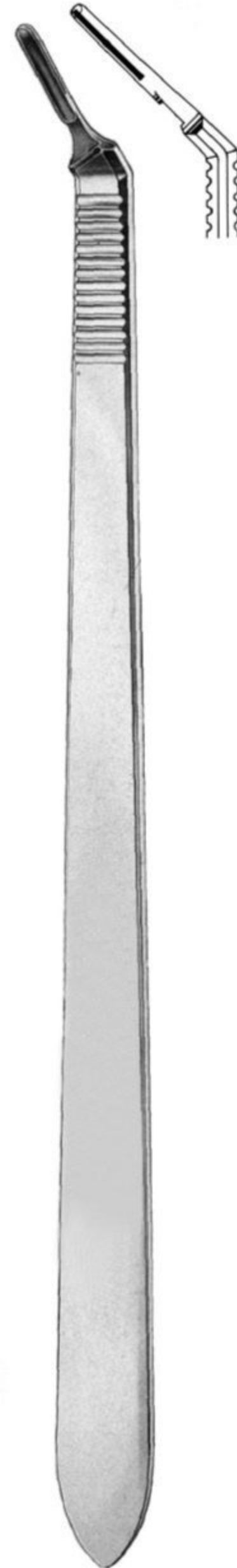

01-1004-3L # 3L
 01-1004-3XL # 3XL
 angled

Scalpel Handles ● EN
 Skalpelli-Griffe ● DE
 Mangos de bisturios ● ES

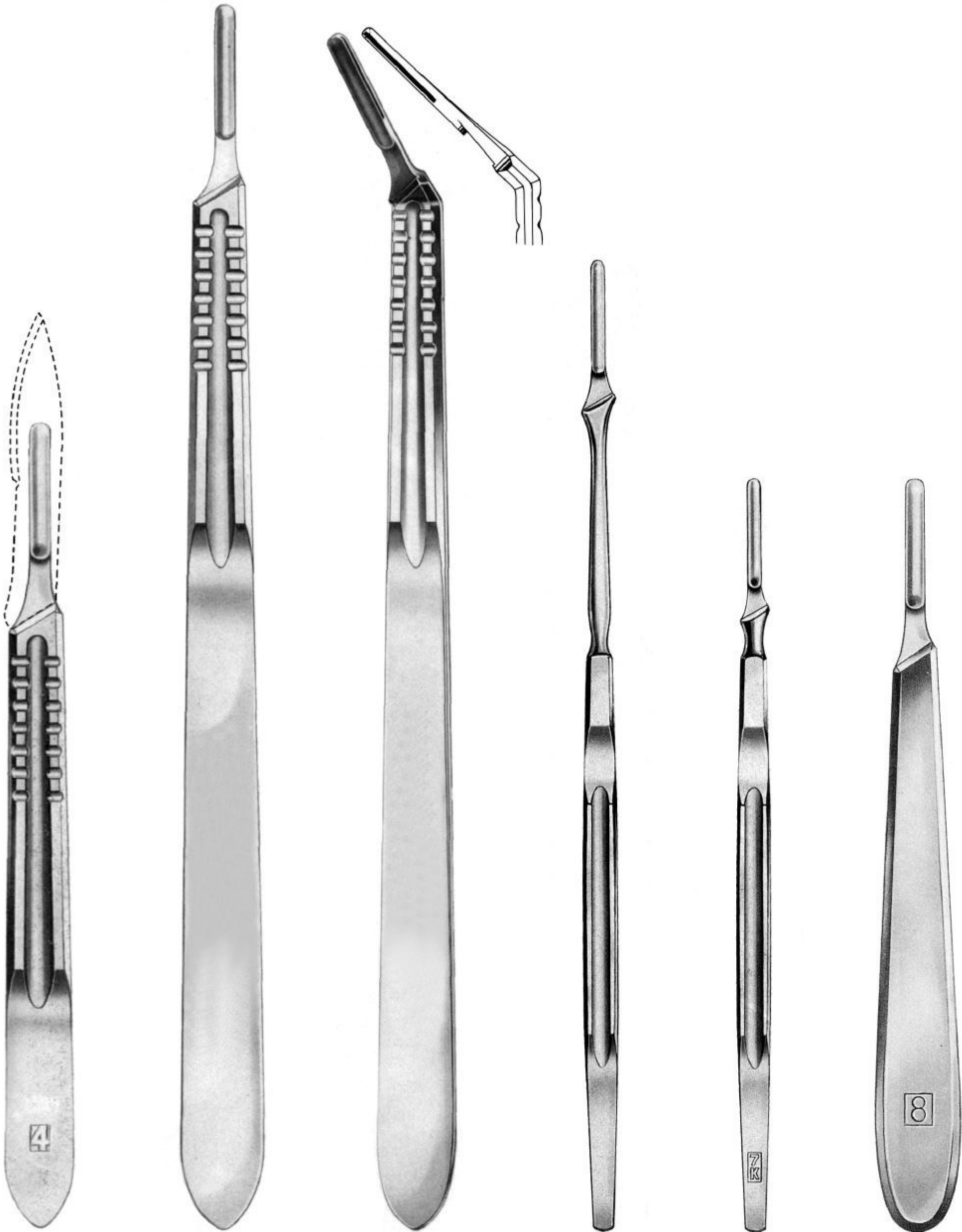

Standard
 01-1005-04 # 4

01-1006-4L # 4L
 01-1006-4XL # 4XL

01-1007-4L # 4L
 01-1007-4XL # 4XL
 angled

01-1008-07 # 7

01-1009-07 # 7K

Collin
 01-1010-08

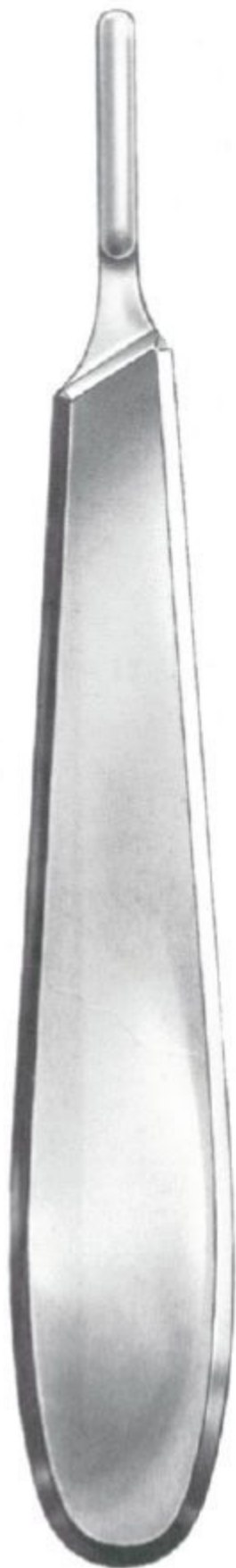

Collin
01-1011-09
Hollow, No. 9



Super
01-1012-10
Hollow, No. 10



01-1013-00
Hollow, round



01-1014-00
Plastics

Dissecting Knives ● EN
 Anatomische Skalpelte ● DE
 Bisturías para disección anatómica ● ES



17cm/6¾"



Fig. 1

01-1015-01



Fig. 2

01-1015-02



Fig. 3

01-1015-03



Fig. 4

01-1015-04



Fig. 5

01-1015-05



Fig. 6

01-1015-06



Fig. 7

01-1015-07



Fig. 8

01-1015-08



Fig. 9

01-1015-09



Fig. 10

01-1015-10

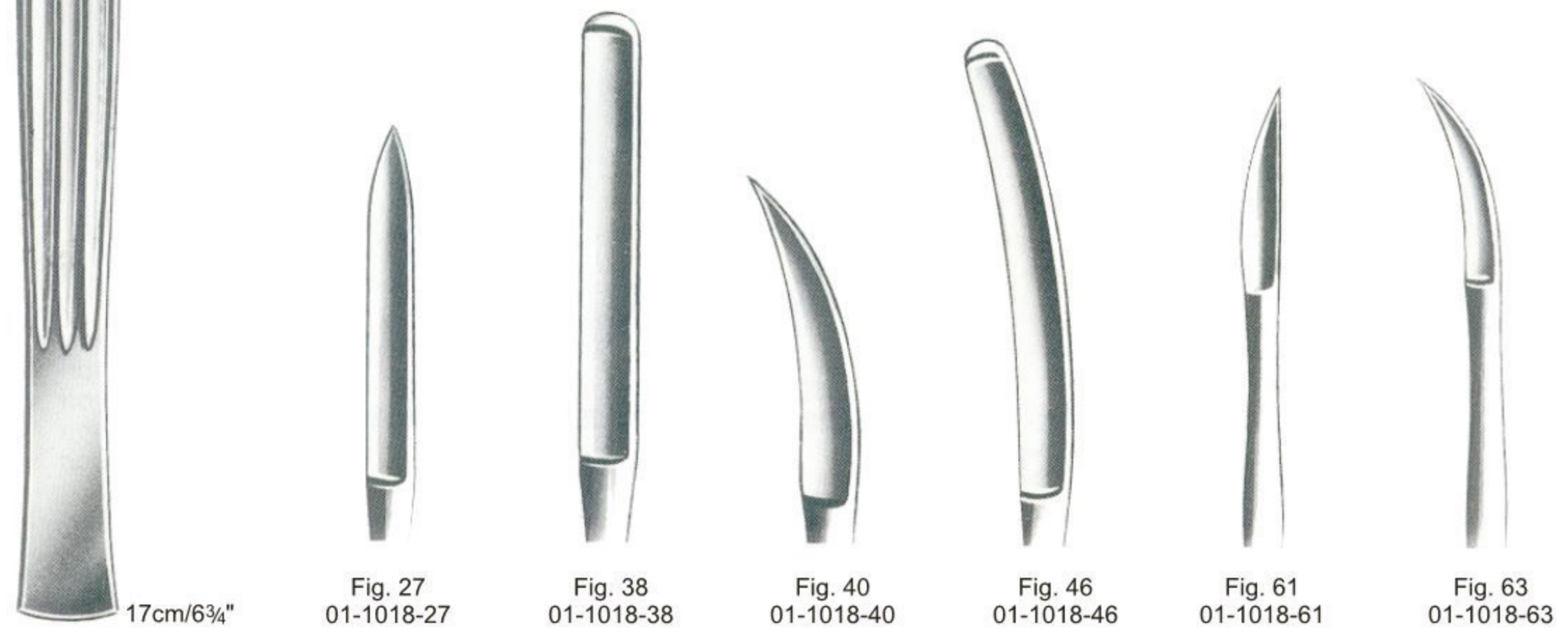
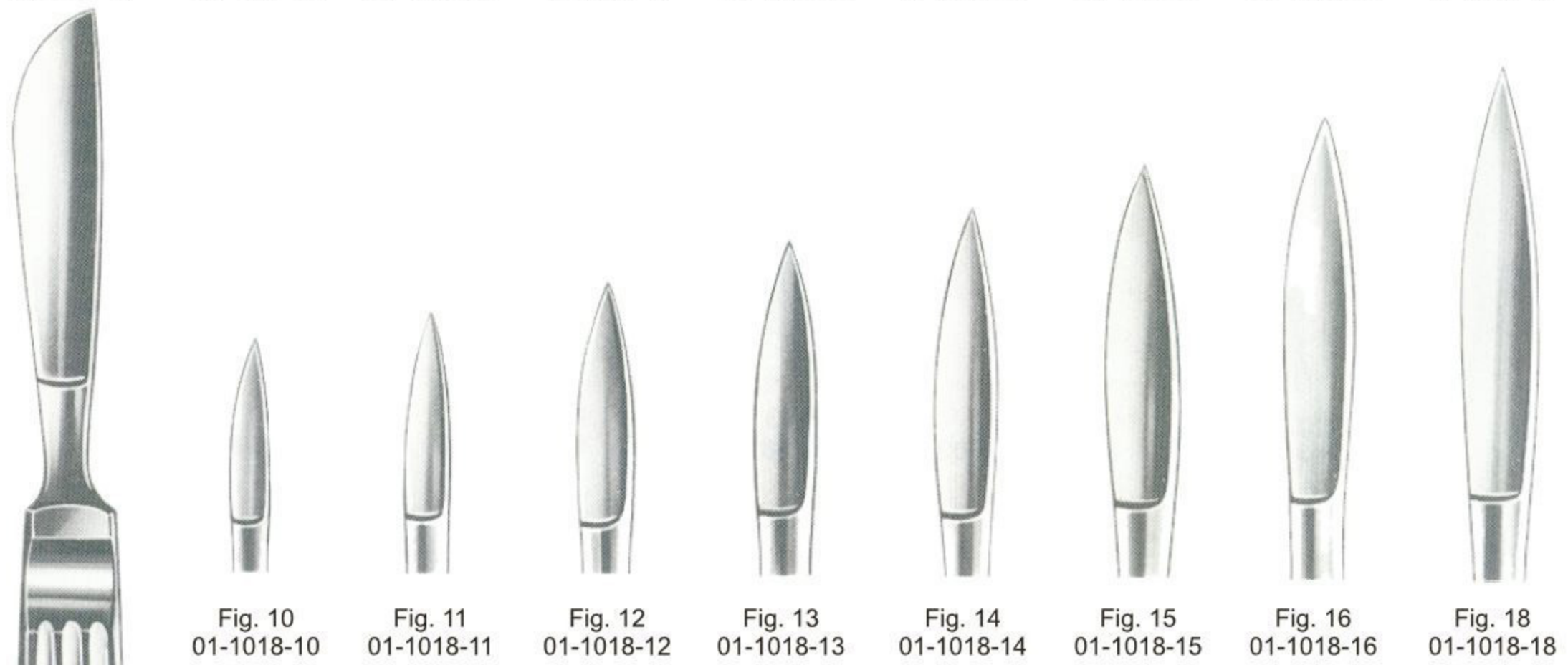

Dissecting Knives ●— EN
 Anatomische Skalpel ●— DE
 Bisturías para disección anatómica ●— ES



Dieffenbach
 17cm/6¾"



Fig. 1
 01-1019-01



Fig. 2
 01-1019-02



Fig. 3
 01-1019-03



Fig. 4
 01-1019-04



Fig. 5
 01-1019-05



Fig. 6
 01-1019-06



Fig. 7
 01-1019-07



Fig. 8
 01-1019-08



Fig. 9
 01-1019-09



Fig. 15
 01-1019-15



Fig. 16
 01-1019-16



Bergmann
 01-1020-01
 14.5cm/5¾"



Fig. 2 01-1020-02
 Fig. 3 01-1020-03
 Fig. 4 01-1020-04



Dieffenbach
 13cm/5¼"

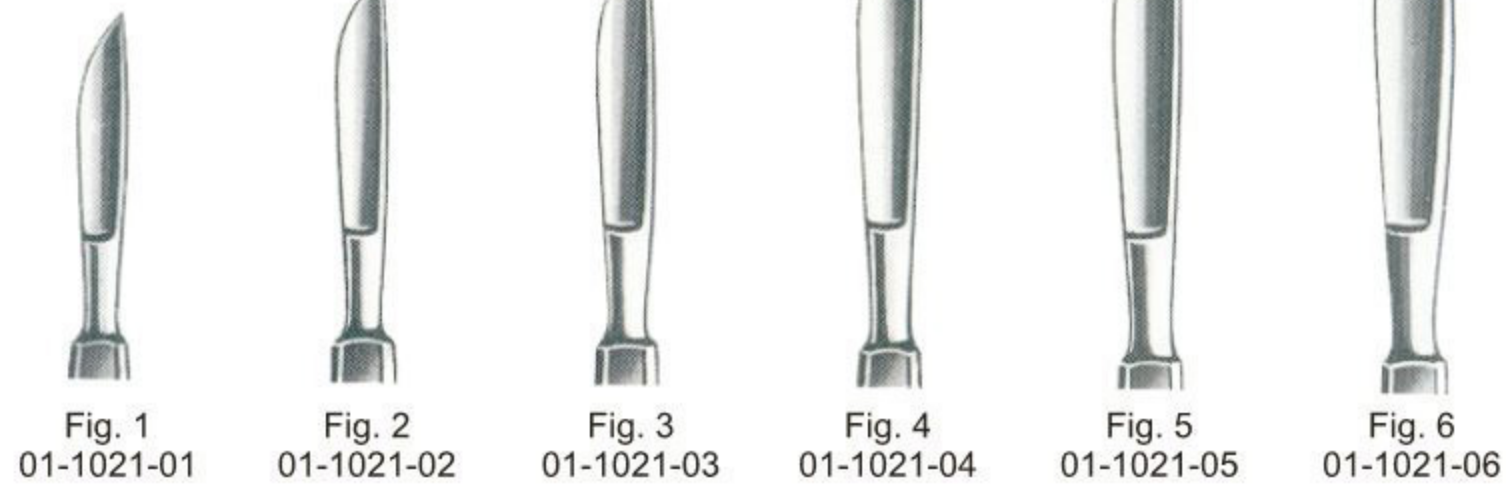

Fig. 1 01-1021-01
 Fig. 2 01-1021-02
 Fig. 3 01-1021-03
 Fig. 4 01-1021-04
 Fig. 5 01-1021-05
 Fig. 6 01-1021-06



Fig. 7 01-1021-07
 Fig. 8 01-1021-08
 Fig. 9 01-1021-09
 Fig. 10 01-1021-10
 Fig. 11 01-1021-11
 Fig. 12 01-1021-12

Dissecting Knives ●— EN
 Anatomische Skalpelte ●— DE
 Bisturías para disección anatómica ●— ES



Simon
20cm/8"



Fig. 1
01-1022-01



Fig. 2
01-1022-02



Fig. 3
01-1022-03



Fig. 4
01-1022-04



Ulrich
22.5 cm/9"



Fig. 1
01-1023-01



Fig. 2
01-1023-02



Fig. 3
01-1023-03



Simon
23.5 cm/9 1/4 "



Fig. 1
01-1024-01



Fig. 2
01-1024-02



Fig. 3
01-1024-03



Fig. 4
01-1024-04



01-1025-01
7.5 cm/3"



01-1026-02
8 cm/3 1/4 "

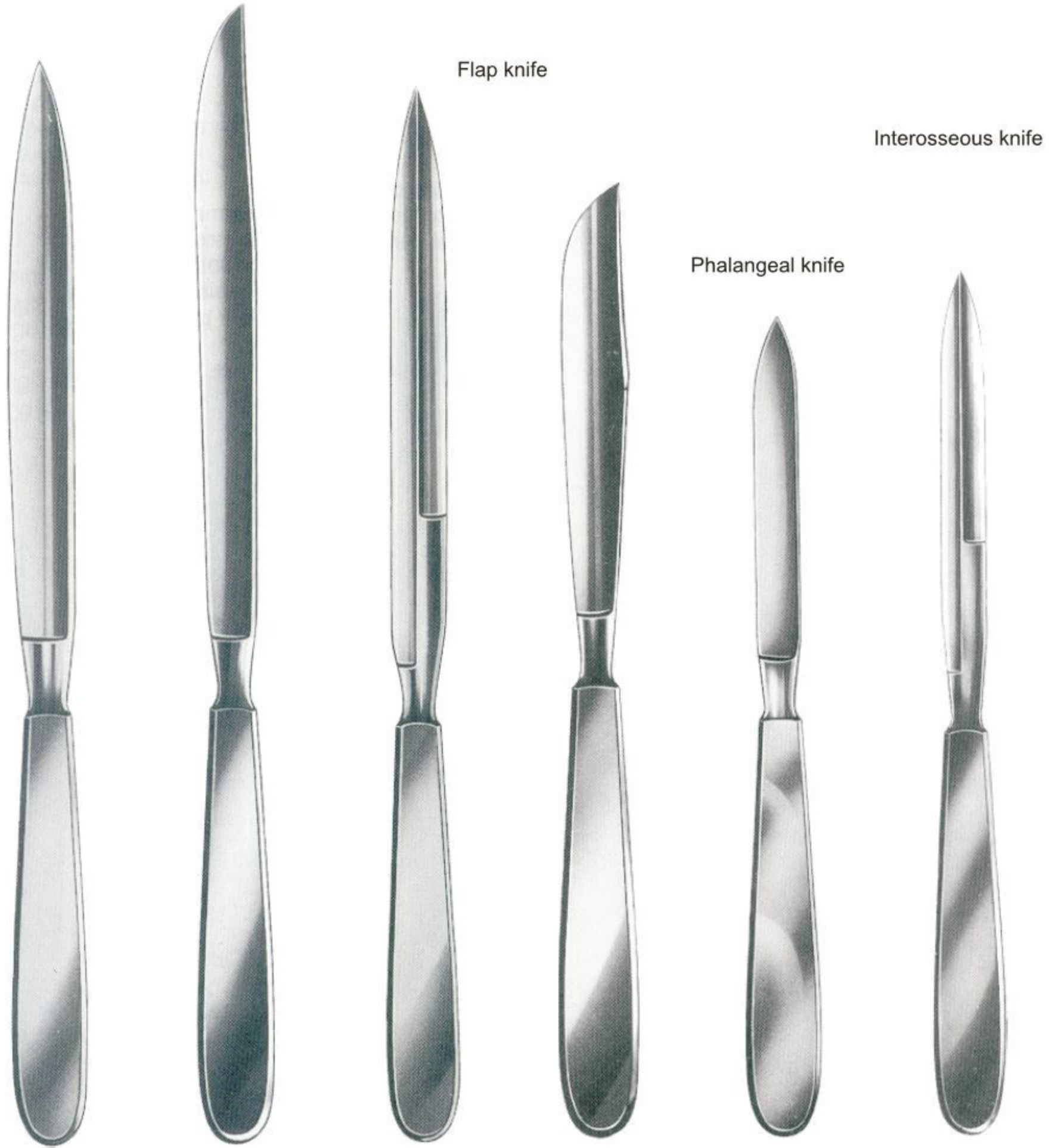

Length of blades		Liston	Catlin	Langenbeck		
cm	in					
9.5	3 3/4				01-1031-09	
11.0	4 1/2					01-1032-11
12.0	4 3/4				01-1030-12	
13.0	5	01-1027-13				
15.0	6					
16.0	6 1/4	01-1027-16		01-1029-16		
17.0	6 3/4		01-1028-17			
19.0	7 1/2	01-1027-19		01-1029-19		
20.0	8		01-1028-20			
22.0	8 3/4	01-1027-22		01-1029-22		



Langenbeck
 01-1033-01
 18 cm/7"

01-1033-02

Virchow

Length of blades

8.5 cm/3 1/2"			01-1037-08
11.0 cm/4 1/2"		01-1035-11	01-1036-11
14.0 cm/5 1/2"		01-1035-14	
16.0 cm/6 1/4"	01-1034-16		
17.0 cm/6 3/4"		01-1035-17	
20.0 cm/8"	01-1034-20		
24.0 cm/9 1/2"	01-1034-24		

Autopsy knives
 Length of blades
 19.5cm/7 3/4"

Length of blades
 9.5cm/3 3/4"

Cartilage knives

Wooden handle

Metal handle

Virchow
 01-1038-09

01-1039-19

01-1040-01

01-1041-01

Dissecting Knives ● EN
 Anatomische Skalpelle ● DE
 Bisturías para disección anatómica ● ES



Troutman-Chris
 01-1042-09
 9cm/3 1/2"



Troutman-Chris
 01-1043-09
 9cm/3 1/2"



01-1044-11
 11cm/4 1/2"



Castroviejo
 01-1045-13
 13cm/5 1/4"



01-1046-18
 18cm/7"



Skull Breaker

01-1047-14
 14 cm/5½"

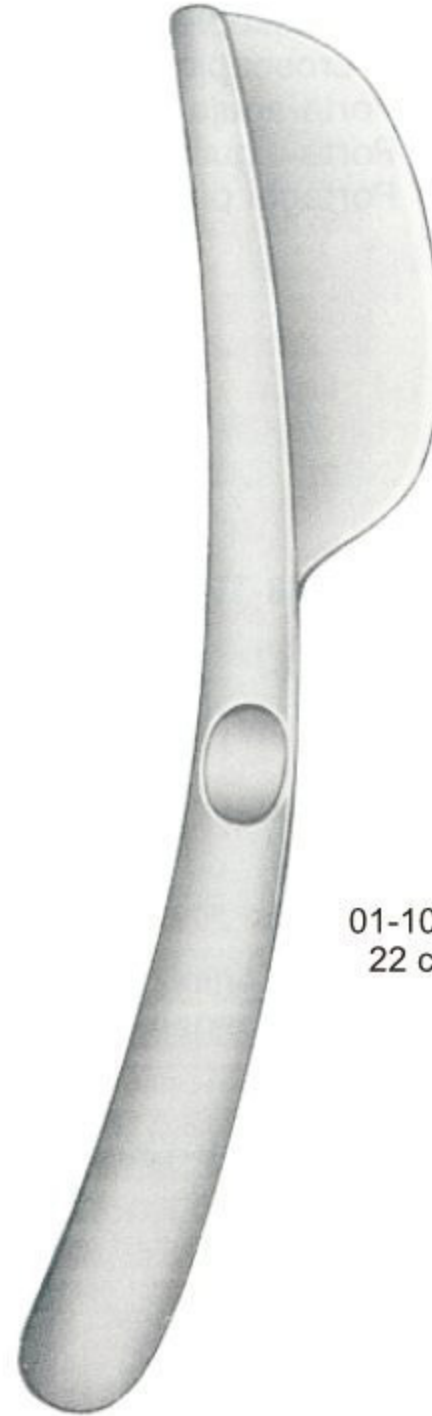

Rachiotome

01-1048-22
 22 cm/8¾"



23 mm

Osteotome

01-1049-13
 13 cm/5"

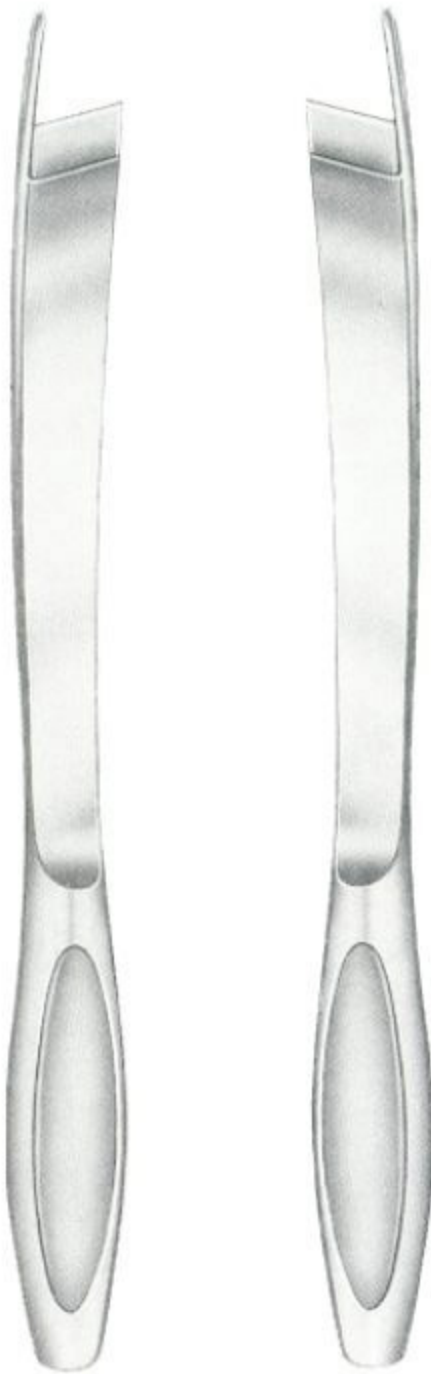

Brunetti 01-1050-28
Brunetti 01-1051-28
 28.5 cm/11¼"

Muscle hooks



01-1052-06
 6.5 cm/2½"



01-1053-07
 7 cm/2¾"



01-1054-01

Microscopic needles



01-1055-13
13 cm/5"



01-1056-13
13 cm/5"



Microscopic needle holder

Kolle
 01-1057-24
 24 cm/ 9½"



Loop for needle holder

01-1058-06
6 cm/2 ¼"

Post mortem needles



01-1059-01

01-1060-02

01-1061-03

01-1062-04

01-1063-05

01-1064-06

EN Diagnostics

DE Diagnostik

ES Diagnóstico

Page 15 to 20





Taylor
 02-1101-18 18.0cm
 02-1101-20 20.0cm



Dejerine
 02-1102-20 20.0cm



Dejerine
 02-1103-21 21.0cm
 02-1103-35 35.0cm



Neuro-Duoflex
 02-1104-22 22.0cm

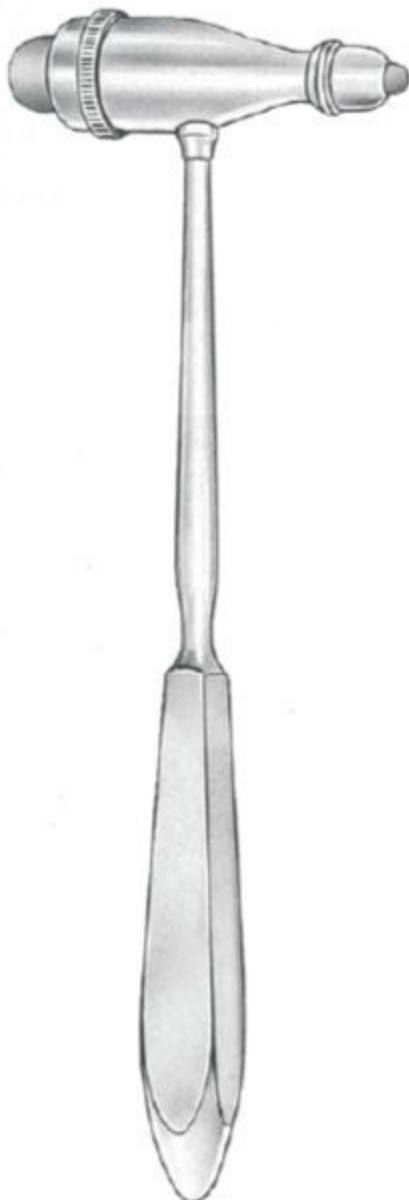

Troemner
 02-1105-24 24.0cm

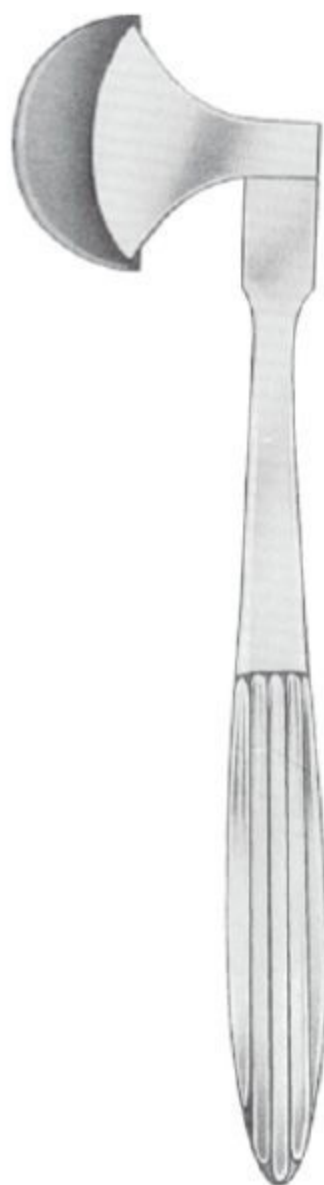

Berliner
 02-1106-20
 20cm/8"



Buck
 02-1107-18 18.0cm



Buck (Telescopic)
 02-1108-18 18.0cm

Percussion Hammers ● EN
 Perkussionshämmer ● DE
 Martillos de percusión ● ES



Traube
 02-1109-16
 16 cm/6 1/4"



Troemner
 02-1110-21
 21cm/8 1/4"



Divers-Duoflex
 02-1111-22
 22 cm/8 3/4"



Babinsky
 02-1112-22 22 cm/8 3/4"
 02-1112-25 25 cm/10"



Rabiner
 02-1113-23
 23 cm/9 1/4"



National Hospital
 02-1114-33
 33 cm/13"



Queen Square
 02-1115-26
 26 cm/10 1/4"



Pinard
 02-1116-18 18.0cm
 (wooden)



Pinard
 02-1117-15 15.0cm
 (plastic)



Pinard
 02-1118-15 15.0cm
 (aluminum)

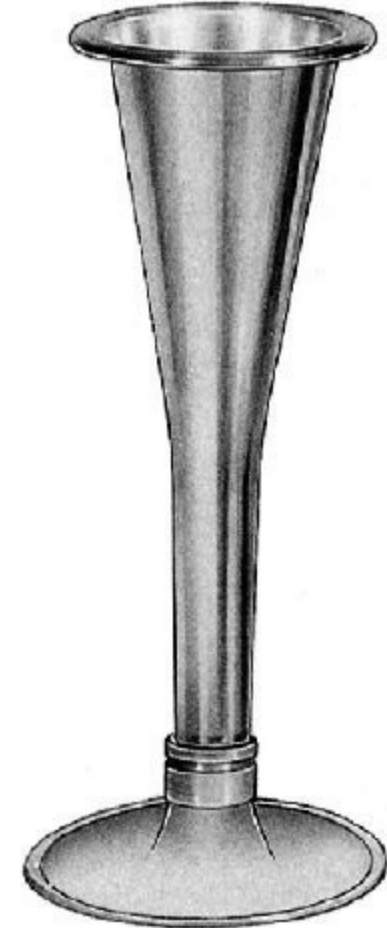

Pinard
 02-1119-15 15.0cm
 (aluminum)



Aly
 02-1120-17
 17cm/6¾"



Wartenberg
 02-1121-19
 19cm/7½"



Weber
 02-1122-09
 9cm/3½"



02-1123-15 15.0cm
 02-1123-30 30.0cm
 02-1123-60 60.0cm

Examination and Measuring Instruments, Stethoscopes ● EN
 Prüf- und Meßinstrumente, Stethoskope ● DE
 Instrumentos para exámenes y medidas, Estetoscopios ● ES

Goniometer



Moltgen
 02-1124-00

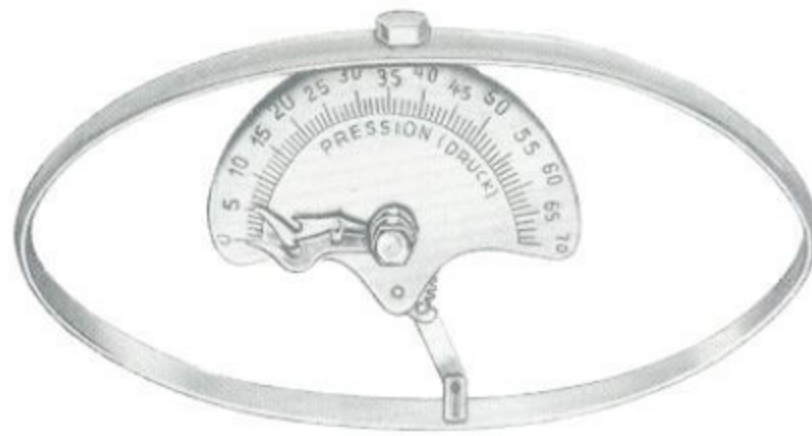

Collin

for children 02-1125-01 for adults 02-1125-02



Townley
 02-1126-10
 10cm/4"

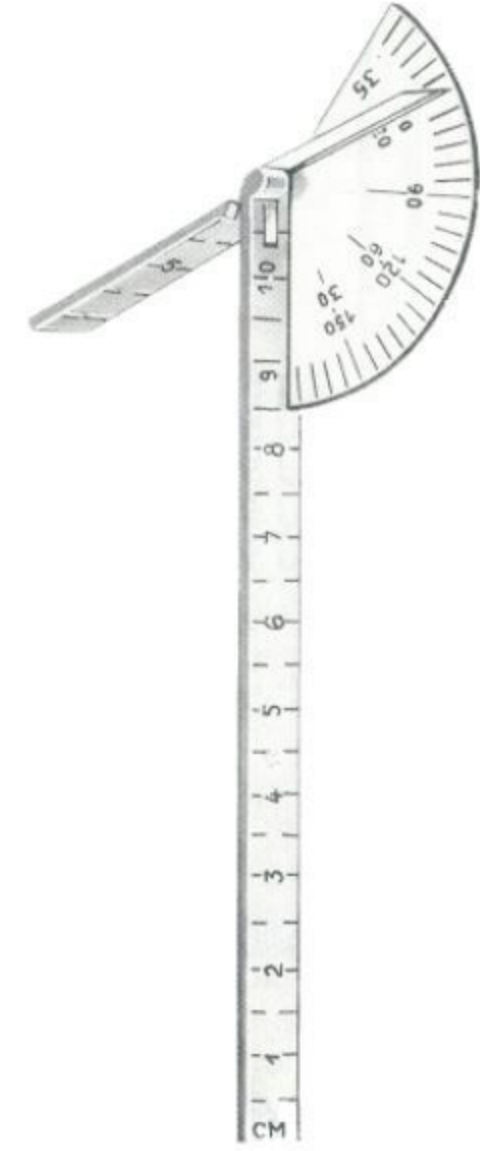

Caroll
 02-1127-14
 14cm/5½"



Chest piece only
 02-1128-01

Ford
 02-1128-00



Chest piece only
 02-1129-01

Dual
 02-1129-00



02-1130-00



02-1131-00

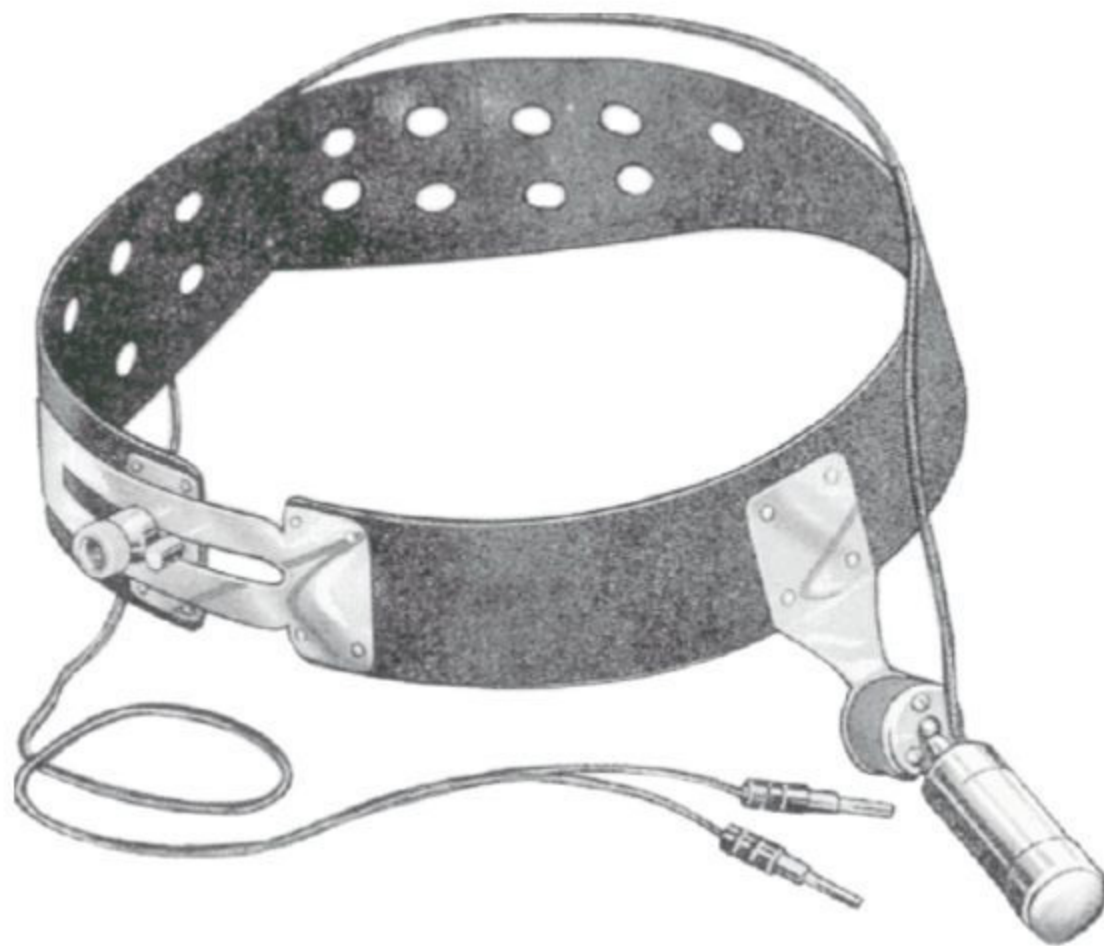

02-1132-00



Jansen
02-1133-00

Diagnostic Sets ● EN
 Diagnostik - Bestecke ● DE
 Juegos para diagnóstico ● ES



02-1134-00
 Otoscope set in Case



02-1135-00
 Otoscope set in Pouch



02-1136-00
 Ophthalmoscope set



02-1137-00
 Ophthalmoscope and Otoscope set



02-1138-00
 Complete ENT set

- EN** Trocars, Vaccination
- DE** Impfen, Punktion
- ES** Vacunación, Punción

Page 21 to 27





Nelson
 Ø mm 21cm/8¼"

7.5	03-1201-07
9.0	03-1201-09
10.5	03-1201-10
12.0	03-1201-12



Ochsner
 Ø mm 14.5cm/5½"

4.0	03-1202-40
4.6	03-1202-46
5.5	03-1202-55
6.5	03-1202-65

Ø5.5 mm



Krause
 03-1203-15
 15cm/6"

Ø2.25 mm



Coakley
 03-1204-16
 16cm/6¼"

Ø1.8 mm



Lichtwitz
 03-1205-19
 19cm/7½"

Ø3 mm



Douglas
 03-1206-11
 11.5 cm/4½"



03-1207-11
 11.5 cm/4½"



Pierce
 Ø mm

3.0	03-1208-03
4.0	03-1208-04
5.0	03-1208-05

∅ 2 mm



Landau
 03-1209-16
 16cm/6¼"

∅ 2 mm



Landau
 03-1210-19
 19cm/7½"

∅ 13.5mm



Pean
 03-1211-16
 16cm/6¼"

∅ 8 mm



Buelau
 03-1212-24
 24cm/9½"

Brain Suction Tubes



∅
 2.0 mm 03-1213-20
 2.5 mm 03-1213-25
 3.0 mm 03-1213-30
 13cm/5"

Frazier



∅
 1.5 mm 03-1214-15
 2.0 mm 03-1214-20
 2.5 mm 03-1214-25
 3.0 mm 03-1214-30
 19.5cm/7¾"

Plester



Adson
 03-1215-02
 21cm/8¼"
 ∅4 mm

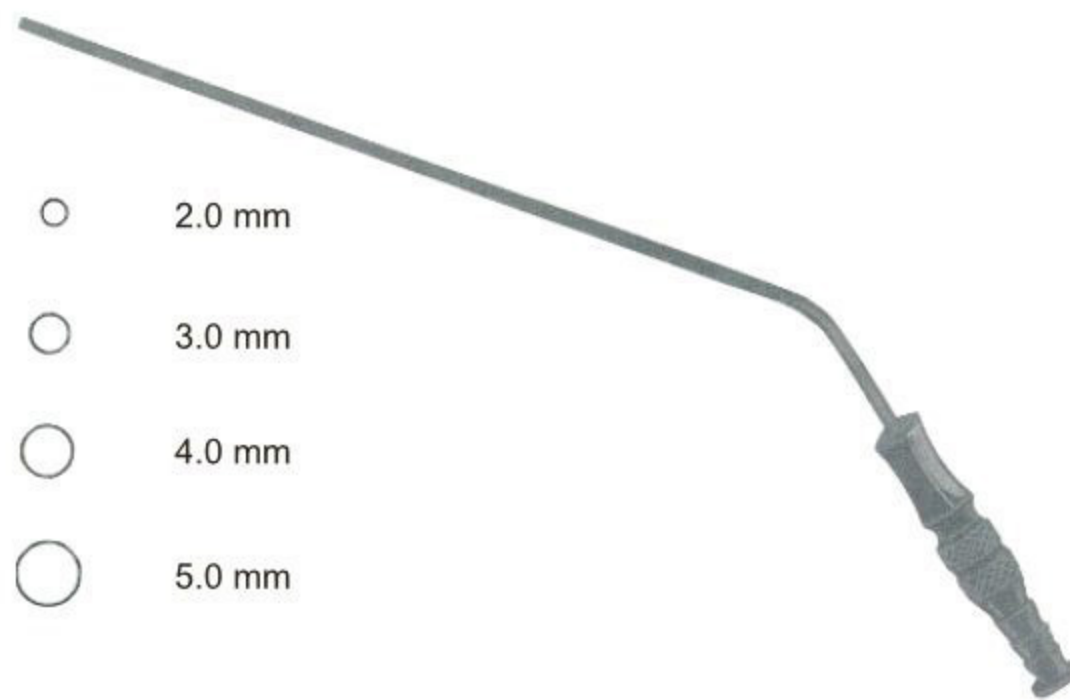

- 2.0 mm
- 3.0 mm
- 4.0 mm
- 5.0 mm

∅ malleable, black
 2 mm 03-1216-02
 3 mm 03-1216-03
 4 mm 03-1216-04
 5 mm 03-1216-05
 19.5cm/7¾"

Suction Tubes ● EN
 Saugrohre ● DE
 Tubos de aspiración ● ES

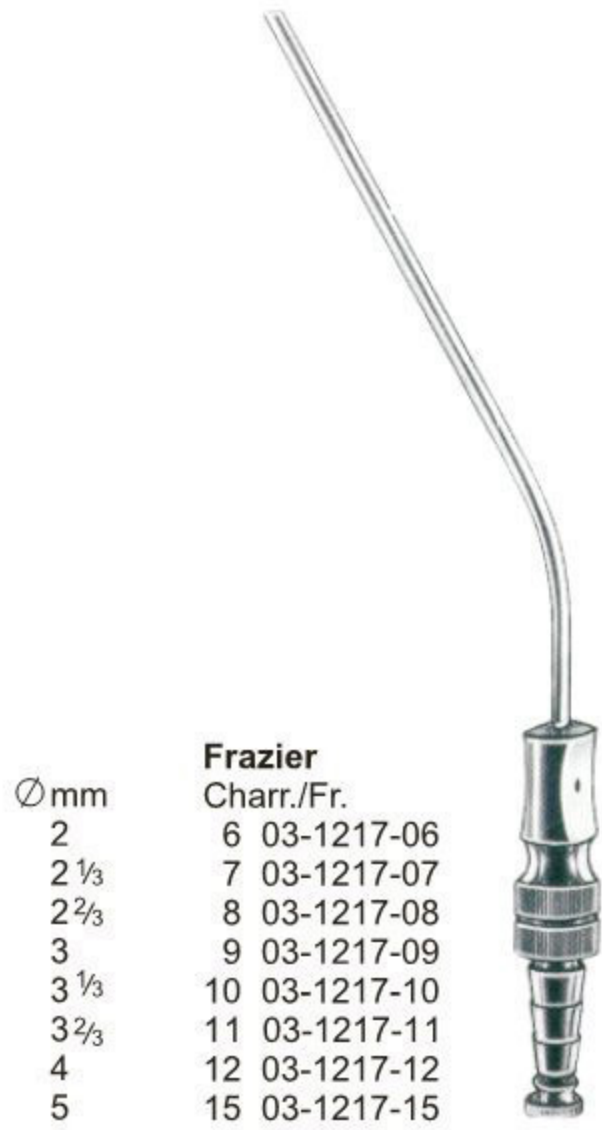

Frazier	
Ømm	Charr./Fr.
2	6 03-1217-06
2 1/3	7 03-1217-07
2 2/3	8 03-1217-08
3	9 03-1217-09
3 1/3	10 03-1217-10
3 2/3	11 03-1217-11
4	12 03-1217-12
5	15 03-1217-15



Ferguson	
Ømm	Charr./Fr.
2	6 03-1218-06
2 1/3	7 03-1218-07
2 2/3	8 03-1218-08
3	9 03-1218-09
3 1/3	10 03-1218-10
3 2/3	11 03-1218-11
4	12 03-1218-12

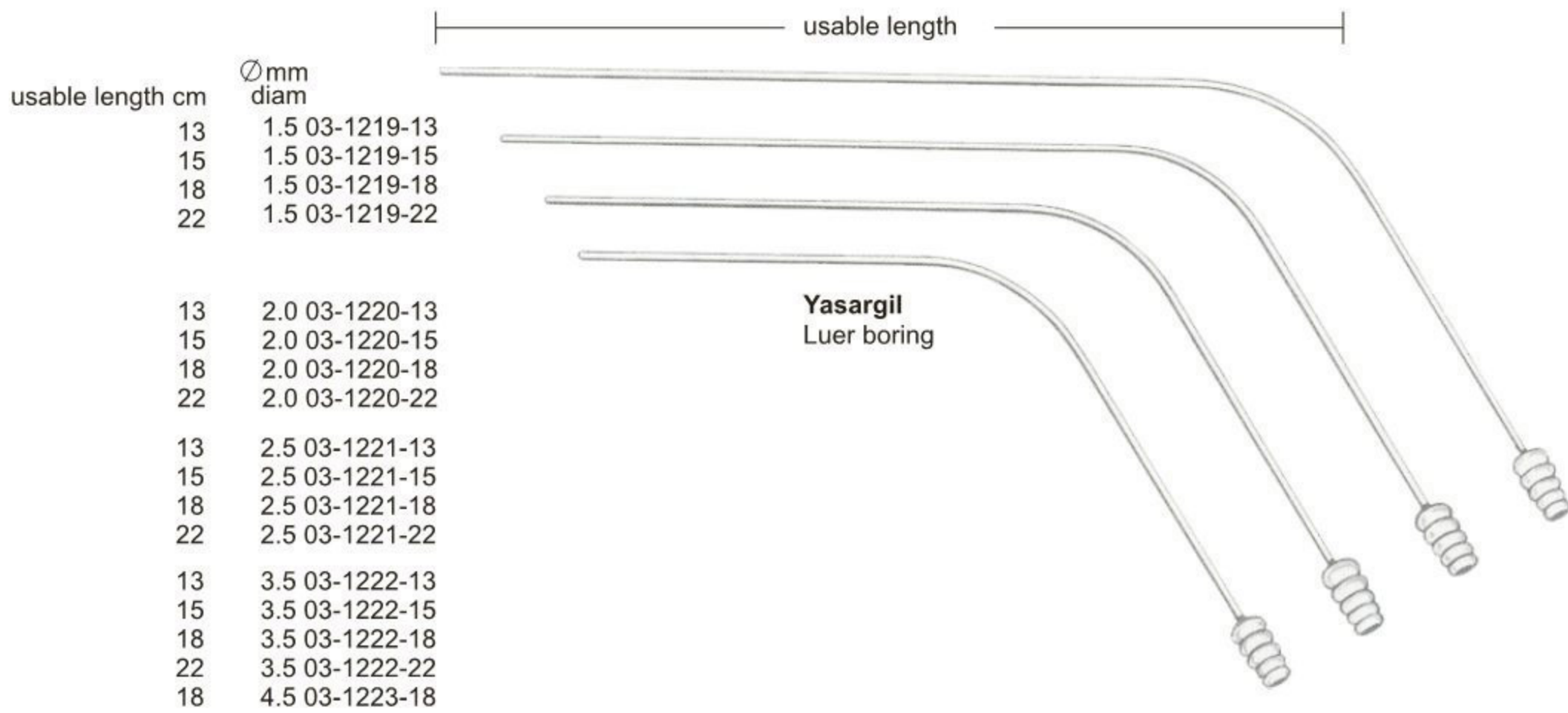

usable length cm	Ømm diam
13	1.5 03-1219-13
15	1.5 03-1219-15
18	1.5 03-1219-18
22	1.5 03-1219-22
13	2.0 03-1220-13
15	2.0 03-1220-15
18	2.0 03-1220-18
22	2.0 03-1220-22
13	2.5 03-1221-13
15	2.5 03-1221-15
18	2.5 03-1221-18
22	2.5 03-1221-22
13	3.5 03-1222-13
15	3.5 03-1222-15
18	3.5 03-1222-18
22	3.5 03-1222-22
18	4.5 03-1223-18

- 1.7 03-1224-17
- 2.5 03-1224-25
- 3.5 03-1224-35

malleable

Yasargil



Yankauer
 03-1225-27
 27cm/10½"



Yankauer
 03-1226-27
 27cm/10½"

with stopcock



Yankauer
 03-1227-01



Fig. 0
 03-1227-10



Fig. 1
 03-1227-11



Fig. 2
 03-1227-12



Fig. 3
 03-1227-13

03-1227-50 SET



∅ 6 mm
 round

Nuboer
 03-1228-01
 21cm/8¼"



6 mm
 ovale

Nuboer
 03-1229-02
 21cm/8¼"

∅ 6 mm



Andrew-Pynchon
 03-1230-23
 23 cm/9"

Suction Tubes ● EN
 Saugrohre ● DE
 Tubos de aspiración ● ES

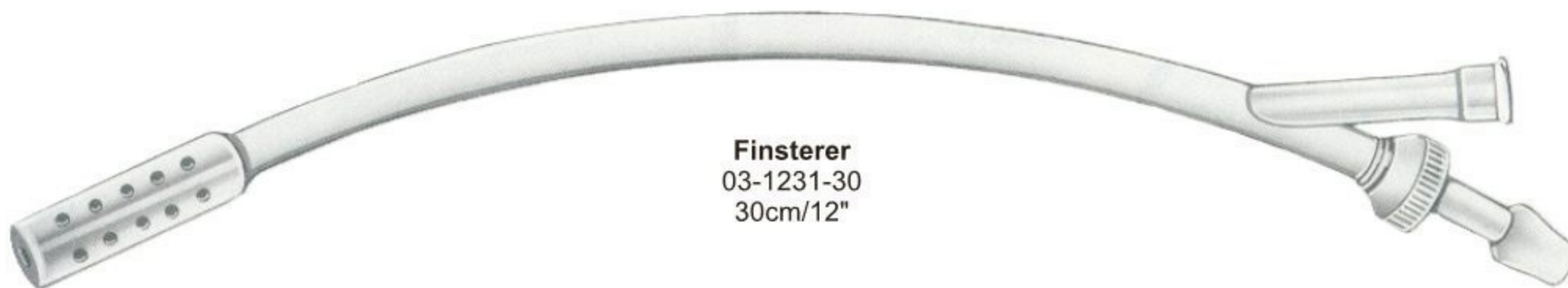

Finsterer
 03-1231-30
 30cm/12"

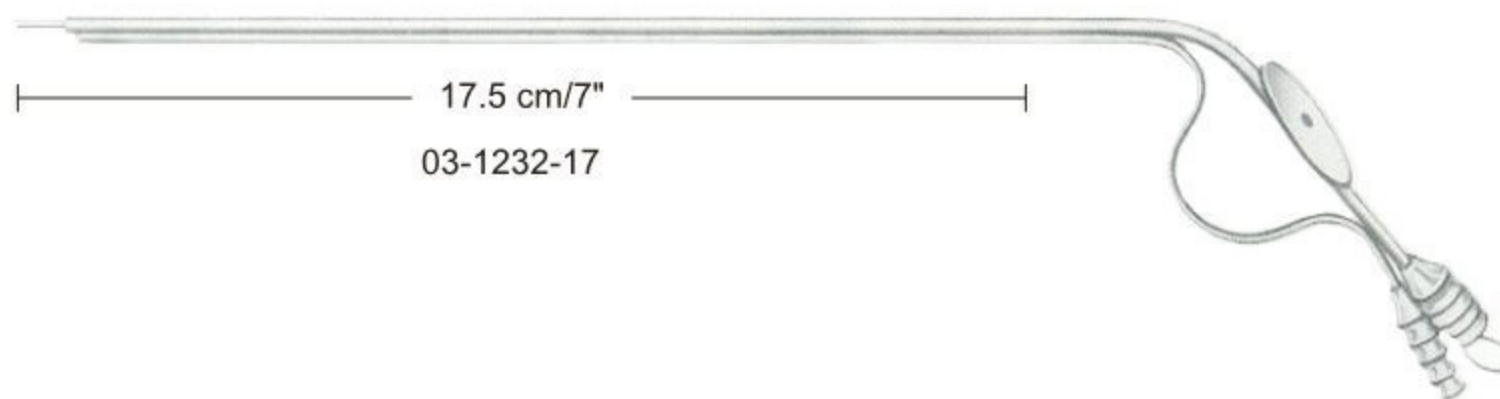

17.5 cm/7"
 03-1232-17

Ø 6 mm



Baby-Poole
 03-1233-20
 20cm/8"

Ø 10 mm



Poole
 03-1234-22
 22cm/8¾"

Ø 8 mm



Poole
 03-1235-22
 22cm/8¾"

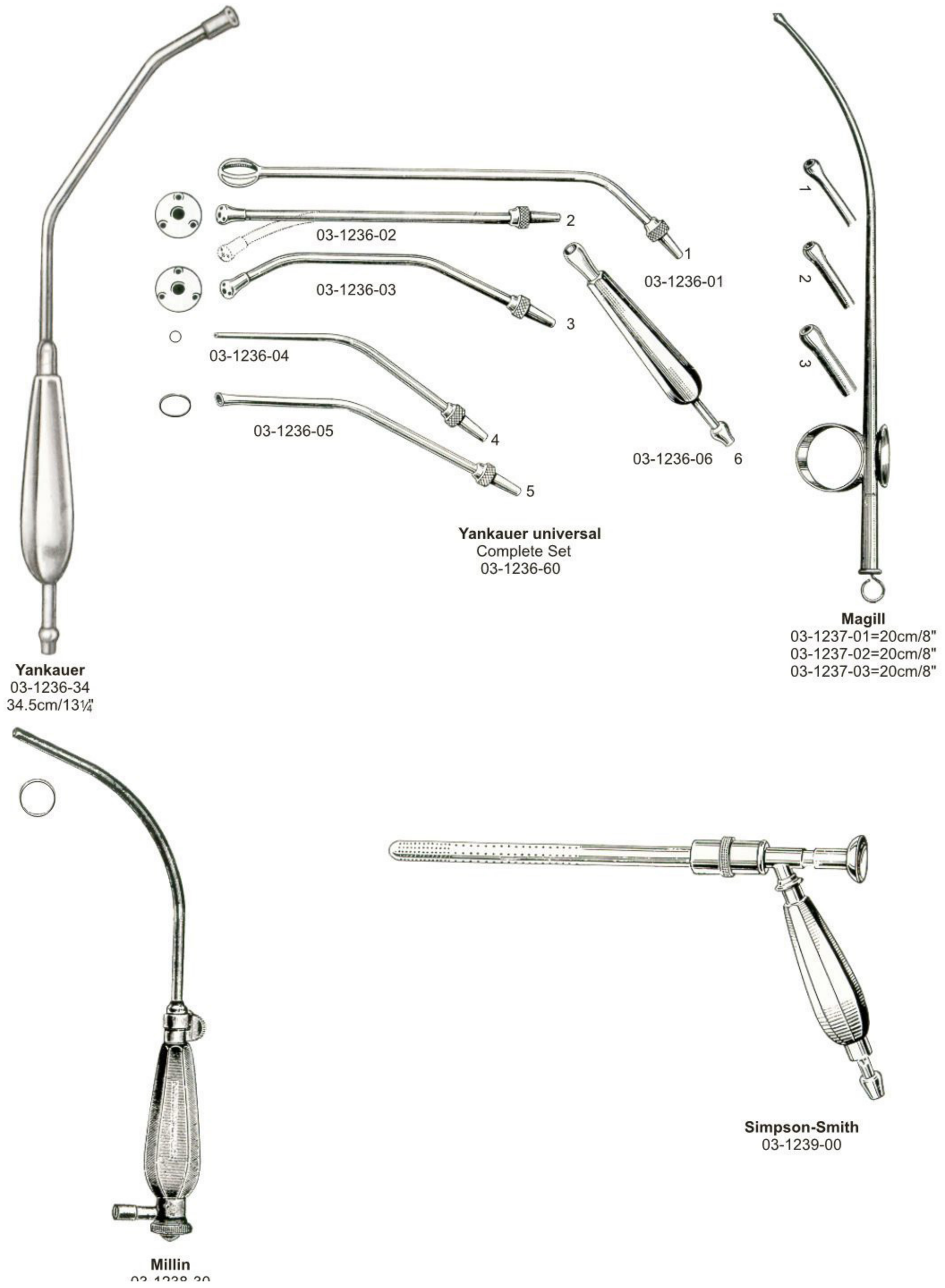

EN Anaesthesia

DE Narkose

ES Anestesia

Page 28 to 36





Miller
 04-1301-30
 04-1301-40

04-1301-30
 Laryngoscope Set
 Consisting of:
 04-1301-00 Battery Handle (without batteries)
 04-1301-11 McIntosh blade, Fig 1
 04-1301-12 ditto, Fig 2
 04-1301-13 ditto, Fig 3

04-1301-40
 Laryngoscope Set
 Consisting of:
 04-1301-00 Battery Handle (without batteries)
 04-1301-11 McIntosh blade, Fig 1
 04-1301-12 McIntosh blade, Fig 2
 04-1301-13 McIntosh blade, Fig 3
 04-1301-14 McIntosh blade, Fig 4

McIntosh Laryngoscope Blades
 04-1301-10 Fig 0, Working length 55mm, baby's
 04-1301-11 Fig 1, Working length 75mm, children's
 04-1301-12 Fig 2, Working length 90mm, adolescent's
 04-1301-13 Fig 3, Working length 110mm, women's
 04-1301-14 Fig 4, Working length 135mm, men's



04-1301-10
 Fig. 0
 55 mm



04-1301-11
 Fig. 1

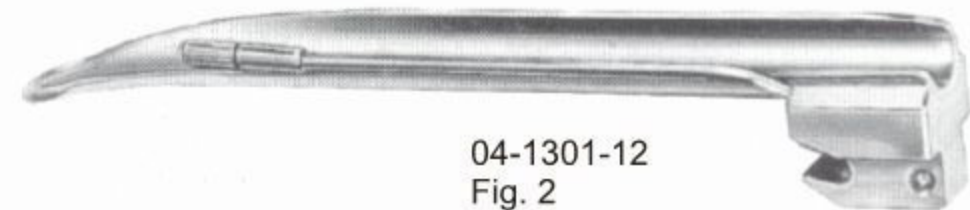

04-1301-12
 Fig. 2



04-1301-13
 Fig. 3



04-1301-14
 Fig. 4

Laryngoscopes ● EN
 Laryngoskope ● DE
 Laringoscopios ● ES



McIntosh
 04-1302-30
 04-1302-40

04-1302-30
 Laryngoscope Set
 Consisting of:
 04-1302-00 Battery Handle (without batteries)
 04-1302-11 McIntosh blade, Fig 1
 04-1302-12 ditto, Fig 2
 04-1302-13 ditto, Fig 3



04-1302-10

04-1302-11

04-1302-40
 Laryngoscope Set
 Consisting of:
 04-1302-00 Battery Handle (without batteries)
 04-1302-11 McIntosh blade, Fig 1
 04-1302-12 McIntosh blade, Fig 2
 04-1302-13 McIntosh blade, Fig 3
 04-1302-14 McIntosh blade, Fig 4



04-1302-12



04-1302-13



04-1302-14

McIntosh Laryngoscope Blades
 04-1302-10 Fig 0, Working length 55mm, baby's
 04-1302-11 Fig 1, Working length 75mm, children's
 04-1302-12 Fig 2, Working length 90mm, adolescent's
 04-1302-13 Fig 3, Working length 110mm, women's
 04-1302-14 Fig 4, Working length 135mm, men's



Foregger
 04-1303-30
 04-1303-40

04-1303-30
 Laryngoscope Set
 Consisting of:
 04-1303-00 Battery Handle (without batteries)
 04-1303-12 Foregger Blade, Fig 2
 04-1303-13 ditto, Fig 3
 04-1303-14 ditto, Fig 4

04-1303-40
 Laryngoscope Set
 Consisting of:
 04-1303-00 Battery Handle (Without batteries)
 04-1303-11 Foregger Blade, Fig 1
 04-1303-12 Foregger Blade, Fig 2
 04-1303-13 Foregger Blade, Fig 3
 04-1303-14 Foregger Blade, Fig 4



04-1303-11



04-1303-12



04-1303-13



04-1303-14

Foregger Laryngoscope Blade,
 04-1303-11 Fig 1, working length 70mm, children's
 04-1303-12 Fig 2, working length 90mm, adolescent's
 04-1303-13 Fig 3, working length 110mm, women's
 04-1303-14 Fig 4, working length 135mm, men's

Laryngoscopes ●— EN
 Laryngoskope ●— DE
 Laringoscopios ●— ES



04-1304-30
 Laryngoscope Set
 Consisting of:
 04-1304-00 Battery Handle (without batteries)
 04-1304-12 Guedel-Negus Blade, Fig 2
 04-1304-13 ditto, Fig 3
 04-1304-14 ditto, Fig 4

Guedel-Negus
 04-1304-30
 04-1304-40

04-1304-40
 Laryngoscope Set
 Consisting of:
 04-1304-00 Battery Handle (without batteries)
 04-1304-11 Guedel-Negus Blade, Fig 1
 04-1304-12 Guedel-Negus Blade, Fig 2
 04-1304-13 Guedel-Negus Blade, Fig 3
 04-1304-14 Guedel-Negus Blade, Fig 4



04-1304-11



04-1304-12



04-1304-13



04-1304-14

Guedel Laryngoscope Blades
 04-1304-11 Fig 1, working length 70mm, children's
 04-1304-12 Fig 2, working length 90mm, adolescent's
 04-1304-13 Fig 3, working length 110mm, women's
 04-1304-14 Fig 4, working length 135mm, men's

COLD LIGHT LARYNGOSCOPES



04-1305-00
 handle with lamp

McINTOSH
 with fiberoptic



04-1305-50
 set with 5 blades

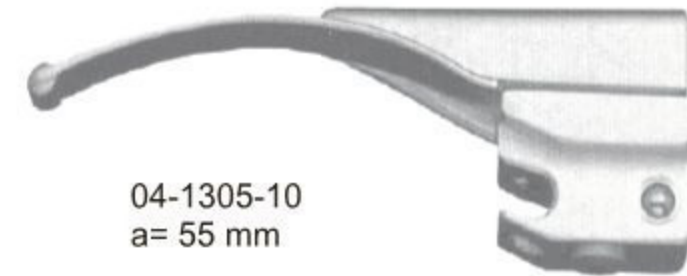
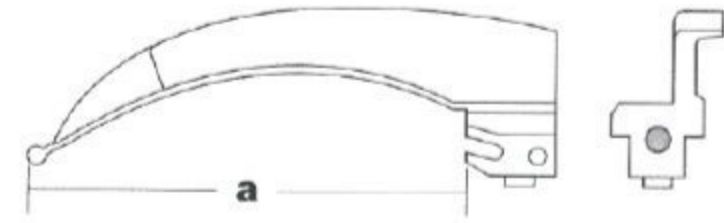

04-1305-10
 a= 55 mm

Fig. 0



04-1305-11
 a= 70 mm

Fig. 1

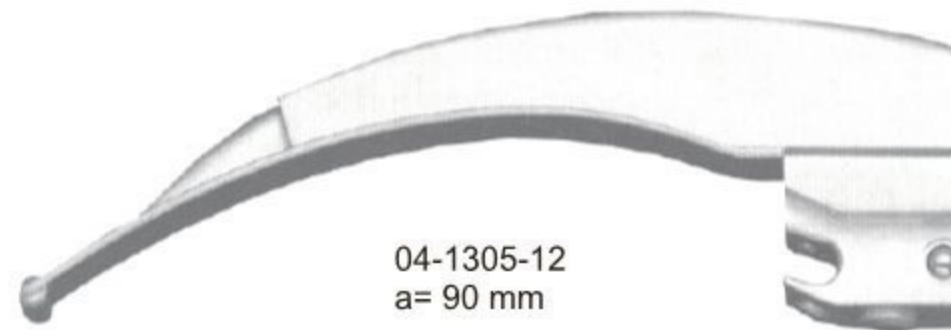

04-1305-12
 a= 90 mm

Fig. 2

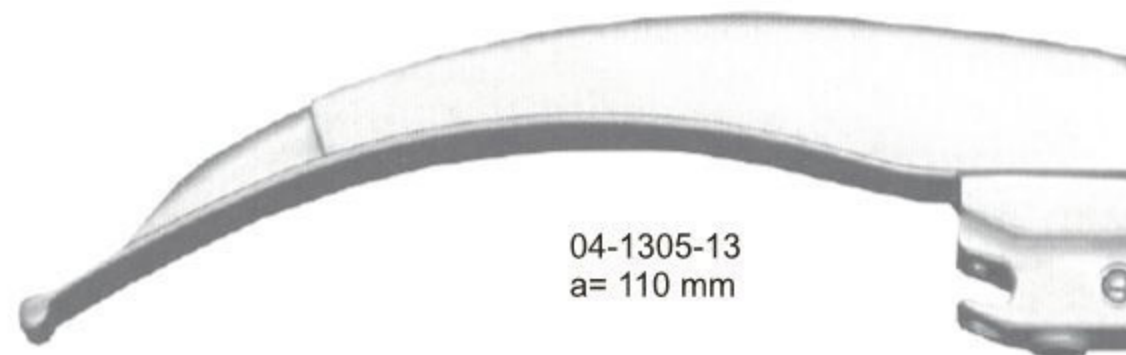

04-1305-13
 a= 110 mm

Fig. 3

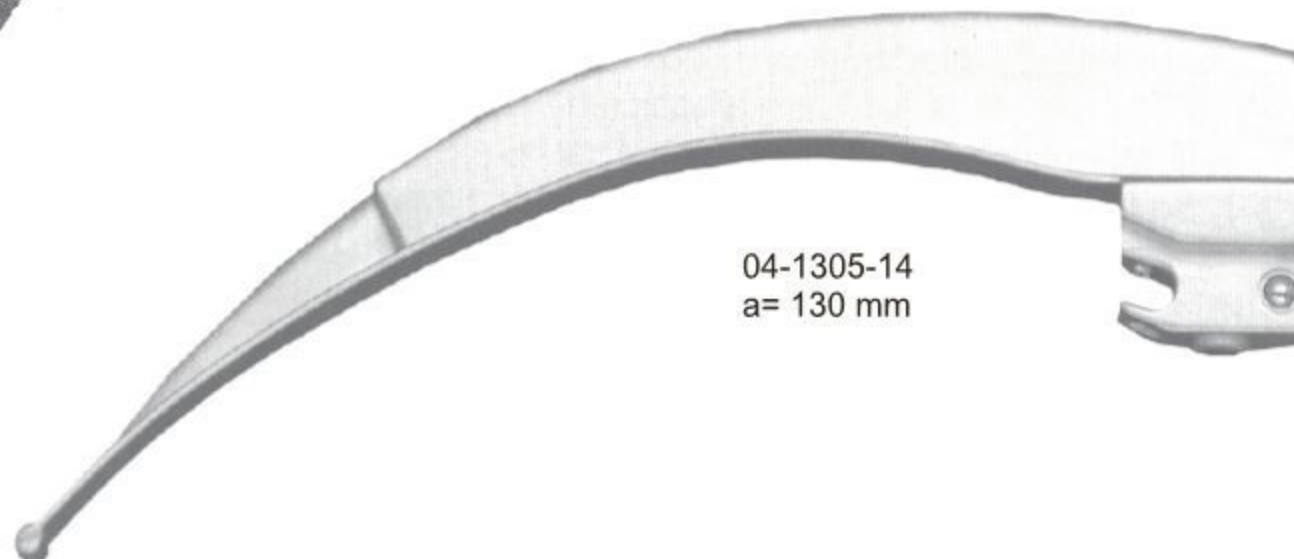

04-1305-14
 a= 130 mm

Fig. 4

COLD LIGHT LARYNGOSCOPES



04-1306-50
 set with 5 blades



04-1306-00
 handle with lamp



04-1306-10
 a= 55 mm

Fig. 0



04-1306-11
 a= 70 mm

Fig. 1



04-1306-12
 a= 90 mm

Fig.2



04-1306-13
 a= 110 mm

Fig. 3



04-1306-14
 a= 130 mm

Fig.4



Working length 55 mm
 04-1307-10

Working length 80 mm
 04-1307-11

Miller-Baby
 04-1307-20

04-1307-20
 Laryngoscope Set, Baby and Infant,
 consisting of :
 04-1307-00 Battery Handle (without battery)
 04-1307-10 Miller-baby blade, Fig 0
 working length 55 mm
 04-1307-11 ditto, Fig 1 working length 80 mm



Negus
 18 mm dia
 04-1308-00



Conventional Handles

	Size	Batteries
04-1309-01	Medium/Standard	2C
04-1309-02	Small/Penlight	2AA
04-1309-03	Stubby	2AA
04-1309-04	Large	2D



Fiber Optic Handles

	Size	Batteries
04-1310-01	Medium/Standard	2C
04-1310-02	Small/Penlight	2AA
04-1310-03	Stubby	2AA
04-1310-04	Large	2D



Schimmelbusch
 04-1311-01 Child
 04-1311-02 Adult



Magill
 04-1312-15 15 cm/6" Infant
 04-1312-20 20 cm/8" Child
 04-1312-25 25 cm/10" Adult



Yankauer
 04-1313-01 Child
 04-1313-02 Adult



Connel
 04-1314-01 Child
 04-1314-02 Adult



04-1315-01



Lumbard-Mayo
 04-1315-02



04-1315-03

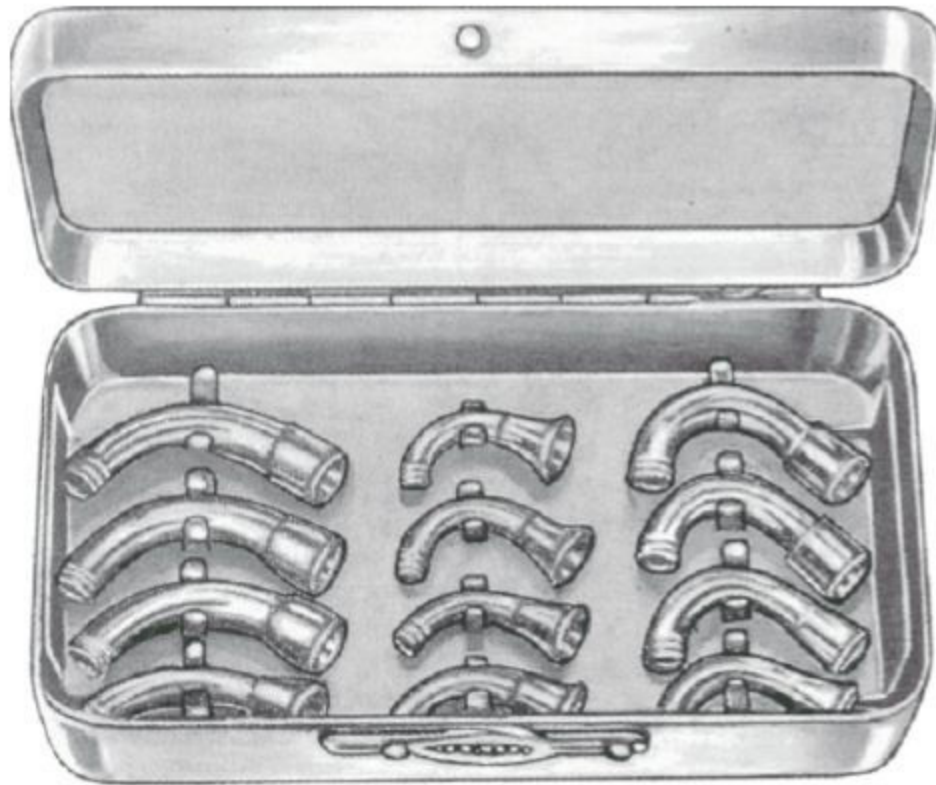

Magill
 Connection Set
 04-1316-00



Magill (Nasal)	mm dia
04-1316-01	5.5
04-1316-02	6.5
04-1316-03	7.5
04-1316-04	8.0
04-1316-05	8.5
04-1316-06	9.5
04-1316-07	10.0
04-1316-08	10.5



Magill (Aural)	mm dia
04-1317-01	5.5
04-1317-02	6.5
04-1317-03	7.5
04-1317-04	8.0
04-1317-05	8.5
04-1317-06	9.5
04-1317-07	10.0
04-1317-08	10.5



Cobb
 04-1318-01 Small
 04-1318-02 Medium
 04-1318-03 Large

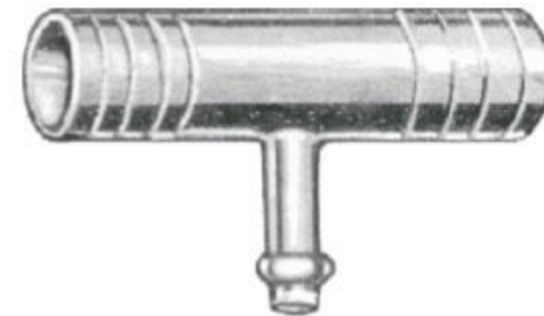

Ayre
 04-1319-01 Small
 04-1319-02 Medium
 04-1319-03 Large



Hamilton Bailey
 04-1320-01 Infant
 04-1320-02 Child
 04-1320-03 Adult



Mitchell
 04-1321-18
 04-1321-20
 38 mm

EN Scissors

DE Scheren

ES Tijeras

Page 37 to 94





Straight

Standard
Fig. 1

10.0	cm/4"	05-1401-10
11.5	cm/4½"	05-1401-11
13.0	cm/5"	05-1401-13
14.5	cm/5¾"	05-1401-14
15.5	cm/6"	05-1401-15
16.0	cm/6¼"	05-1401-16
18.0	cm/7"	05-1401-18
20.0	cm/8"	05-1401-20



Straight

Standard
Fig. 2

05-1402-10
05-1402-11
05-1402-13
05-1402-14
05-1402-15
05-1402-16
05-1402-18
05-1402-20



Straight

Standard
Fig. 3

05-1403-10
05-1403-11
05-1403-13
05-1403-14
05-1403-15
05-1403-16
05-1403-18
05-1403-20



Curved

Standard
Fig. 1

10.0	cm/4"	05-1404-10
11.5	cm/4½"	05-1404-11
13.0	cm/5"	05-1404-13
14.5	cm/5¾"	05-1404-14
15.5	cm/6"	05-1404-15
16.0	cm/6¼"	05-1404-16
18.0	cm/7"	05-1404-18
20.0	cm/8"	05-1404-20



Curved

Standard
Fig. 2

05-1405-10
05-1405-11
05-1405-13
05-1405-14
05-1405-15
05-1405-16
05-1405-18
05-1405-20



Curved

Standard
Fig. 3

05-1406-10
05-1406-11
05-1406-13
05-1406-14
05-1406-15
05-1406-16
05-1406-18
05-1406-20



Grazil



05-1407-13 13.0 cm/5" 05-1408-13
 05-1407-14 14.5 cm/5 3/4" 05-1408-14
 Straight



Grazil



05-1409-13 13.0 cm/5" 05-1410-13
 05-1409-14 14.5 cm/5 3/4" 05-1410-14
 Curved



Straight

05-1411-14



Curved

Deaver

14.5cm/5 3/4"

05-1412-14



Straight

05-1413-15



Curved

Mixer

15.5cm/6"

05-1414-15



Lexer
 Straight
 05-1415-16
 16 cm/6¼"



Lexer
 Curved
 05-1416-16
 16 cm/6¼"



Lexer-Fine
 Straight
 05-1417-16
 16 cm/6¼"



Lexer-Fine
 Curved
 05-1418-16
 16 cm/6¼"

Incision Scissors



05-1419-13 13.0 cm/5¼"
 05-1419-14 14.5 cm/5¾"



05-1420-15
 15.5 cm/6"



Richter
 05-1421-14
 14.5 cm/5¾"



Richter
 05-1422-14
 14.5 cm/5¾"



Mayo
 Straight
 05-1423-14 14.5 cm/5 3/4"
 05-1423-15 15.0 cm/6"
 05-1423-17 17.0 cm/6 3/4"
 05-1423-19 19.0 cm/7 1/2"
 05-1423-23 23.0 cm/9"



Mayo
 Curved
 05-1424-14 14.5 cm/5 3/4"
 05-1424-15 15.0 cm/6"
 05-1424-17 17.0 cm/6 3/4"
 05-1424-19 19.0 cm/7 1/2"
 05-1424-23 23.0 cm/9"



Mayo-Stille
 Straight
 05-1425-15 15 cm/6"
 05-1425-17 17 cm/6 3/4"
 05-1425-19 19 cm/7 1/2"
 05-1425-21 21 cm/8 1/4"



Mayo-Stille
 Curved
 05-1426-15 15 cm/6"
 05-1426-17 17 cm/6 3/4"
 05-1426-19 19 cm/7 1/2"
 05-1426-21 21 cm/8 1/4"



Fergusson
 05-1427-18
 18 cm/7"



New Suture
 05-1428-14
 14.5 cm/5 3/4"



Mayo-Noble
 05-1429-17
 17 cm/6 3/4"



Mayo-Noble
 05-1430-17
 17 cm/6 3/4"

Straight



Fig 1

Metzenbaum
 05-1431-14
 14.5 cm/5¾"



Fig 2

Metzenbaum
 05-1432-14
 14.5 cm/5¾"



Fig 3

Metzenbaum
 05-1433-14
 14.5 cm/5¾"

Straight



Baby-Metzenbaum
 05-1434-11
 11.5 cm/4½"

Curved



Baby-Metzenbaum
 05-1435-11
 11.5 cm/4½"



Metzenbaum-Fine
 05-1436-14
 14.5 cm/5¾"



Metzenbaum-Fine
 05-1437-14
 14.5 cm/5¾"

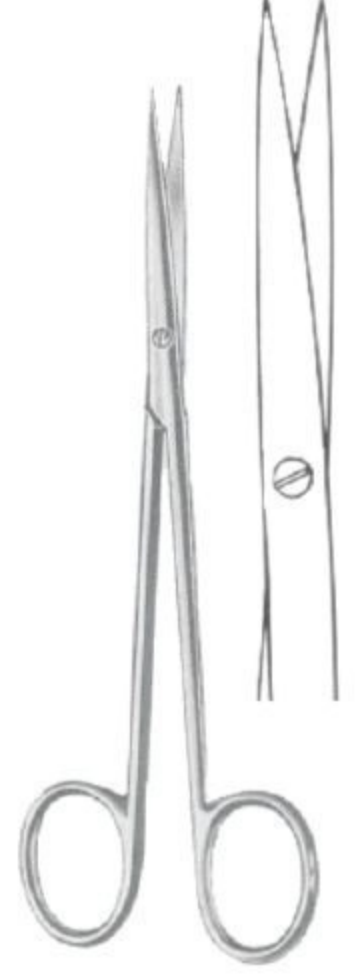

Metzenbaum-Fine
 05-1438-14
 14.5 cm/5¾"



Metzenbaum-Fine
 05-1439-14
 14.5 cm/5¾"

Dissecting Scissors ● EN
 Präparierscheren ● DE
 Tijeras para preparaciones ● ES

Straight



Metzenbaum-Fine

18 cm/7" 05-1440-18
 20 cm/8" 05-1440-20
 23 cm/9" 05-1440-23
 25 cm/10" 05-1440-25
 28 cm/11" 05-1440-28
 30 cm/12" 05-1440-30



Metzenbaum

05-1441-18
 05-1441-20
 05-1441-23
 05-1441-25
 05-1441-28
 05-1441-30



Metzenbaum

05-1442-18
 05-1442-20
 05-1442-23
 05-1442-25
 05-1442-28
 05-1442-30



Metzenbaum

05-1443-18
 05-1443-20
 05-1443-23
 05-1443-25
 05-1443-28
 05-1443-30



Sims

05-1444-20 20 cm/8"
 05-1444-23 23 cm/9"



Straight

05-1445-20 20 cm/8" 05-1446-20
 05-1445-23 23 cm/9" 05-1446-23



Curved

05-1448-20 20 cm/8" 05-1449-20
 05-1448-23 23 cm/9" 05-1449-23



Sims

05-1447-20 20 cm/8"
 05-1447-23 23 cm/9"



Curved

Dubois
 05-1450-27 27 cm/10½"



Dubois
 05-1451-27 27 cm/10½"



Straight

Doyen
 05-1452-16 16 cm/6¼"
 05-1452-18 18 cm/7"



Curved

Doyen
 05-1453-16 16 cm/6¼"
 05-1453-18 18 cm/7"



Kelly
 05-1454-16 16 cm/6¼"
 05-1454-18 18 cm/7"



Kelly
 05-1455-16 16 cm/6¼"
 05-1455-18 18 cm/7"



Fig. 1
05-1456-12



Fig. 2
05-1457-12

Straight



Fig. 3
05-1458-12

12cm/4¾"



Fig. 1
05-1459-12



Fig. 2
05-1460-12

Curved



Fig. 3
05-1461-12

12cm/4¾"

Saw Edge



Wagner
12cm/4¾"

Curved



Fig. 1
05-1462-12



Fig. 2
05-1463-12



Fig. 3
05-1464-12



Fig. 4
05-1465-12



Fig. 1
05-1466-12



Fig. 2
05-1467-12



Fig. 3
05-1468-12



Fig. 4
05-1469-12

Straight

Curved



05-1470-12
11.5cm/4½"



05-1471-12
11.5cm/4½"



Straight

Brophy (Sullivan)

05-1472-14

14.5 cm/5 ¾"

05-1473-14



Curved



Straight

Reynolds

05-1474-15

15 cm/6"

05-1474-18

18 cm/7"



Curved

05-1475-15

05-1475-18

Enucleation Scissors



Jameson
 05-1476-15
 15cm/6"



05-1477-12



05-1478-12



Landolt
 12.5cm/5"

05-1479-12



05-1480-12

Fine Scissors ● EN
 Feine chirurgische Scheren ● DE
 Tijeras finas para cirugía ● ES



9.0 cm/3½"	05-1481-09	05-1482-09	05-1483-09	05-1484-09	Standard	05-1485-09
10.5 cm/4¼"	05-1481-10	05-1482-10	05-1483-10	05-1484-10		05-1485-10
11.5 cm/4½"	05-1481-11	05-1482-11	05-1483-11	05-1484-11		05-1485-11

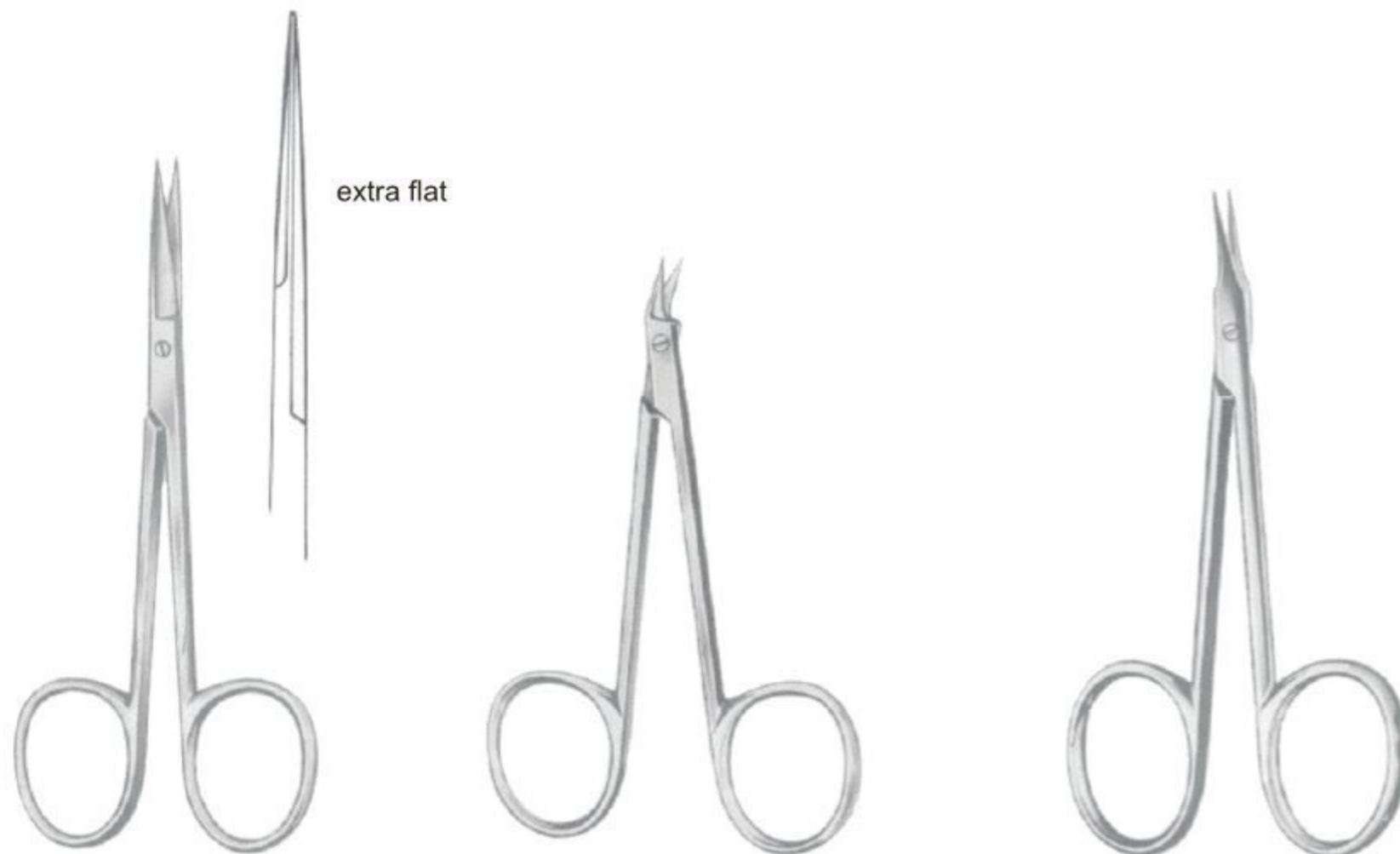

05-1486-10
10cm/4"

05-1487-09
9cm/3½"

Walton
05-1488-10
10cm/4"

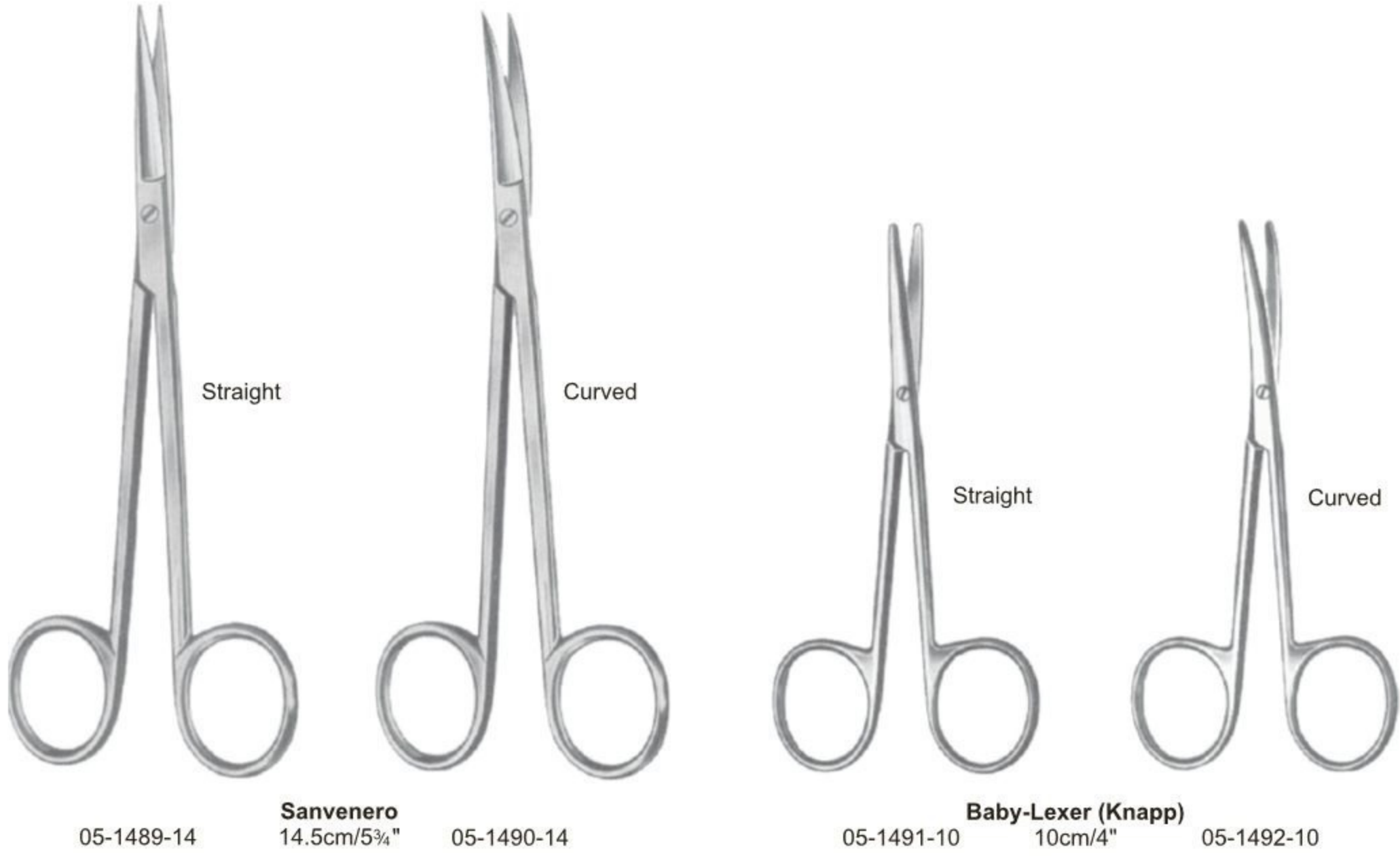

Dissecting, Vascular Scissors ● EN
 Präparierscheren, Gefäßscheren ● DE
 Tijeras para preparacionesa, Tijeras vasculares ● ES



Kilner (Ragnell)
 05-1497-12 12cm/4 3/4"
 05-1497-13 13cm/5"
 05-1497-15 15cm/6"



05-1498-14
 14.5cm/5 3/4"

Coronary Scissors



05-1499-11
 11.5cm/4 1/2"



Potts-Smith
 05-1500-19
 19.5cm/7 3/4"



De Bakey
 05-1501-15
 15.5cm/6"



De Bakey
 05-1502-15
 15.5cm/6"



Favaloro
 05-1503-15
 15cm/6"

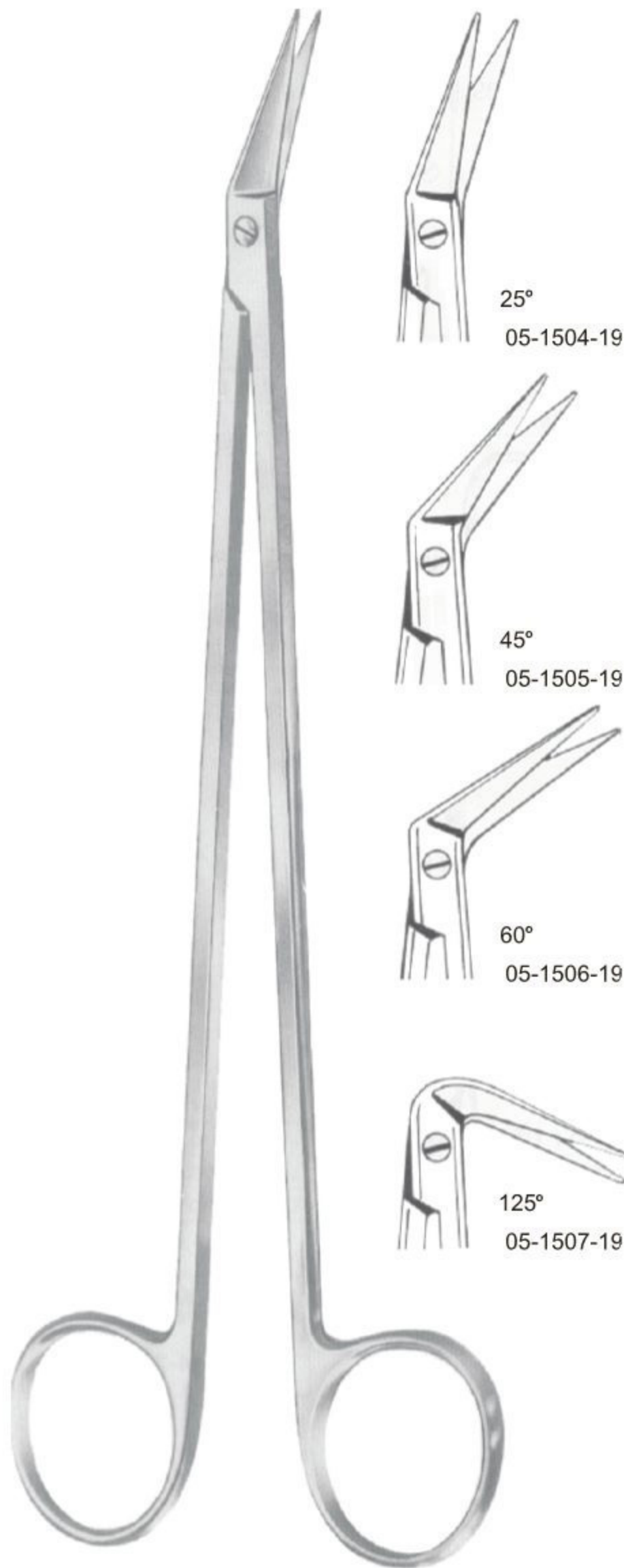

Potts-Smith
 19cm/7½"

25°
 05-1504-19

45°
 05-1505-19

60°
 05-1506-19

125°
 05-1507-19



McIndoe
 05-1508-19
 19cm/7½"



Potts-Smith
 05-1509-19
 19cm/7½"



Satinsky
 05-1510-24
 24.5cm/10"



Klingenberg-Loth
 05-1511-23
 23cm/9"



De Bakey
 18cm/7"

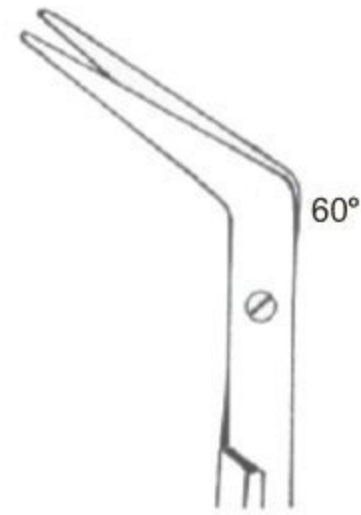
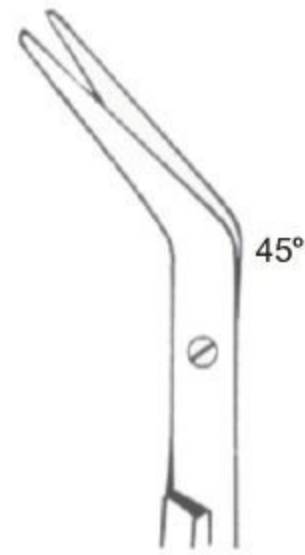
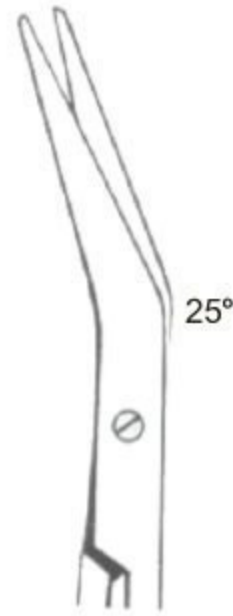

cm	In			
16.0cm	6¼"	05-1512-16	05-1513-16	05-1514-16
23.0cm	9"	05-1512-23	05-1513-23	05-1514-23
28.0cm	11"	05-1512-28	05-1513-28	05-1514-28



Baby-Hegemann
 13.5cm/5¼"
Hegemann (Diethrich)
 16cm/6¼"
 19cm/7½"

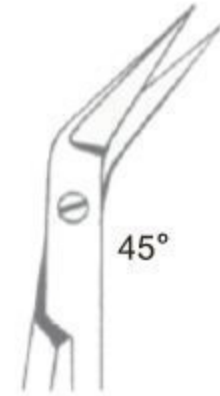

cm	In					
13.0cm	5¼"	05-1515-13	05-1516-13	05-1517-13	05-1518-13	05-1519-13
16.0cm	6¼"	05-1515-16	05-1516-16	05-1517-16	05-1518-16	05-1519-16
19.0cm	7½"	05-1515-19	05-1516-19	05-1517-19	05-1518-19	05-1519-19



Hegemann (Diethrich)
 05-1520-19
 19cm/7½"

Nerve Dissecting Scissors



05-1521-15
 15cm/6"

Tonsil Scissors



Bottcher
 05-1522-18
 18cm/7"



Prince
 05-1523-17
 17.5cm/7"

Arteriotomy Scissors



Tonnis-Adson-Fine
 05-1524-17
 17.5cm/7"

Straight



Tonnis
 05-1525-18
 18cm/7"

Curved



Tonnis
 05-1526-18
 18cm/7"



Tonnis-Adson
 05-1527-17
 17.5cm/7"

Tonsil and Enterotomy Scissors ● EN
 Tonsillen- und Darmscheren ● DE
 Tijeras para henden uñas y nasales ● ES

Tonsil Scissors



Good
 05-1528-19
 19 cm/7½"

Lobectomy Scissors



Crafoord
 05-1529-30
 30 cm/12"



Finochietto
 05-1530-27
 27 cm/10½"

Enterotomy Scissors



05-1531-21
 21 cm/8¼"



05-1532-21
 21 cm/8¼"



05-1533-21
 21 cm/8¼"



Busch
 05-1534-13 13 cm/5"
 05-1534-16 16 cm/6 ¼"



Schumacher
 05-1535-16
 16 cm/6 ¼"



Mod. USA
 05-1536-10
 10.5 cm/4 ¼"



Braun-Stadler
 05-1537-14
 14 cm/5 ½"



Braun-Stadler
 05-1538-22
 22 cm/8 ½"



Straight
 05-1539-12

12cm/4 ¾"



Curved
 05-1540-12

Nasal Scissors ● EN
 Nasenscheren ● DE
 Tijeras para nasales ● ES



Heymann
 05-1541-18
 18 cm/7"



Heymann
 05-1542-19
 19.5 cm/7³/₄"



Knight
 05-1543-18
 18 cm/7"



Fomon
 05-1544-13
 13 cm/5"



Fomon
 05-1545-13
 13.5 cm/5¹/₄"



Fomon
 05-1546-13
 13.5 cm/5¹/₄"



Cottle
 05-1547-16
 16 cm/6¹/₄"



Halle
 05-1548-19
 19 cm/7¹/₄"



Strully
 05-1549-22 22 cm/8 3/4" 05-1550-22



Dandy
 05-1551-22
 17 cm/6 3/4"

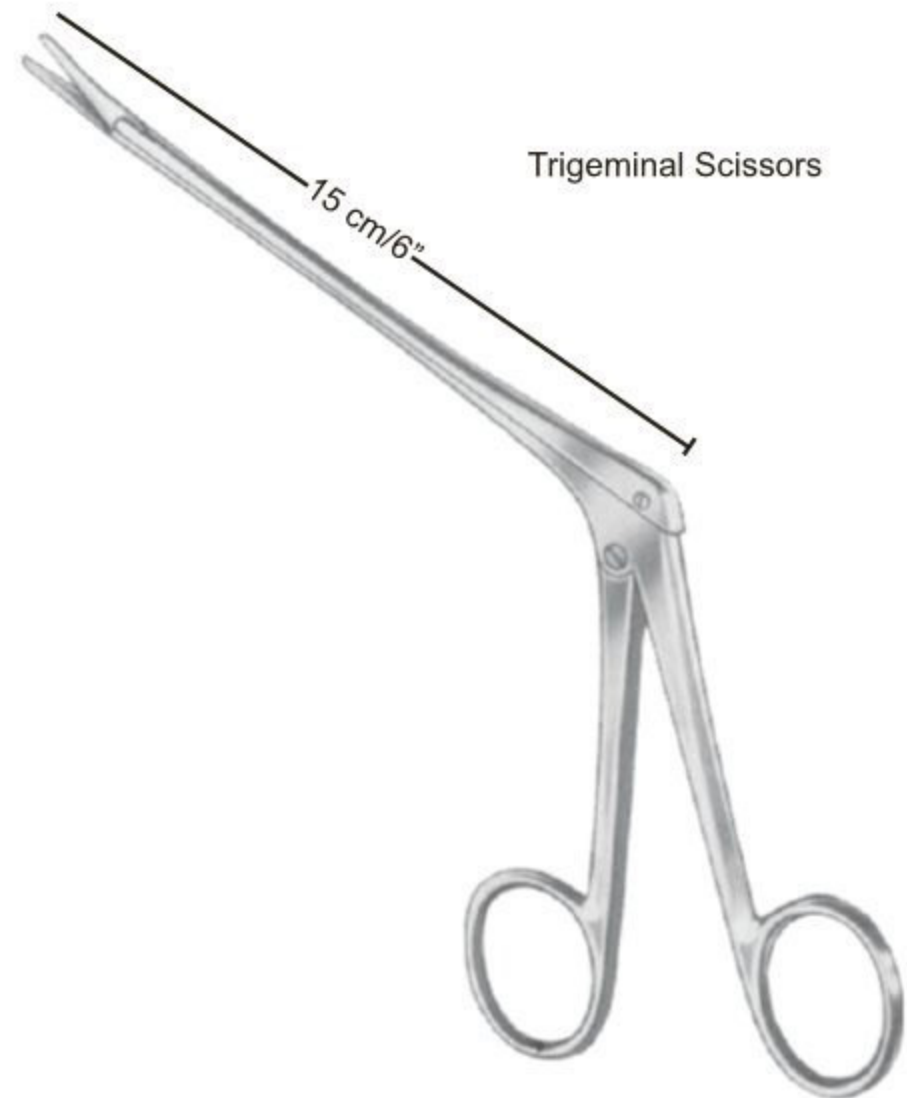

Trigeminal Scissors

Olivecrona
 05-1552-15



11.5cm/4 1/2"

Straight



05-1553-11



05-1554-11

Curved



05-1555-11



05-1556-11



Knapp
 10.5cm/4 1/4"

Straight



05-1557-10



05-1558-10



05-1559-10

Curved



05-1560-10



05-1561-10



05-1562-10

Eye Scissors ● EN
 Augen Scheren ● DE
 Tijeras ojo ● ES



Standard

9.0 cm/3½"	05-1563-09	05-1564-09	05-1565-09	05-1566-09
10.5 cm/4¼"	05-1563-10	05-1564-10	05-1565-10	05-1566-10
11.5 cm/4½"	05-1563-11	05-1564-11	05-1565-11	05-1566-11



Fine

Fine

9.0cm/3¾"			05-1569-09	05-1570-09
10.5cm/4¼"	05-1567-10	05-1568-10	05-1569-10	05-1570-10
11.5cm/4½"	05-1567-11	05-1568-11	05-1569-11	05-1570-11



Straight
Fine

9.5 cm/3¾"	05-1571-09
10.5 cm/4¼"	05-1571-10
11.5 cm/4½"	05-1571-11



Curved
Fine

05-1572-09
05-1572-10
05-1572-11



Straight

05-1573-10

Curved

10cm/4" 05-1574-10

Tenotomy Scissors



10.5cm/4¼"
 11.5cm/4½"



Pointed

Straight
05-1575-10
05-1575-11



Curved
05-1576-10
05-1576-11



Blunt

Straight
05-1577-10
05-1577-11



Curved
05-1578-10
05-1578-11

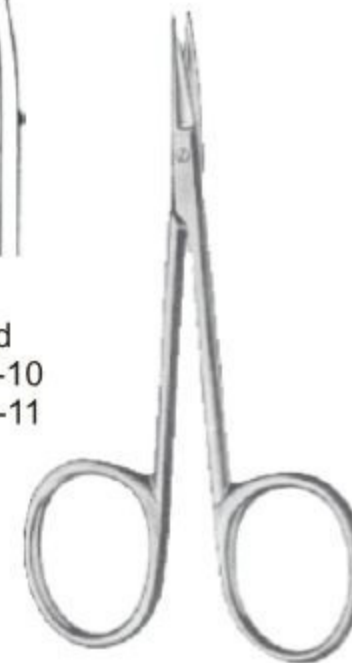

Straight
 05-1579-08



Bonn
 8cm/3¼" Curved
 05-1580-08

Eye Scissors ● EN
 Augen Scheren ● DE
 Tijeras ojo ● ES



Graefe
 05-1581-10
 10.5cm/4¼"



Wilmer
 05-1582-10
 10cm/4"



05-1583-11

11.5cm/4½"



05-1584-11



La Grange
 05-1585-11
 11.5cm/4½"



Chadwick
 05-1586-11
 11cm/4½"

Neurosurgical Scissors

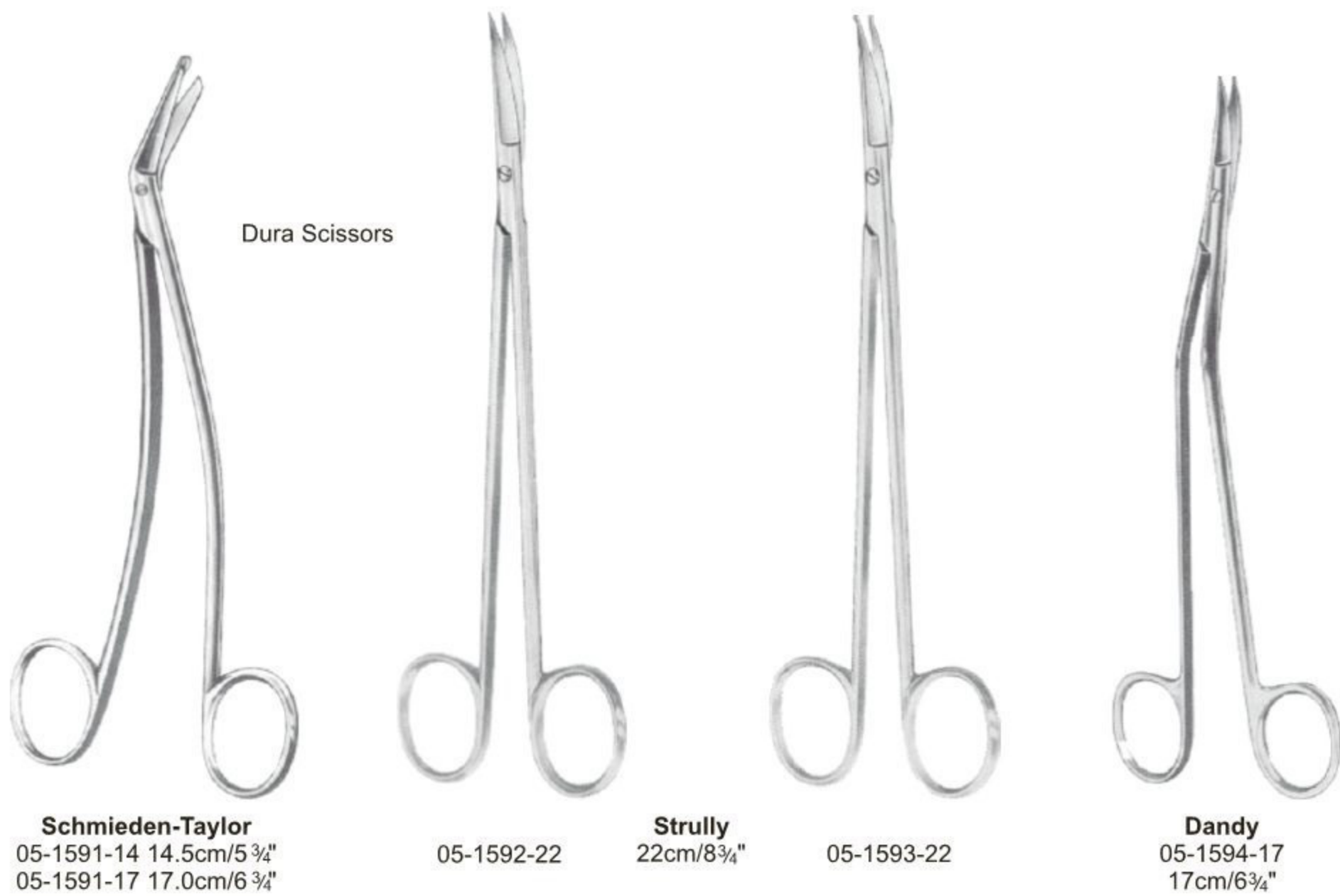
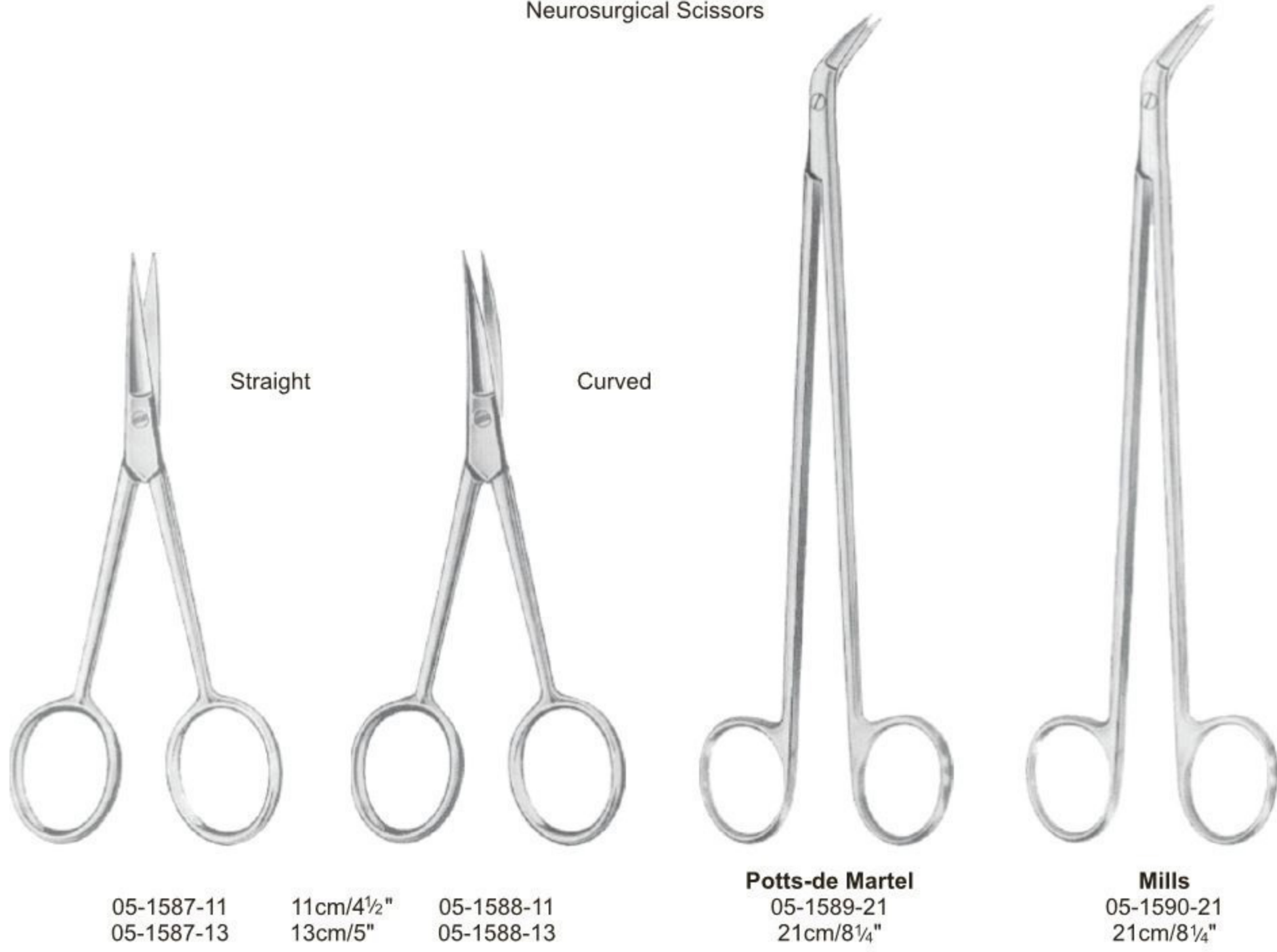

Ligature Scissors ● EN
 Ligaturscheren Fadenscheren ● DE
 Tijeras para Ligaduras ● ES



Littauer
 05-1595-14
 14cm/5½"



Spencer
 05-1596-09
 9cm/3½"



Spencer
 05-1597-10 10.5cm/4¼"
 05-1597-12 12.0cm/4¾"



Spencer-Fine
 05-1598-11 11.5cm/4½"
 05-1598-16 16cm/6¼"



Shortbent
 05-1599-09
 9cm/3½"



Northbent
 05-1600-12
 12.5cm/5"



Spencer
 05-1601-11
 11.5cm/4½"



Littler
 05-1602-11
 11.5cm/4½"



Heath
 05-1603-15
 15cm/6"



05-1604-10
 10cm/4"



Eiselsberg
 05-1605-11
 11.5cm/4½"



Schoemaker-Loth
 05-1606-12
 12.5cm/5"

Wire Cutting Scissors



Universal
 05-1607-12
 12cm/4¾"

Saw Edge



	Universal	Universal	Universal
Black	05-1608-01	05-1609-01	05-1610-01
Blue	05-1608-02	05-1609-02	05-1610-02
Red	05-1608-03	05-1609-03	05-1610-03
Green	05-1608-04	05-1609-04	05-1610-04

14.5 cm/5¾"

16 cm/6¼"

18 cm/7"



Smith
 05-1611-17
 17.5 cm/7"



Harvey
 05-1612-12
 12.5 cm/5"



Schuknecht
 05-1613-10
 10 cm/4"

Nail Splinting Scissors



05-1614-13 13 cm/5"
 05-1614-15 15 cm/6"



Lister

05-1615-09 09.0 cm/3 1/2"
 05-1615-11 11.5 cm/4 1/2"
 05-1615-14 14.0 cm/5 1/2"
 05-1615-15 15.5 cm/6"
 05-1615-18 18.0 cm/7"
 05-1615-20 20.0 cm/8"



Lister

05-1616-18 18.5 cm/7 1/4"
 05-1616-21 21.0 cm/8 1/4"



Lister-Excentric

05-1617-16 16 cm/6 1/4"
 05-1617-19 19 cm/7 1/2"



Esmarch

05-1618-20 20 cm/8"
 05-1618-22 22 cm/8 3/4"



Bergmann

05-1619-23
 23 cm/9"



Lorenz

05-1620-23
 23 cm/9"

Bandage Scissors ● EN
 Verbandschere ● DE
 Tijeras vendaje ● ES



Saw edge

05-1621-17
 17 cm/6¾"



Lange
 05-1622-18
 18 cm/7"



Bruns
 05-1623-24 24 cm/9½" Saw edge
 05-1624-24 24 cm/9½" Smooth
 05-1625-24 24 cm/9½" TC



Smith (Mod. USA)
 05-1626-18 18 cm/7"
 05-1626-20 20 cm/8"
 05-1626-23 23 cm/9"



Knowles
 05-1627-14
 14 cm/5½"



Knowles
 05-1628-14
 14 cm/5½"



05-1629-13
 13 cm/5"

- EN —● Clothing Scissors, Plaster of Paris and Rib Shears
- DE —● Bekleidung Schere, Plaster of Paris und Rib Shears
- ES —● Tijeras ropa, yeso y tijeras Costilla



05-1630-20
 20 cm/8"



Seutin
 05-1631-23
 23 cm/9"



05-1632-23
 23 cm/9"



Collin
 05-1633-22
 22 cm/8¾"



Gluck
 05-1634-22
 22 cm/8¾"



Stille
 05-1635-21
 21 cm/8¼"



Stille
 05-1636-24
 24 cm/9½"



Stille
 05-1637-23 23 cm/9"
 05-1637-26 26 cm/10¼"
 05-1637-37 37 cm/14½"

- Crown Scissors ● EN
- Crown shears ● DE
- corona Tijeras ● ES

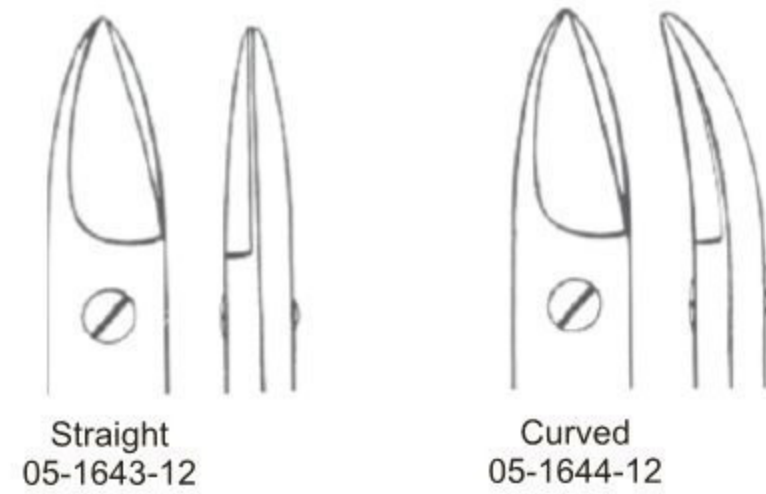



Goldmann-Fox
 05-1645-13
 13 cm/5"

Saw edge



Goldmann-Fox
 05-1646-13
 13 cm/5"



Niro
 05-1647-14
 14 cm/5½"



Goldmann-Fox
 (Spezial)
 05-1648-13
 13 cm/5"

Saw edge



05-1649-11
 11.5 cm/4½"

Fine



Quinby
 05-1650-12
 12 cm/4¾"



Quinby
 05-1651-12
 12 cm/4¾"

Gum Scissors ● EN
 Gum Schere ● DE
 Tijeras de las encías ● ES



Dean
 05-1652-17
 17 cm/6¾"



Dean
 05-1653-17
 17 cm/6¾"



Locklin
 05-1654-16
 16.5 cm/6½"



Locklin
 05-1655-16
 16.5 cm/6½"



Sullivan
 05-1656-14
 14.5 cm/5¾"



Sullivan
 05-1657-14
 14.5 cm/5¾"



Neumann
 05-1658-12
 12.5 cm/5"



La Grange
 05-1659-11
 11.5 cm/4½"



05-1660-11 **Standard** 11.5 cm/4½" 05-1661-11 05-1662-11 **Standard** 11.5 cm/4½" 05-1663-11 **Chadwick** 05-1664-11 11.5 cm/4½"

Nail scissors



09.0 cm/3½" 05-1665-09 05-1666-09 05-1667-09 05-1668-09
 10.5 cm/4¼" 05-1665-10 05-1666-10 05-1667-10 05-1668-10

Micro Scissors ● EN
 Mikroscheren ● DE
 Micro-Tijeras ● ES



Fig. 1



Fig. 2



Fig. 3

Noyes
 Fig.1 05-1669-01
 Fig.2 05-1669-02
 Fig.3 05-1669-03
 12 cm/4 3/4"



Noyes
 05-1670-12
 12 cm/4 3/4"



Wecker
 11.5 cm/4 1/2"



05-1671-01



05-1671-02



Barraquer
 05-1672-05
 5.5 cm/2 1/4"



05-1673-09
 9 cm/3 "



05-1674-09



05-1675-09



05-1676-09



05-1677-09



05-1678-09

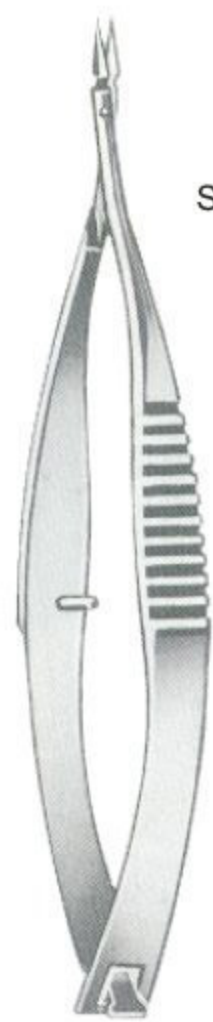

Straight

Vannas
 05-1679-08
 8 cm/3¼"

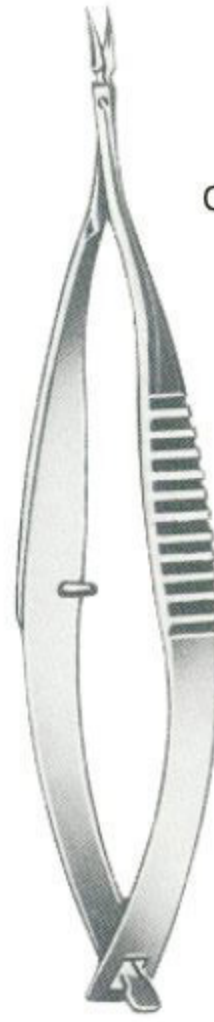

Curved

Vannas
 05-1680-08
 8 cm/3¼"

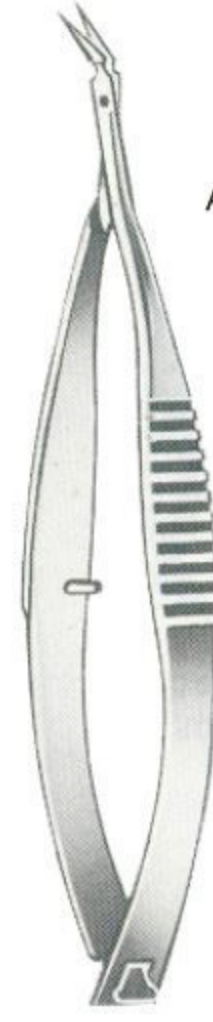

Angular

Vannas
 05-1681-08
 8 cm/3¼"

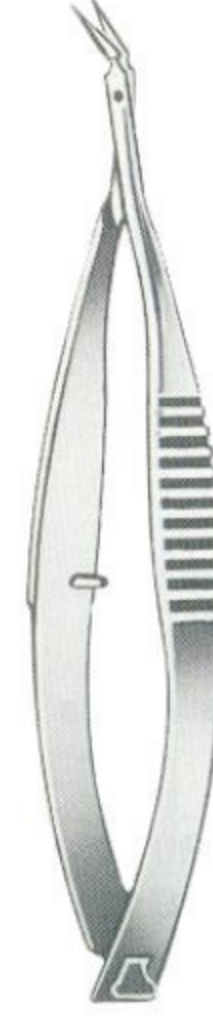

Vannas
 05-1682-08
 8 cm/3¼"



Straight

05-1683-08
 8.5 cm/3¼"

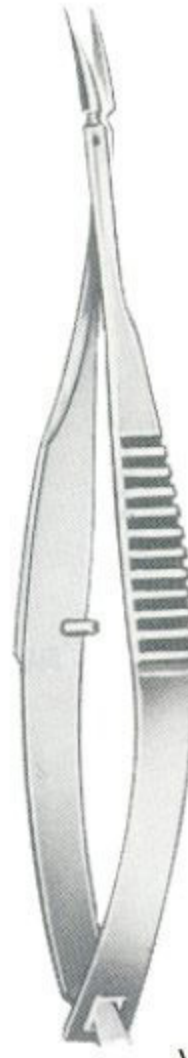

Curved

05-1684-08
 8.5 cm/3½"

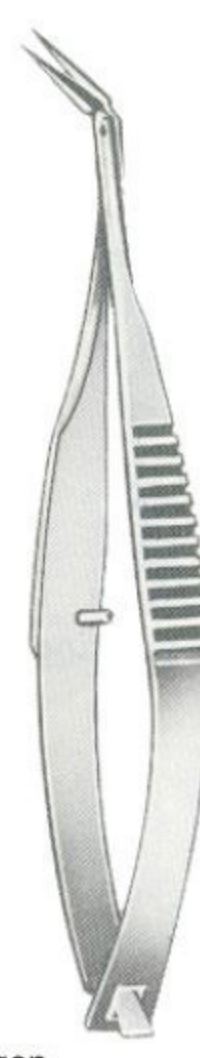

Angular

05-1685-08
 8.5 cm/3½"

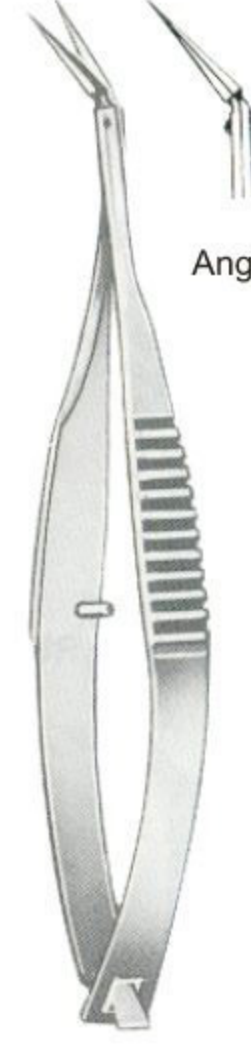

Angular

05-1686-08
 8.5 cm/3½"

Vannas Mod, Tubingen

Micro Scissors ● EN
 Mikroscheren ● DE
 Micro-Tijeras ● ES



05-1687-10
 10 cm/4"



05-1688-10
 10 cm/4"



Castroviejo
 05-1689-10
 10 cm/4"



Castroviejo
 05-1690-10
 10 cm/4"



Aebli
 05-1691-10
 10 cm/4"

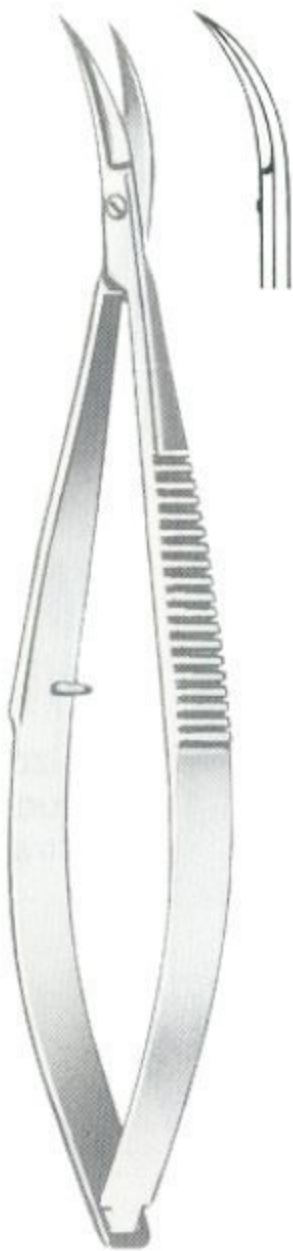

Castroviejo
 05-1692-10
 10 cm/4"

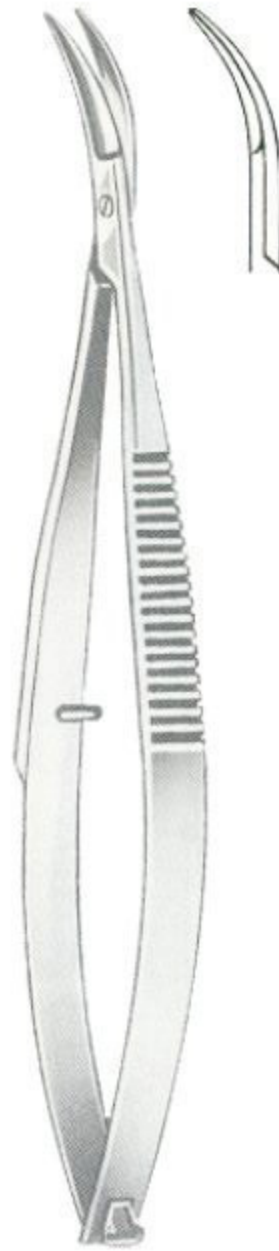

Castroviejo
 05-1693-10
 10 cm/4"

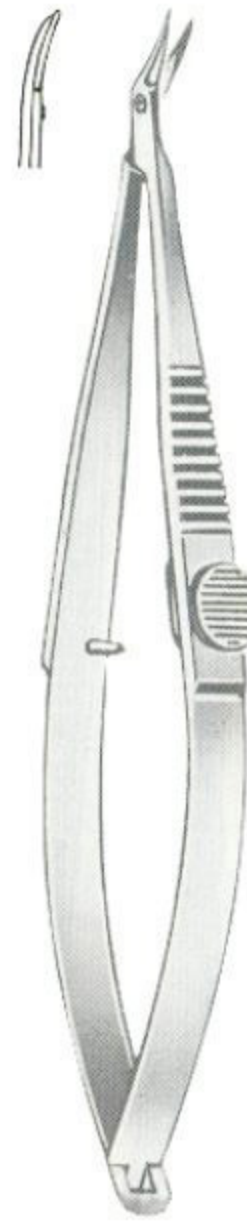

Troutman-Barraquer
 05-1694-10
 10 cm/4"

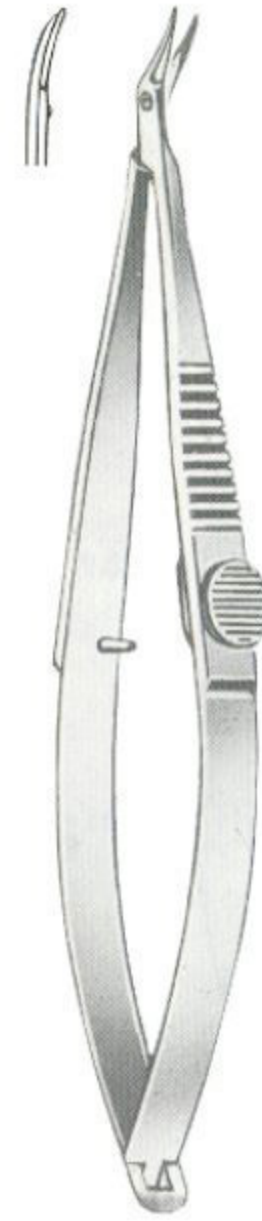

Troutman-Barraquer
 05-1695-10
 10 cm/4"

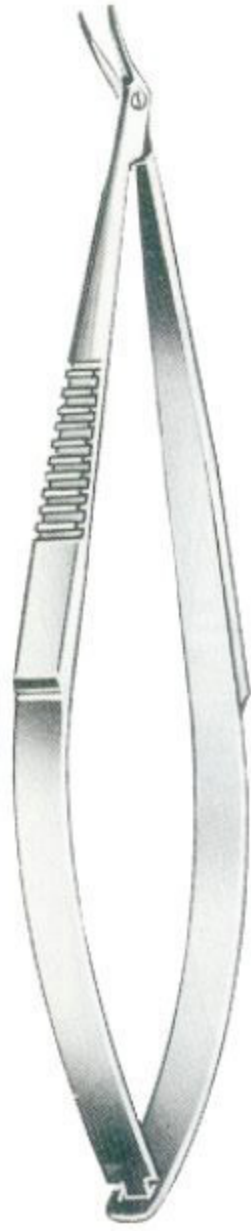

Troutman
 05-1696-10
 10 cm/4"

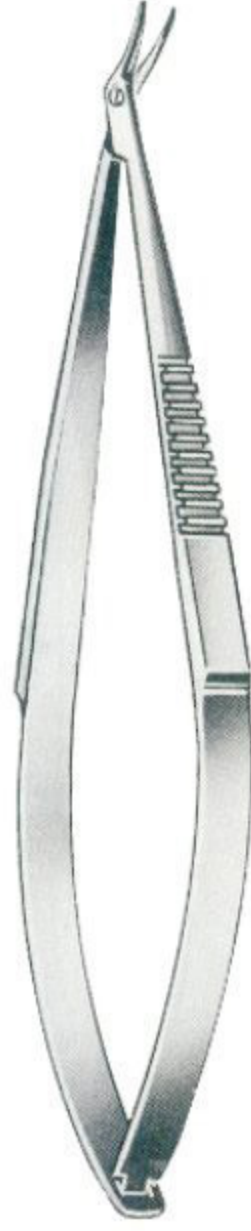

Troutman
 05-1697-10
 10 cm/4"



Katzin-Barraquer
 05-1698-10
 10 cm/4"

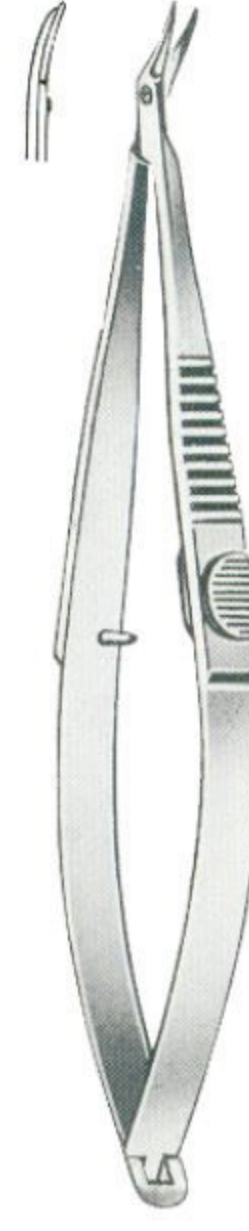

Katzin-Barraquer
 05-1699-10
 10 cm/4"

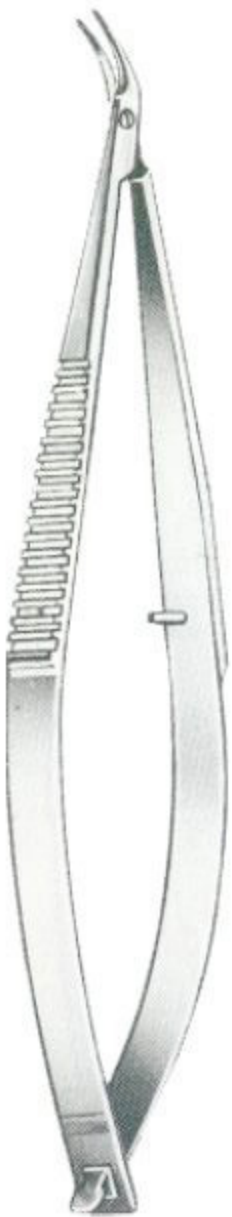

Katzin
 05-1700-11
 10 cm/4"

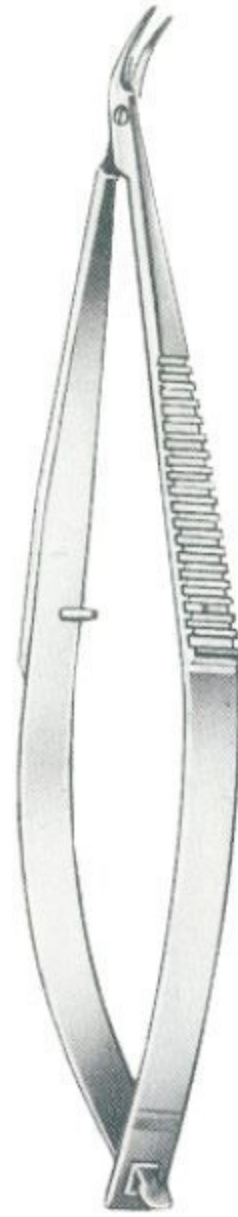

Katzin
 05-1701-11
 10 cm/4"

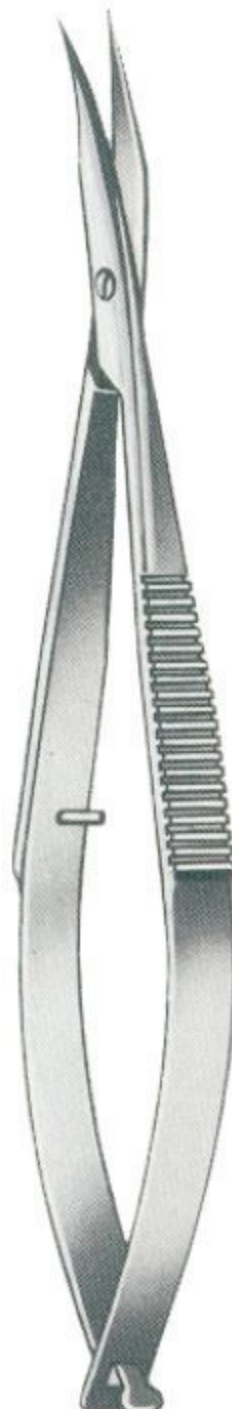

Westcott
 05-1702-11
 11 cm/4 "

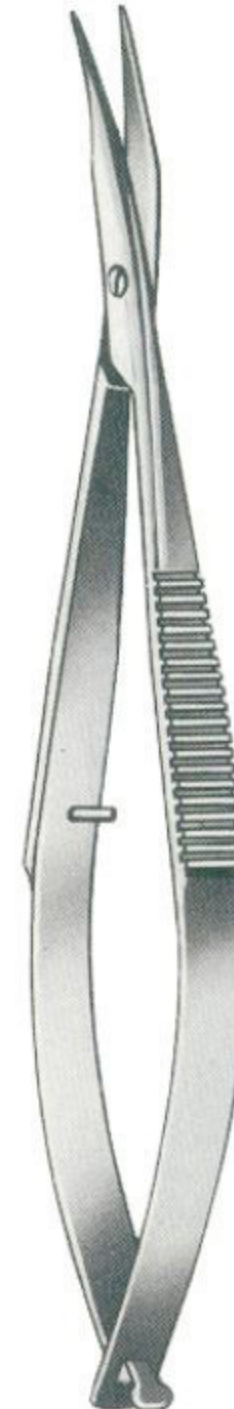

Westcott
 05-1703-11
 11 cm/4 "



Westcott
 05-1704-11
 11 cm/4 "

Micro Scissors ● EN
 Mikroscheren ● DE
 Micro-Tijeras ● ES

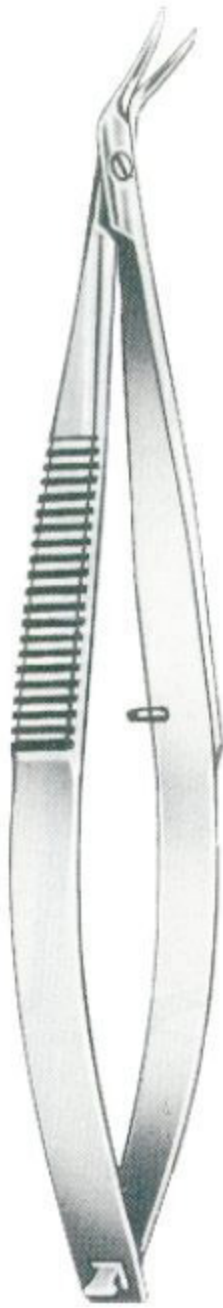

Castroviejo
 05-1705-10
 10 cm/4"

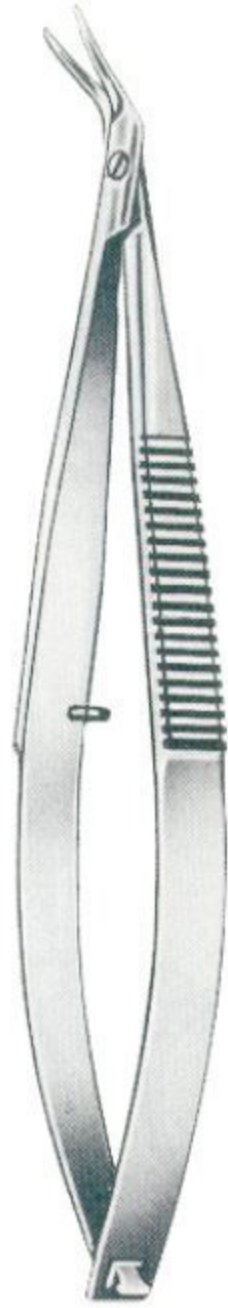

Castroviejo
 05-1706-10
 10 cm/4"



Castroviejo
 05-1707-11
 11.5 cm/4½"

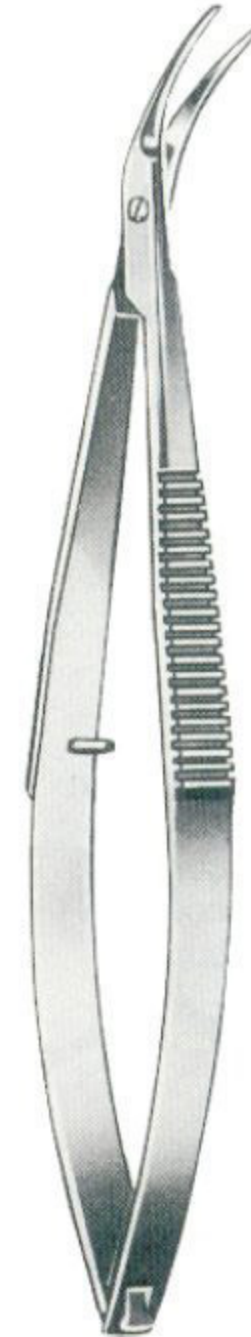

Castroviejo
 05-1708-11
 11.5 cm/4½"



Troutmann-Castroviejo
 05-1709-10
 10.5 cm/4¼"



Troutmann-Castroviejo
 05-1710-10
 10.5 cm/4¼"



14.5 cm/5¾"
 18.0 cm/7"

Straight
 05-1711-14
 05-1711-18

Curved
 05-1712-14
 05-1712-18

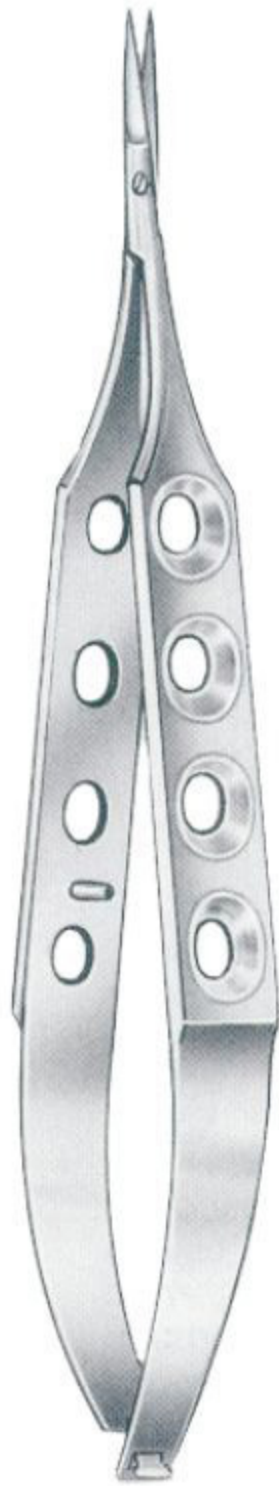

Straight

05-1713-12	12.0 cm/4 ³ / ₄ "
05-1713-16	16.0 cm/6 ¹ / ₄ "
05-1713-18	18.5 cm/7 ¹ / ₄ "



Curved

05-1714-12	12.0 cm/4 ³ / ₄ "
05-1714-16	16.0 cm/6 ¹ / ₄ "
05-1714-18	18.5 cm/7 ¹ / ₄ "

Vannas
Straight

05-1715-12	12.0 cm/4 ³ / ₄ "
05-1715-16	16.0 cm/6 ¹ / ₄ "

Vannas
Curved

05-1716-12	12.0 cm/4 ³ / ₄ "
05-1716-16	16.0 cm/6 ¹ / ₄ "

Micro Scissors ● EN
 Mikroscheren ● DE
 Micro-Tijeras ● ES



Yasargil

16.5cm/6½"
 20.0cm/8"

20.0cm/8"

20.0cm/8"



Straight
 05-1717-16
 05-1717-20



Curved
 05-1718-16
 05-1718-20



Curved Downwards
 05-1719-20

Dissecting Scissors



Straight
 05-1720-20



Curved
 05-1721-20



Yasargil

22.5cm/9"
 24.5cm/9¾"

22.5cm/9"

22.5cm/9"



Straight
 05-1722-22
 05-1722-24



Curved
 05-1723-22
 05-1723-24



Curved Downwards
 05-1724-22

Dissecting Scissors



Straight
 05-1725-22



Curved
 05-1726-22

Micro Scissors ● EN
 Mikroscheren ● DE
 Micro-Tijeras ● ES

05-1727-18



05-1730-19

05-1728-18



05-1731-19

05-1729-18



05-1732-19



05-1733-19

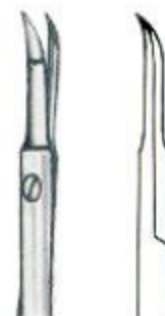

05-1734-19



Jacobson
18cm/7"



19cm/7½"

Vein Scissors

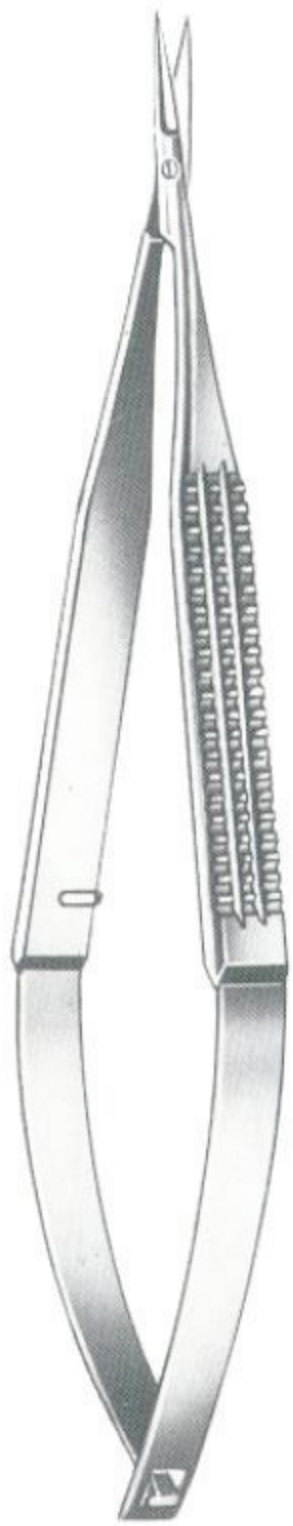

Straight
 05-1735-12
 12cm/4 3/4"

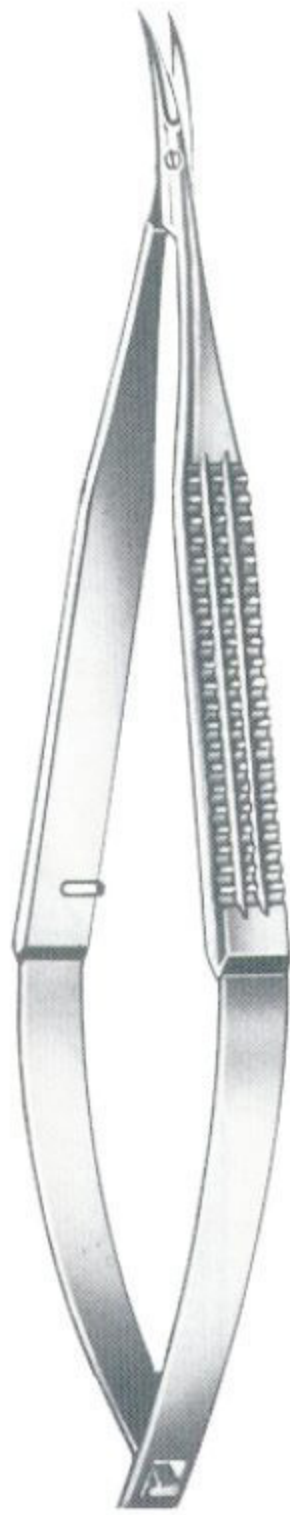

Curved
 05-1736-12
 12cm/4 3/4"

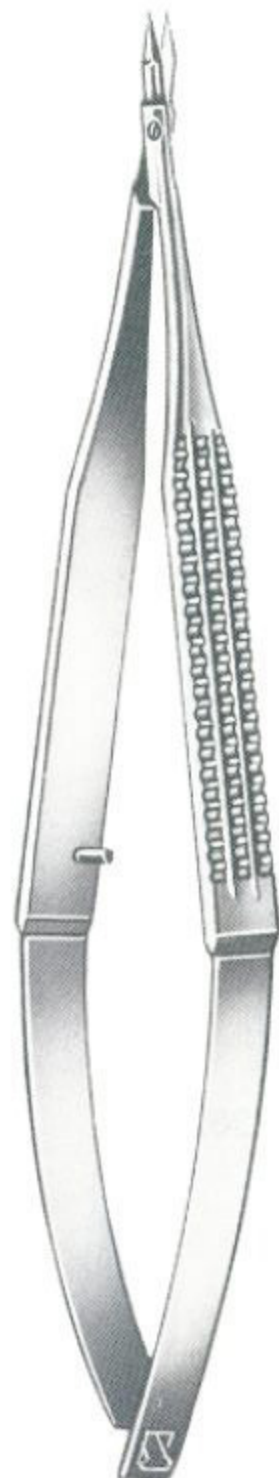

Straight
 05-1737-12
 12cm/4 3/4"

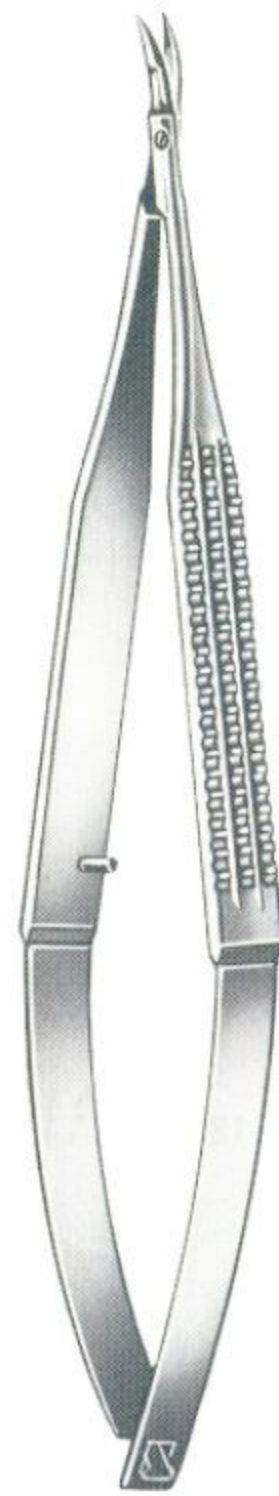

Curved
 05-1738-12
 12cm/4 3/4"



Angled up
 05-1739-12
 12cm/4 3/4"

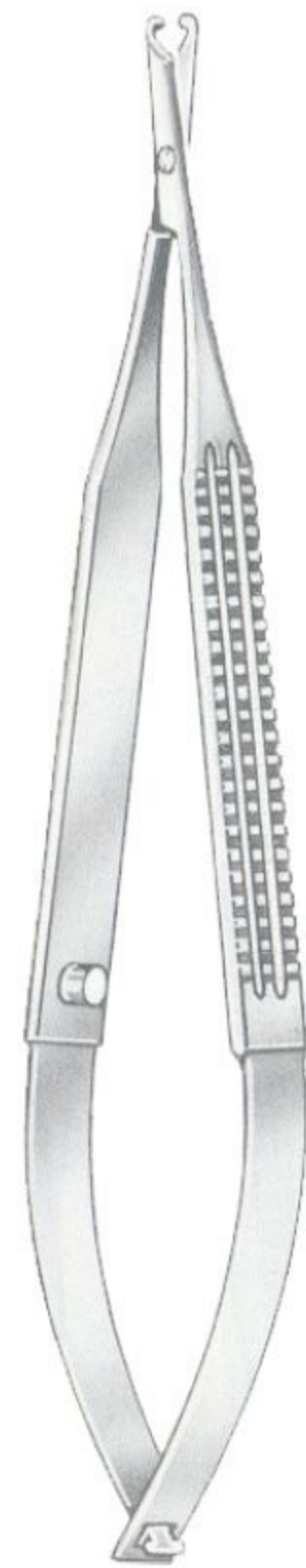

Straight
 105-1740-13
 13cm/5 1/8"

Micro Scissors ● EN
 Mikroscheren ● DE
 Micro-Tijeras ● ES



Saw Edge

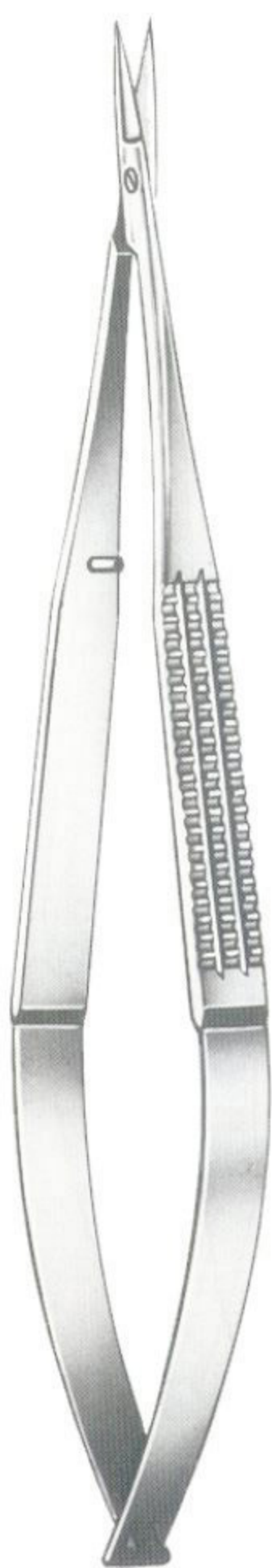

Straight
 105-1741-16
 16cm/6¼"

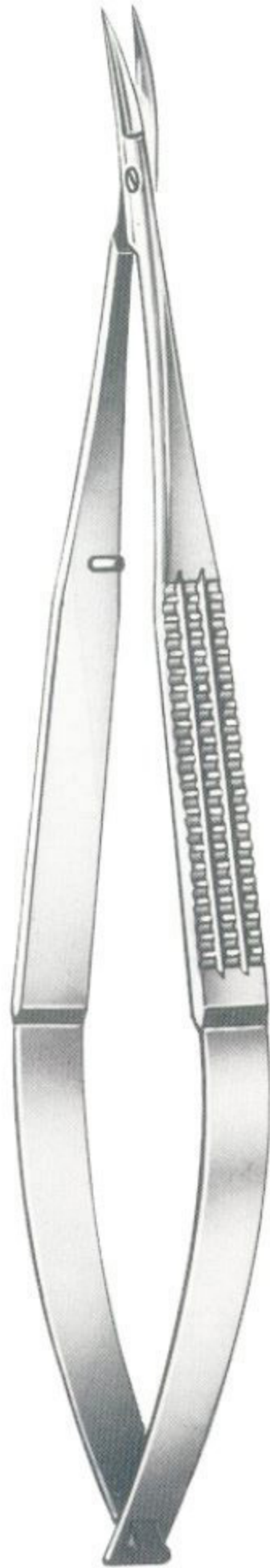

Curved
 105-1742-16
 16cm/6¼"

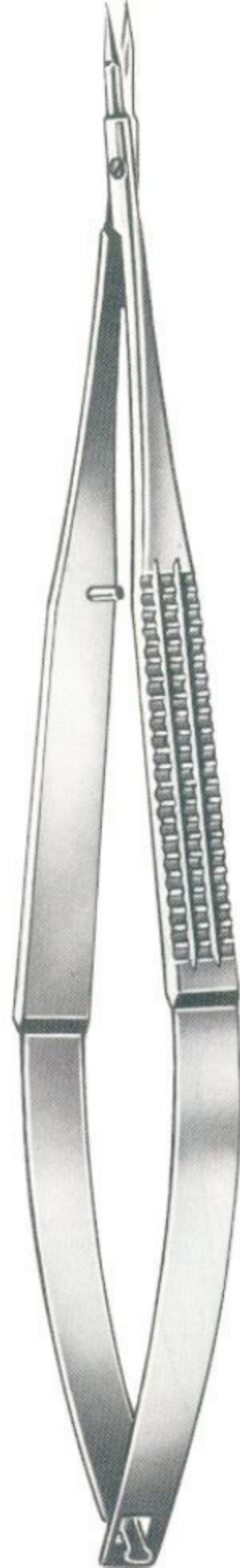

Straight
 105-1743-16
 16cm/6¼"

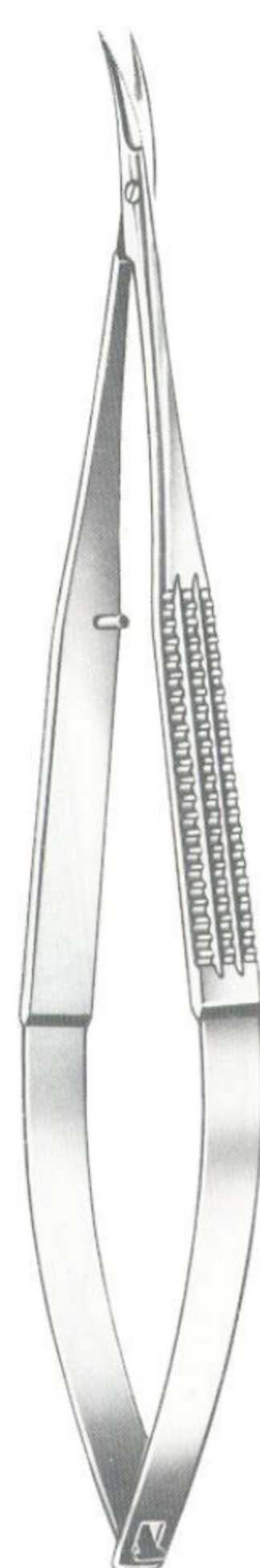

Curved
 105-1744-16
 16cm/6¼"

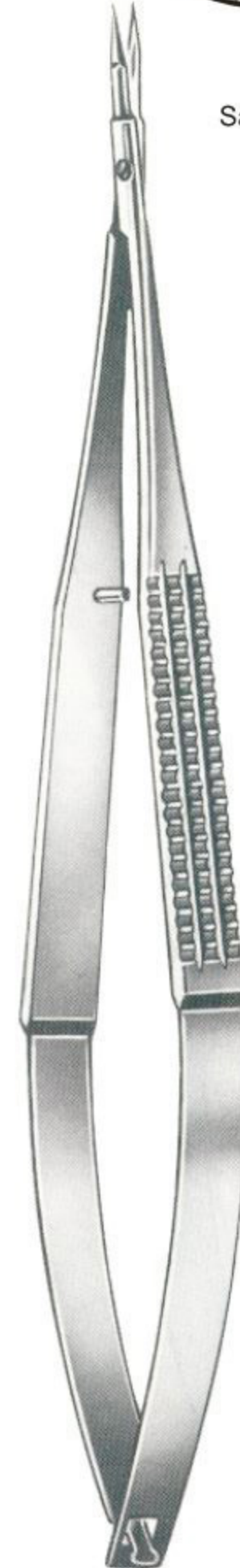

Millesi
 Straight
 105-1745-16
 16cm/6¼"

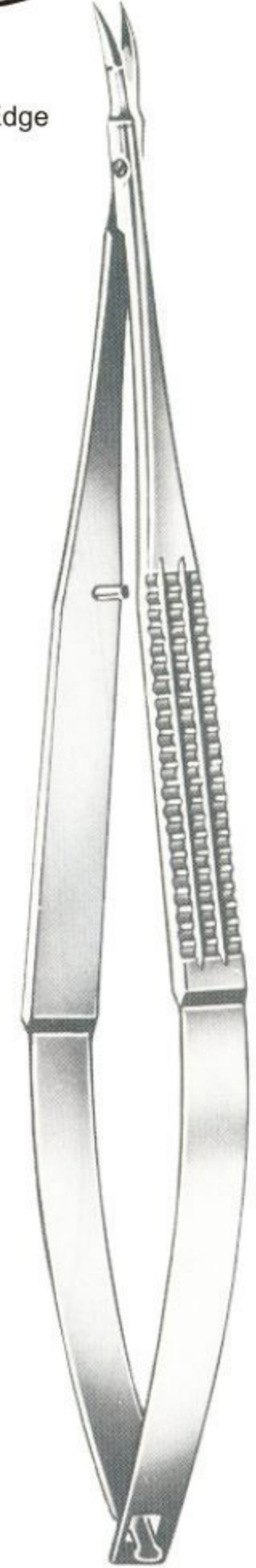

Millesi
 Curved
 105-1746-16
 16cm/6¼"



Straight
105-1747-18
18.5cm/7¼"

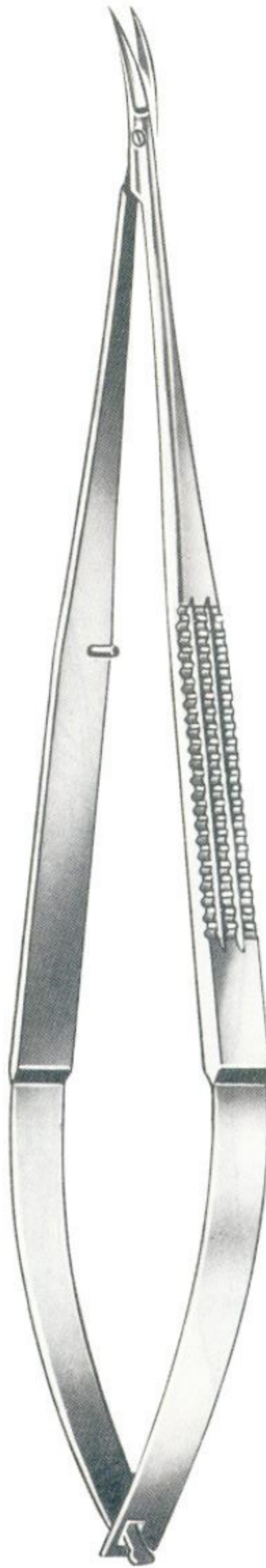

Curved
105-1748-18
18.5cm/7¼"

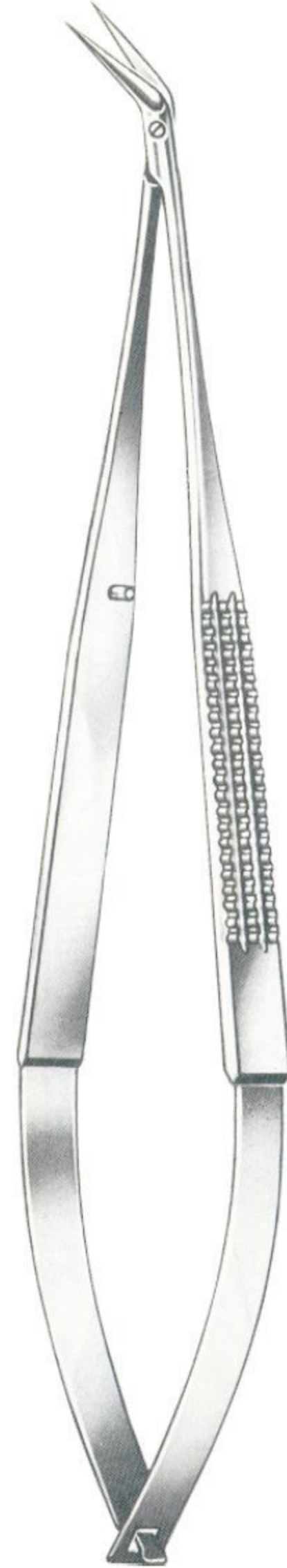

Angular
105-1749-18
18.5cm/7¼"

Micro Scissors ● EN
 Mikroscheren ● DE
 Micro-Tijeras ● ES

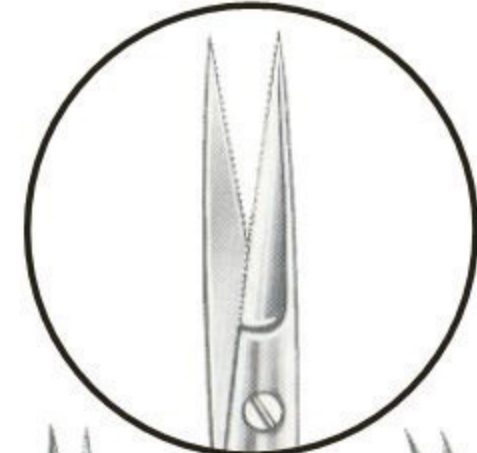

Saw Edge



Straight
 105-1750-16
 16cm/6¼"



Curved
 105-1751-16
 16cm/6¼"



Straight
 105-1752-16
 16cm/6¼"



Curved
 105-1753-16
 16cm/6¼"



Straight
 105-1754-16
 16cm/6¼"



Curved
 105-1755-16
 16cm/6¼"



Straight
 105-1756-18
 18.5cm/7¼"



Curved
 105-1757-18
 18.5cm/7¼"



Angular
 105-1758-18
 18.5cm/7¼"



Straight
 105-1759-22

Micro Scissors ● EN
 Mikroscheren ● DE
 Micro-Tijeras ● ES



Straight
 105-1760-14
 14.5cm/5¾"



Curved
 105-1761-14
 14.5cm/5¾"

Dissecting Scissors



Curved
 105-1762-14
 14.5cm/5¾"



Operating Scissor

Straight	Curved
05-1763-14	05-0682-14
14.5cm/5¾"	



Mayo

Straight	Curved
05-1764-14	05-1765-14
05-1764-17	05-1765-17
05-1764-23	05-1765-23
14.5cm/5¾"	17.0cm/6¾"
17.0cm/6¾"	23.0cm/9"



Mayo-Stille

Straight	Curved
05-1766-15	05-1767-15
05-1766-17	05-1767-17
15.0cm/6"	17.0cm/6¾"



Lexer

Straight	Curved
05-1768-16	05-1769-16
16cm/6¼"	



Baby-Metzenbaum

Straight	Curved
05-1770-11	05-1771-11
11.5cm/4½"	



Metzenbaum-Fine

Straight	Curved
05-1772-14	05-1773-14
14.5cm/5¾"	



Metzenbaum-Fine

Straight	Curved
05-1774-18	05-1775-18
05-1774-20	05-1775-20
05-1774-23	05-1775-23
18cm/7"	20cm/8"
20cm/8"	23cm/9"

Dissecting Scissors ● EN
 Präparierscheren ● DE
 Tijeras para preparacionesa ● ES

**Sims**

Straight		Curved
05-1776-20	20 cm/8"	05-1777-20
05-1776-23	23 cm/9"	05-1777-23

**Siebold**

05-1778-24
 24 cm/9½"

**Jameson**

05-1779-15 15 cm/6"
 05-1779-18 18 cm/7"

**Reynolds**

Straight	Curved
05-1780-15	05-1781-15
	15 cm/6"



Straight	Curved
05-1782-11	05-1783-11
	11.5 cm/4½"



Straight	Curved
05-1784-11	05-1785-11
	11.5 cm/4½"

**Plastic Surgery**

Straight	Curved
05-1786-12	05-1787-12
	12 cm/4¾"

**Wagner**

Straight	Curved
05-1788-12	05-1789-12
	12 cm/4¾"



05-1790-11
 11.5 cm/4½"



05-1791-14
 14cm/5½"



Reynolds
 05-1792-13
 13cm/5"

Endarterectomy
 Scissors



Potts-Smith
 19cm/7½"



25°
 05-1793-19



45°
 05-1794-19



60°
 05-1795-19



05-1796-17
 17cm/6¾"

Bandage Scissors, Nasal Scissors ●— EN
 Verbandschere, Nasenschere ●— DE
 Tijeras para vendas, tijeras nasales ●— ES



Lister
 05-1797-14 14.5cm/5¾"
 05-1797-18 18cm/7"
 05-1797-20 20cm/8"



Braun-Stadler
 05-1798-14 14.5cm/5¾"
 05-1798-22 22cm/8¾"



Stevens
 Straight 05-1799-11 11.5cm/4½"
 Curved 05-1800-11



Heymann
 05-1801-18
 18cm/7"



Fomon
 05-1802-13
 13cm/5"



Fomon
 05-1803-13
 13cm/5"



Cottle
 05-1804-16
 16cm/6¼"



Standard
 14.5cm/5¾"



Fig. 1
 05-1805-14



Fig. 2
 05-1806-14



Fig. 3
 05-1807-14

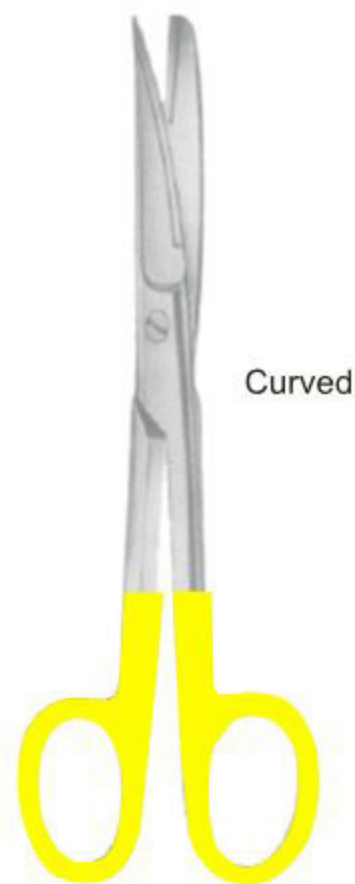

Standard
 14.5cm/5¾"

Curved



Fig. 1
 05-1808-14



Fig. 2
 05-1809-14



Fig. 3
 05-1810-14



Lexer
 Straight
 05-1811-16
 16 cm/6¼"



Lexer
 Curved
 05-1812-16
 16 cm/6¼"



Mayo
 Straight
 05-1813-14 14.5 cm/5¾"
 05-1813-18 18.0 cm/7"
 05-1813-23 23.0 cm/9"



Mayo
 Curved
 05-1814-14 14.5 cm/5¾"
 05-1814-18 18.0 cm/7"
 05-1814-23 23.0 cm/9"



Lexer-Fine
 Straight
 005-1815-16
 16 cm/6¼"



Lexer-Fine
 Curved
 05-1816-16
 16 cm/6¼"



Mayo-Stille
 Straight
 05-1817-15 15 cm/6"
 05-1817-17 17 cm/6¾"



Mayo-Stille
 Curved
 05-1818-15 15 cm/6"
 05-1818-17 17 cm/6¾"

Straight



Metzenbaum
 05-1819-14
 14.5 cm/5¾"



Metzenbaum-Fine
 05-1820-14
 14.5 cm/5¾"



Metzenbaum-Fine
 05-1821-14
 14.5 cm/5¾"

Curved



Metzenbaum
 05-1822-14
 14.5 cm/5¾"



Metzenbaum-Fine
 05-1823-14
 14.5 cm/5¾"



Metzenbaum-Fine
 05-1824-14
 14.5 cm/5¾"

Dissecting and Operating Scissors ● EN
 Präparierscheren, Chirurgische Scheren ● DE
 Tijeras para preparaciones, Tijeras para cirugía ● ES

Straight

**Metzenbaum**

18 cm/7"	05-1825-18
20 cm/8"	05-1825-20
23 cm/9"	05-1825-23
25 cm/10"	05-1825-25
28 cm/11"	05-1825-28
30 cm/12"	05-1825-30

**Metzenbaum-Fine**

05-1826-18
05-1826-20
05-1826-23
05-1826-25
05-1826-28
05-1826-30

**Metzenbaum-Fine**

05-1827-18
05-1827-20
05-1827-23
05-1827-25
05-1827-28
05-1827-30

Curved

**Metzenbaum**

18 cm/7"	05-1828-18
20 cm/8"	05-1828-20
23 cm/9"	05-1828-23
25 cm/10"	05-1828-25
28 cm/11"	05-1828-28
30 cm/12"	05-1828-30

**Metzenbaum-Fine**

05-1829-18
05-1829-20
05-1829-23
05-1829-25
05-1829-28
05-1829-30

**Metzenbaum-Fine**

05-1830-18
05-1830-20
05-1830-23
05-1830-25
05-1830-28
05-1830-30

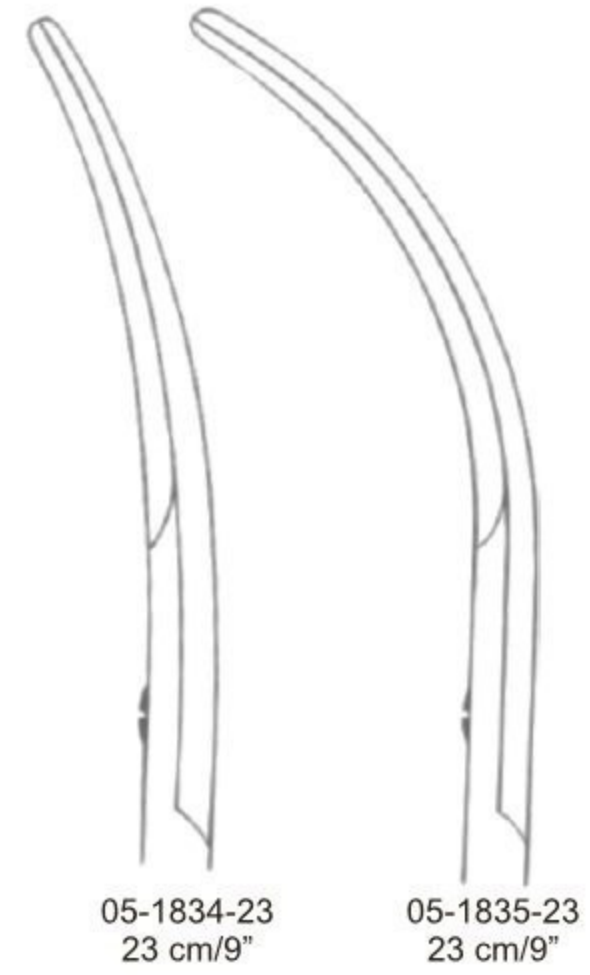
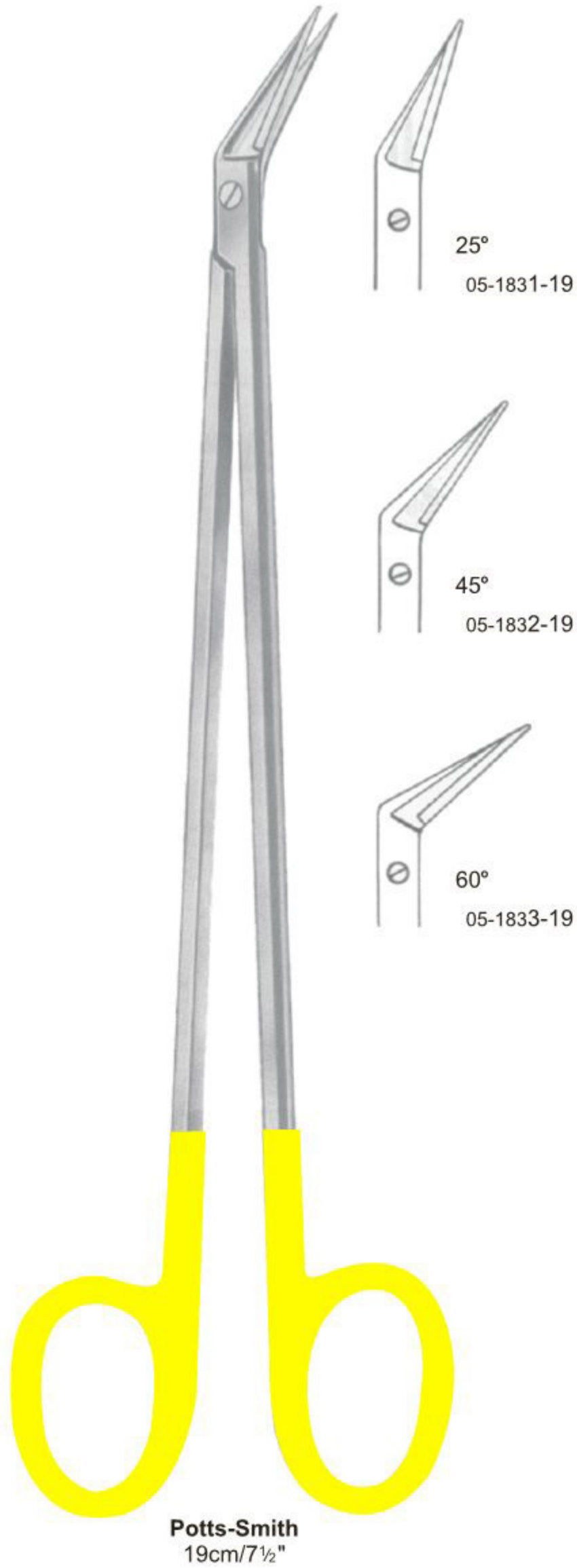

Sims
 05-1836-20 20 cm/8"
 05-1836-23 23 cm/7"

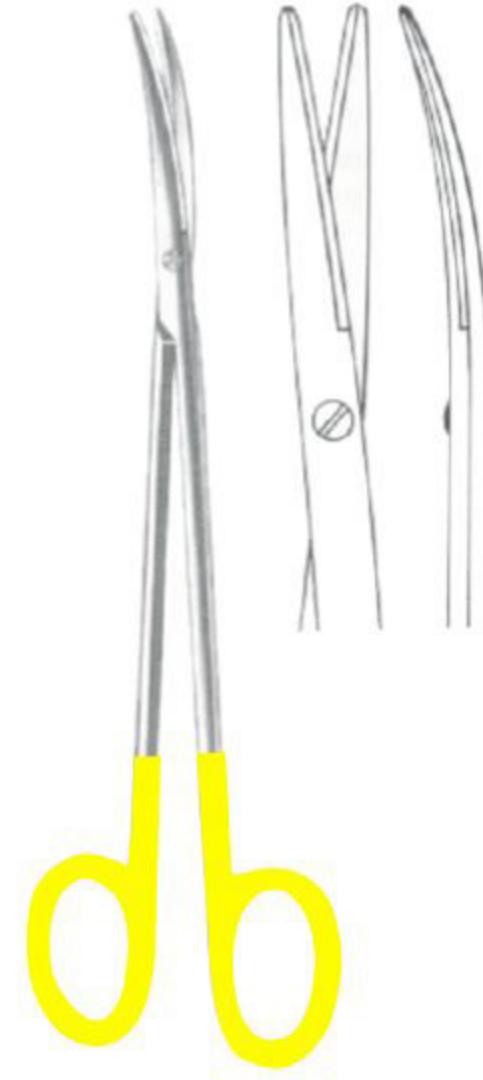

Tonnis-Adson
 05-1837-17
 17.5cm/7"

Gum, Fine, Eye Scissors ● EN
 Gum, Fein, Augen Scheren ● DE
 Goma de mascar, fina, tijeras de ojos ● ES



Lister
 05-1838-18
 18 cm/7"



Universal
 05-1839-12
 12 cm/4¾"



Goldman-Fox
 Straight
 05-1840-13
 13 cm/5"



Goldman-Fox
 Curved
 05-1841-13
 13 cm/5"

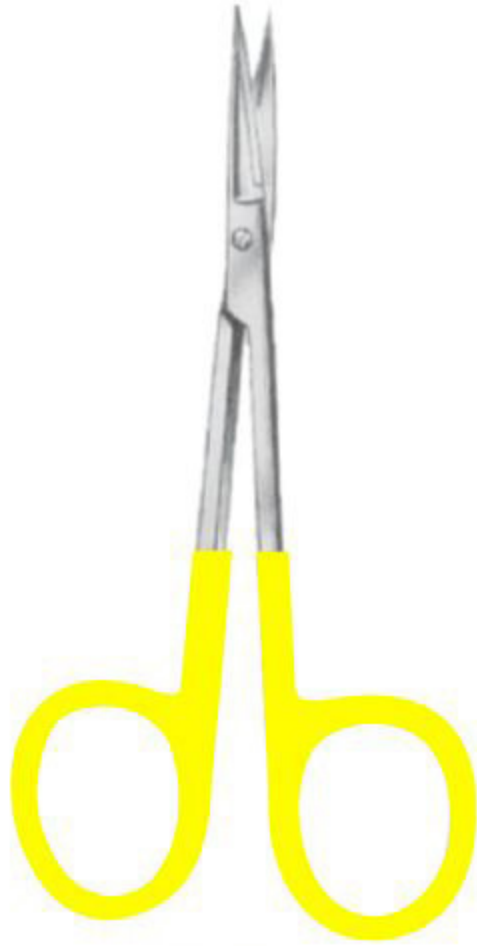

Straight
 05-1842-11



11.5cm/4½"

Curved
 05-1843-11



Straight
 05-1844-11

11.5cm/4½"



Curved
 05-1845-11

- EN** Forceps
- DE** Pinzetten
- ES** Pinzas

Page 95 to 111





Standard



Standard

06-1901-10	10.5cm
06-1901-11	11.5cm
06-1901-13	13.0cm
06-1901-14	14.5cm
06-1901-16	16.0cm
06-1901-18	18.0cm
06-1901-20	20.0cm
06-1901-23	23.0cm
06-1901-25	25.0cm
06-1901-30	30.0cm



Narrow

06-1902-10	10.5cm
06-1902-11	11.5cm
06-1902-13	13.0cm
06-1902-14	14.5cm
06-1902-16	16.0cm
06-1902-18	18.0cm
06-1902-20	20.0cm
06-1902-23	23.0cm
06-1902-25	25.0cm
06-1902-30	30.0cm



USA Model

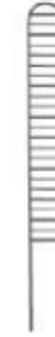

06-1903-12	12.0cm
06-1903-13	13.0cm
06-1903-14	14.5cm
06-1903-15	15.0cm
06-1903-18	18.0cm
06-1903-21	21.0cm
06-1903-25	25.0cm
06-1903-31	31.0cm



06-1904-12	12.0cm
06-1904-13	13.0cm
06-1904-14	14.5cm
06-1904-15	15.0cm
06-1904-18	18.0cm
06-1904-21	21.0cm
06-1904-25	25.0cm



Stille
 06-1905-15
 15.0cm

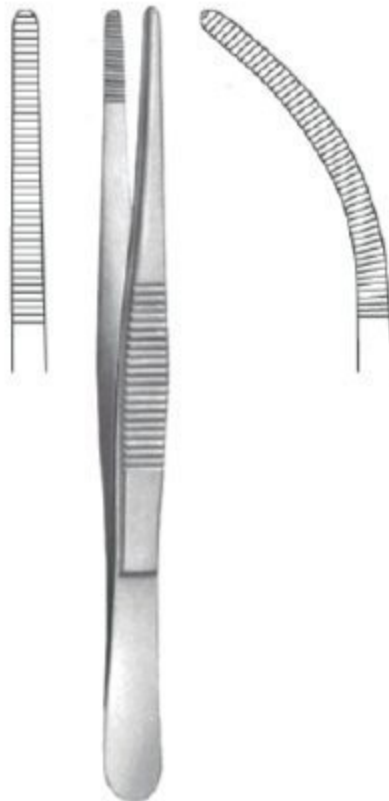

Ochsner
 06-1906-14
 14.0cm



Treves
 Turn over
 06-1907-12 12.0cm
 06-1907-15 15.0cm
 06-1907-18 18.0cm
 06-1907-20 20.0cm
 06-1907-25 25.0cm

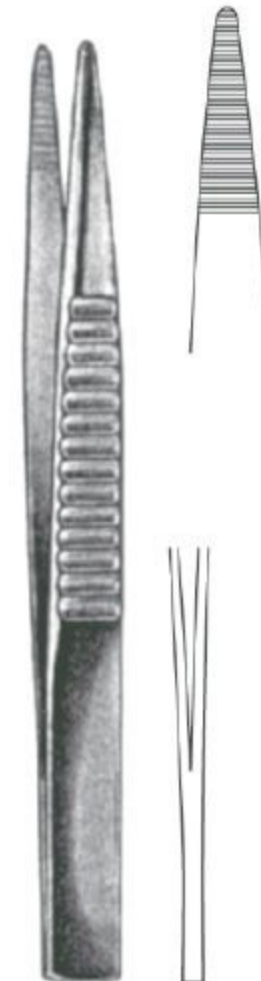

Treves
 Block end
 06-1908-12 12.0cm
 06-1908-15 15.0cm
 06-1908-18 18.0cm
 06-1908-20 20.0cm
 06-1908-25 25.0cm

Dressing Forceps ● EN
 Anatomische Pinzetten ● DE
 Pinzas de diseccion ● ES



Cushing
 06-1909-17 17.0cm 06-1910-17



Potts Smith
 06-1911-18 18.0cm
 06-1911-21 21.0cm
 06-1911-25 25.0cm
 06-1911-30 30.0cm



Waugh
 06-1912-15 15.0cm
 06-1912-18 18.0cm
 06-1912-20 20.0cm



Brophy
 06-1913-20 20.0cm 06-1914-20

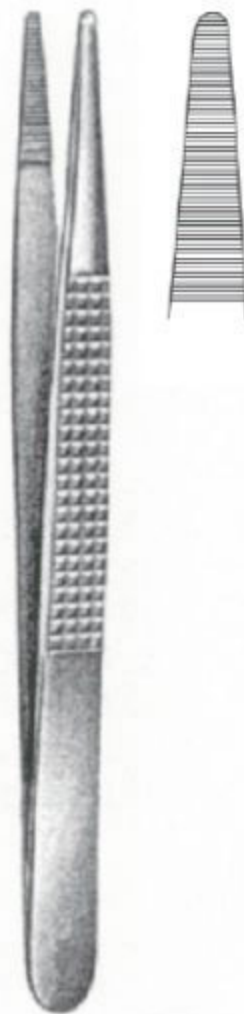

Bonney
 06-1915-17
 17.5cm



Ramsey
 06-1916-18
 18.0cm

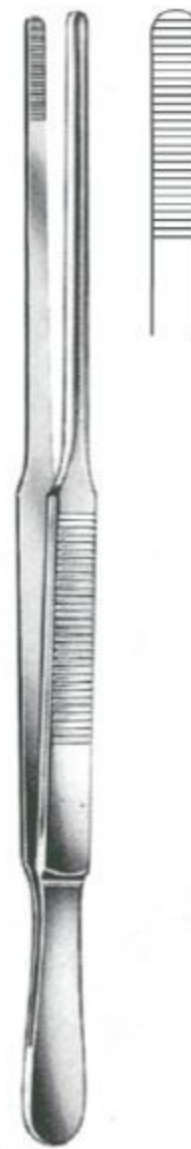

Duehrssen
 06-1917-20
 20.0cm



Wangenstein
 06-1918-23
 23.0cm



Adson
 06-1919-12 12.0cm
 06-1919-15 15.0cm
 06-1919-19 19.0cm



McIndoe
 06-1920-15 15.0cm



Semken
 06-1921-12 12.0cm 06-1922-12
 06-1921-15 15.0cm 06-1922-15



Gerald
 06-1923-18 18.0cm



Gerald
 06-1924-18 18.0cm



Gerald
 06-1925-18 18.0cm



Taylor
 06-1926-17 17.5cm Str
 06-1927-17 17.5cm Cvd



Taylor
 06-1928-17
 18.5cm



Taylor
 06-1929-17
 17.5cm



Jefferson
 06-1930-18
 18.0cm, 180mm



Adson
 06-1931-18
 18.0cm, 180mm

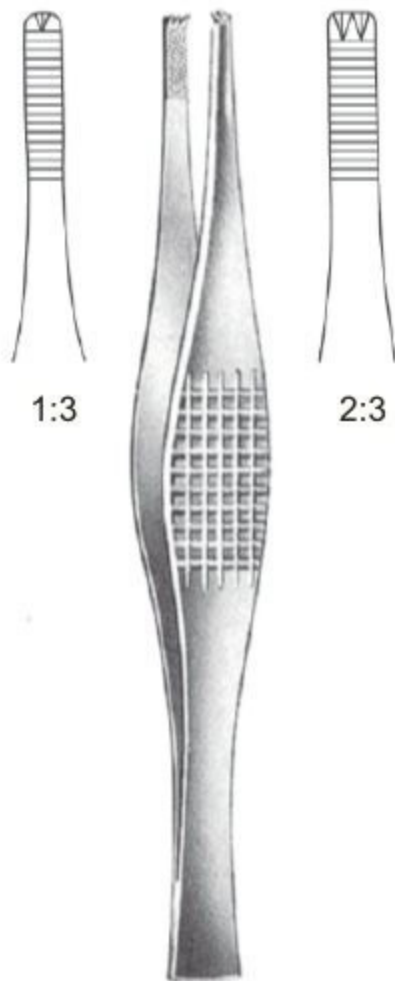

Ferris-Smith
 06-1932-18 18.0cm 06-1933-18



Ramsay
 18.0cm

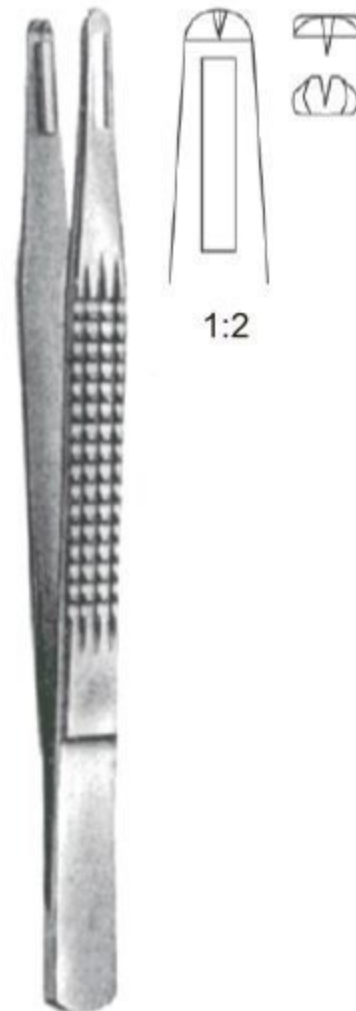

Charnley
 06-1936-18 18.0cm



Jeans
 06-1937-14 14.5cm
 06-1937-17 17.5cm



Standard

	Slender 1:2	Delicate 1:2	Regular 1:2	2:3	3:4	4:5
10.0cm			06-1940-10	06-1941-10	06-1942-10	06-1943-10
11.0cm	06-1938-11		06-1940-11	06-1941-11	06-1942-11	06-1943-11
13.0cm	06-1938-13	06-1939-13	06-1940-13	06-1941-13	06-1942-13	06-1943-13
14.0cm	06-1938-14	06-1939-14	06-1940-14	06-1941-14	06-1942-14	06-1943-14
16.0cm	06-1938-16	06-1939-16	06-1940-16	06-1941-16	06-1942-16	06-1943-16
18.0cm	06-1938-18	06-1939-18	06-1940-18	06-1941-18	06-1942-18	06-1943-18
20.0cm	06-1938-20	06-1939-20	06-1940-20	06-1941-20	06-1942-20	06-1943-20
23.0cm			06-1940-23			
25.0cm			06-1940-25	06-1941-25	06-1942-25	06-1943-25
30.0cm			06-1940-30	06-1941-30	06-1942-30	06-1943-30



USA Model

12.0cm	06-1944-12			
13.0cm	06-1944-13	06-1945-13	06-1946-13	06-1947-13
14.0cm	06-1944-14	06-1945-14	06-1946-14	06-1947-14
15.0cm	06-1944-15	06-1945-15	06-1946-15	06-1947-15
18.0cm	06-1944-18			
21.0cm	06-1944-21			
25.0cm	06-1944-25			
31.0cm	06-1944-31			

Tissue Forceps ●— EN
 Chirurgische Pinzetten ●— DE
 Pinzas de diseccion con dientes ●— ES

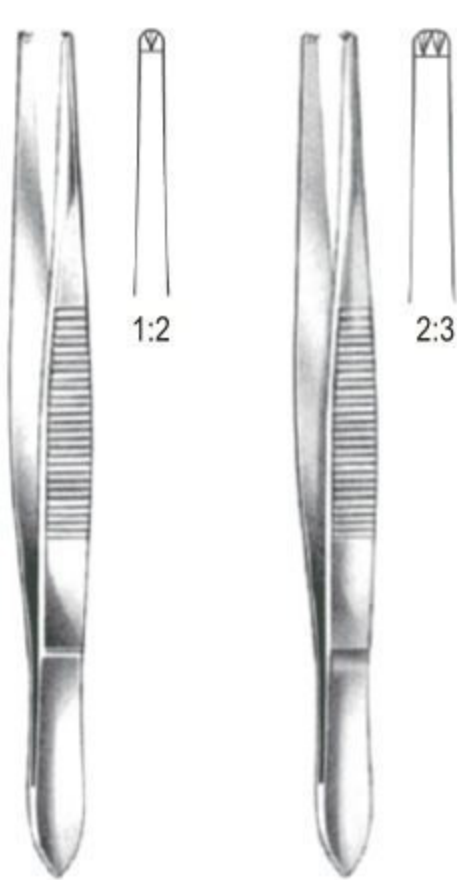

Stille
 06-1948-15 15.0cm
 06-1948-15 15.0cm



Treves
 06-1949-12 12.5cm
 06-1949-15 15.0cm
 06-1949-18 18.0cm
 06-1949-20 20.0cm
 06-1949-25 25.0cm

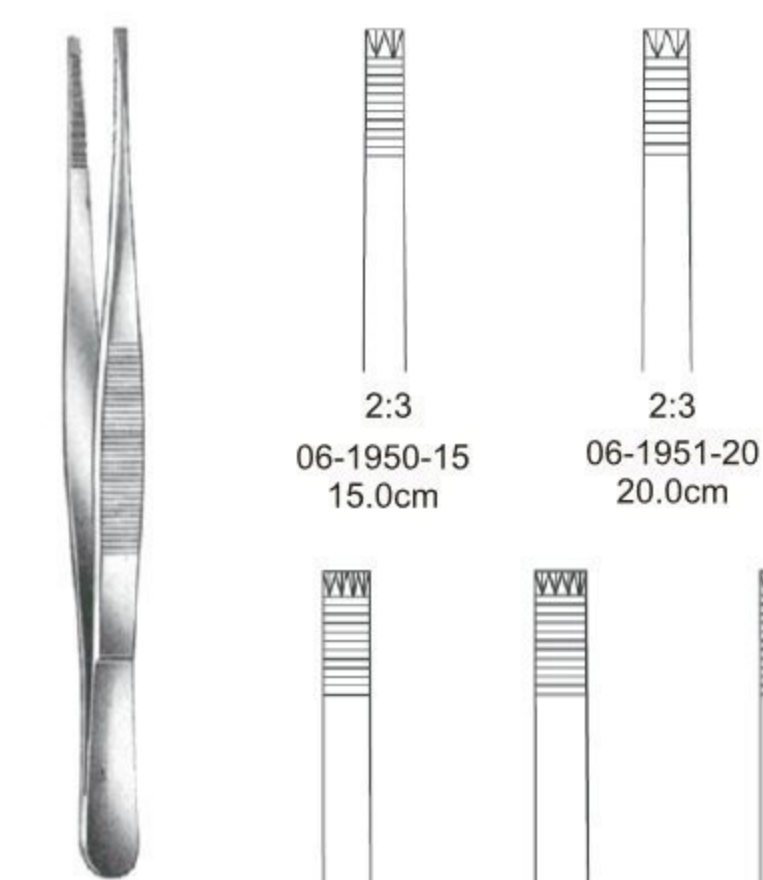

Adlerkreutz
 06-1950-15 15.0cm
 06-1951-20 20.0cm
 06-1952-15 15.0cm
 06-1953-20 20.0cm
 06-1954-25 25.0cm

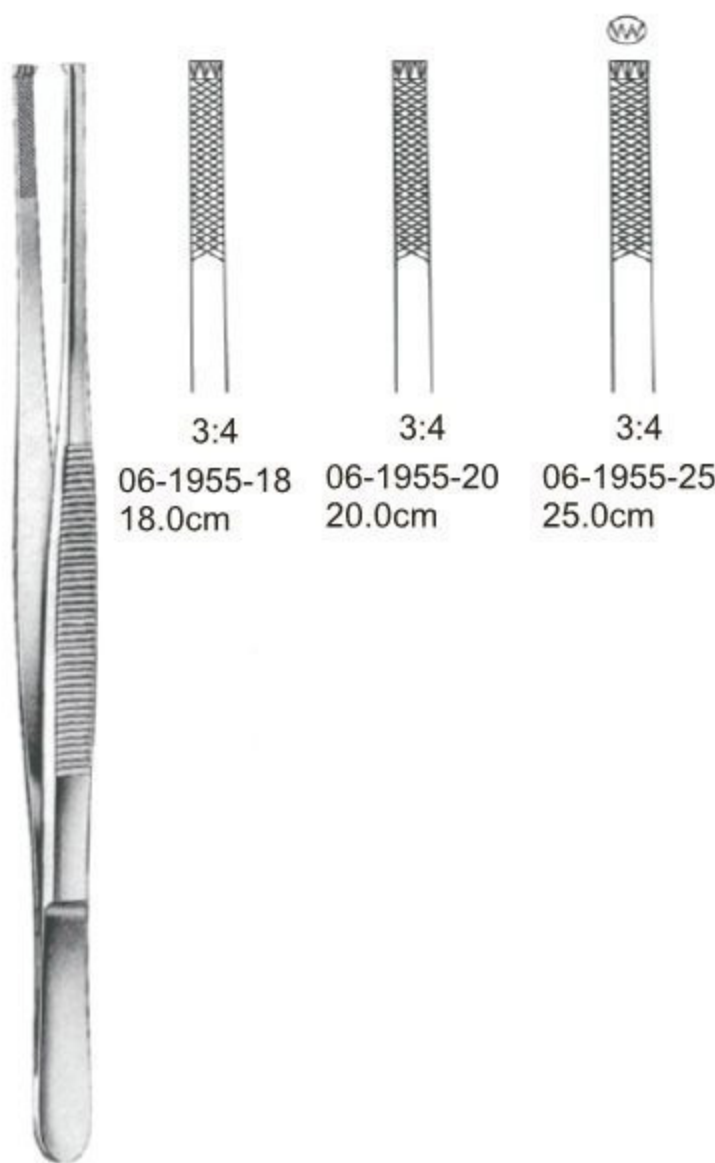

Stille-Barraya

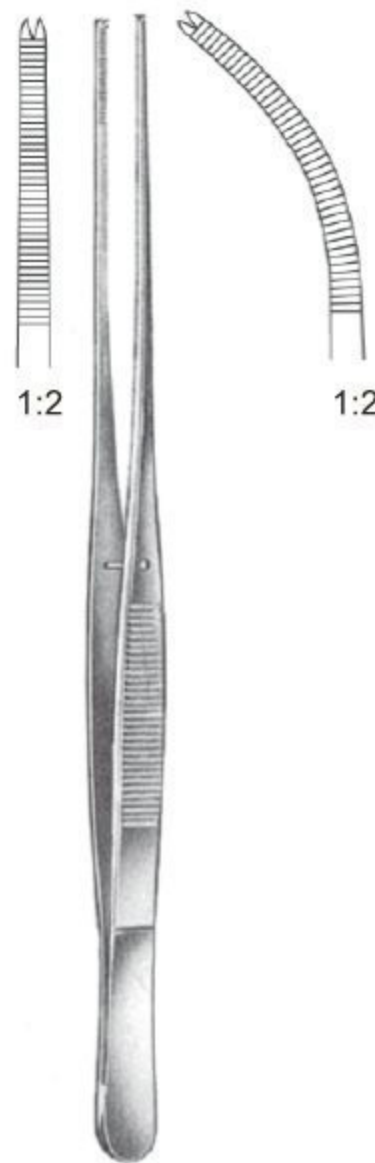

Brophy
 06-1956-20 20.0cm 06-1957-20

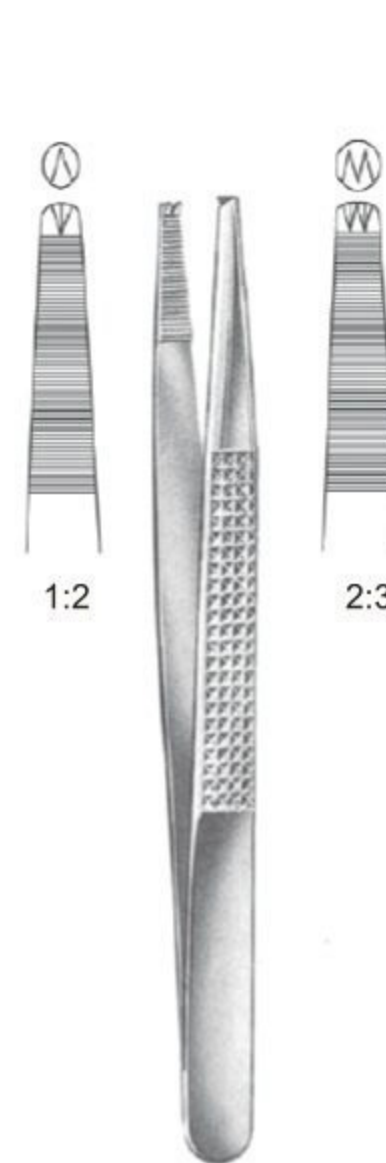

Bonney
 06-1958-18 18.0cm 06-1959-18



Adson
 06-1960-18 18.0cm

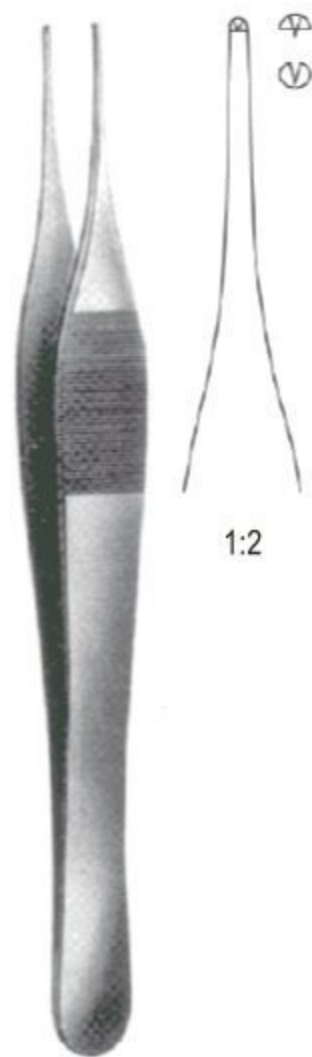

Jefferson
 06-1961-18 18.0cm

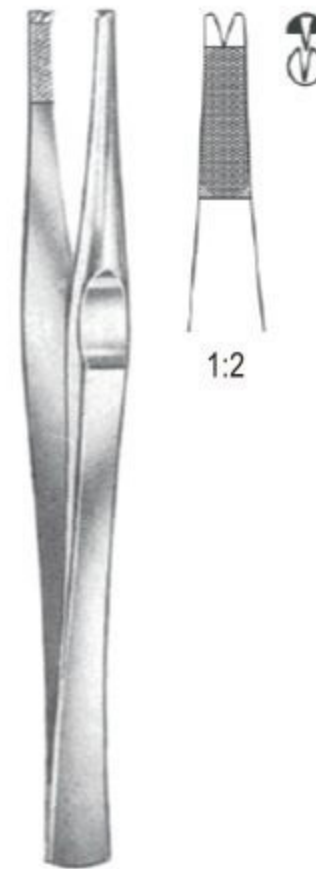

Lanes
 06-1962-12 12.5cm
 06-1962-15 15.0cm
 06-1962-18 18.0cm
 06-1962-20 20.0cm

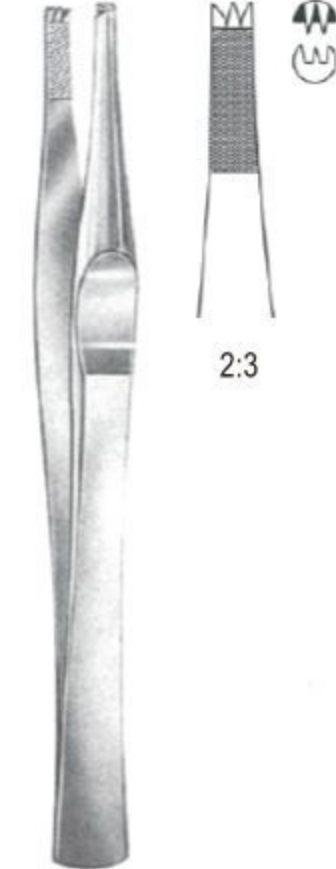

Lanes
 06-1963-12 12.5cm
 06-1963-15 15.5cm
 06-1963-18 18.0cm
 06-1963-20 20.0cm

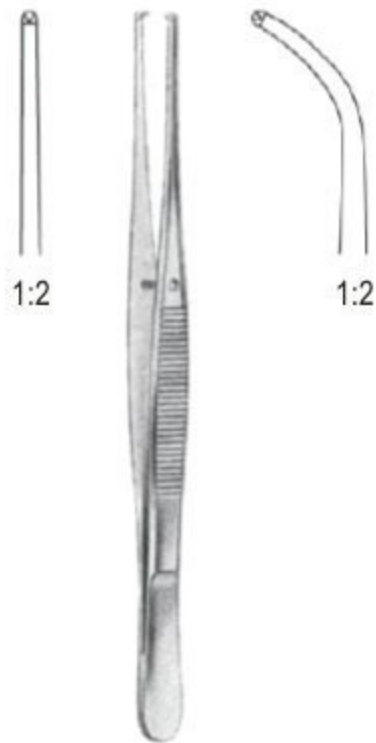

Semken
 06-1964-12 12.5cm 06-1965-12 12.5cm
 06-1964-15 15.0cm 06-1965-15 15.0cm

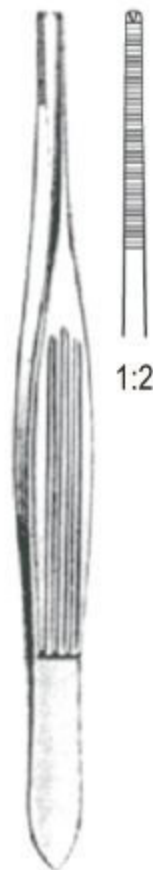

McIndoe

06-1966-15 15.0cm 06-1967-15 15.0cm



Gillies

06-1967-15 15.0cm

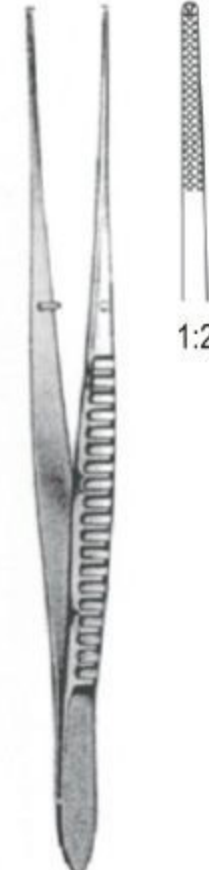

Waugh

06-1968-15 15.0cm
 06-1968-18 18.0cm
 06-1968-20 20.0cm



Potts Smith

06-1969-18 18.0cm
 06-1969-21 21.0cm
 06-1969-25 25.0cm
 06-1969-30 30.0cm

Tissue Forceps ● EN
 Chirurgische Pinzetten ● DE
 Pinzas de diseccion con dientes ● ES

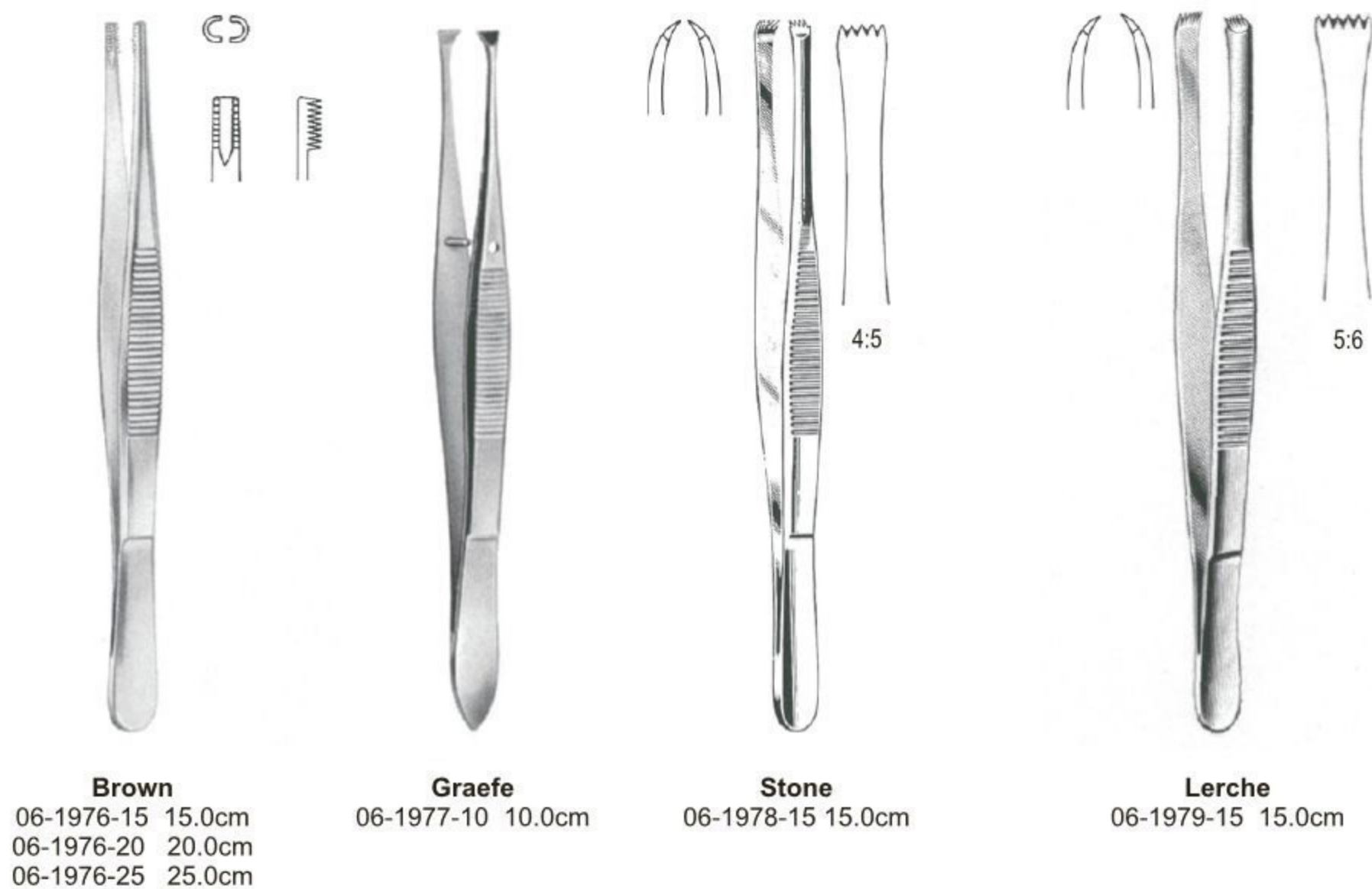
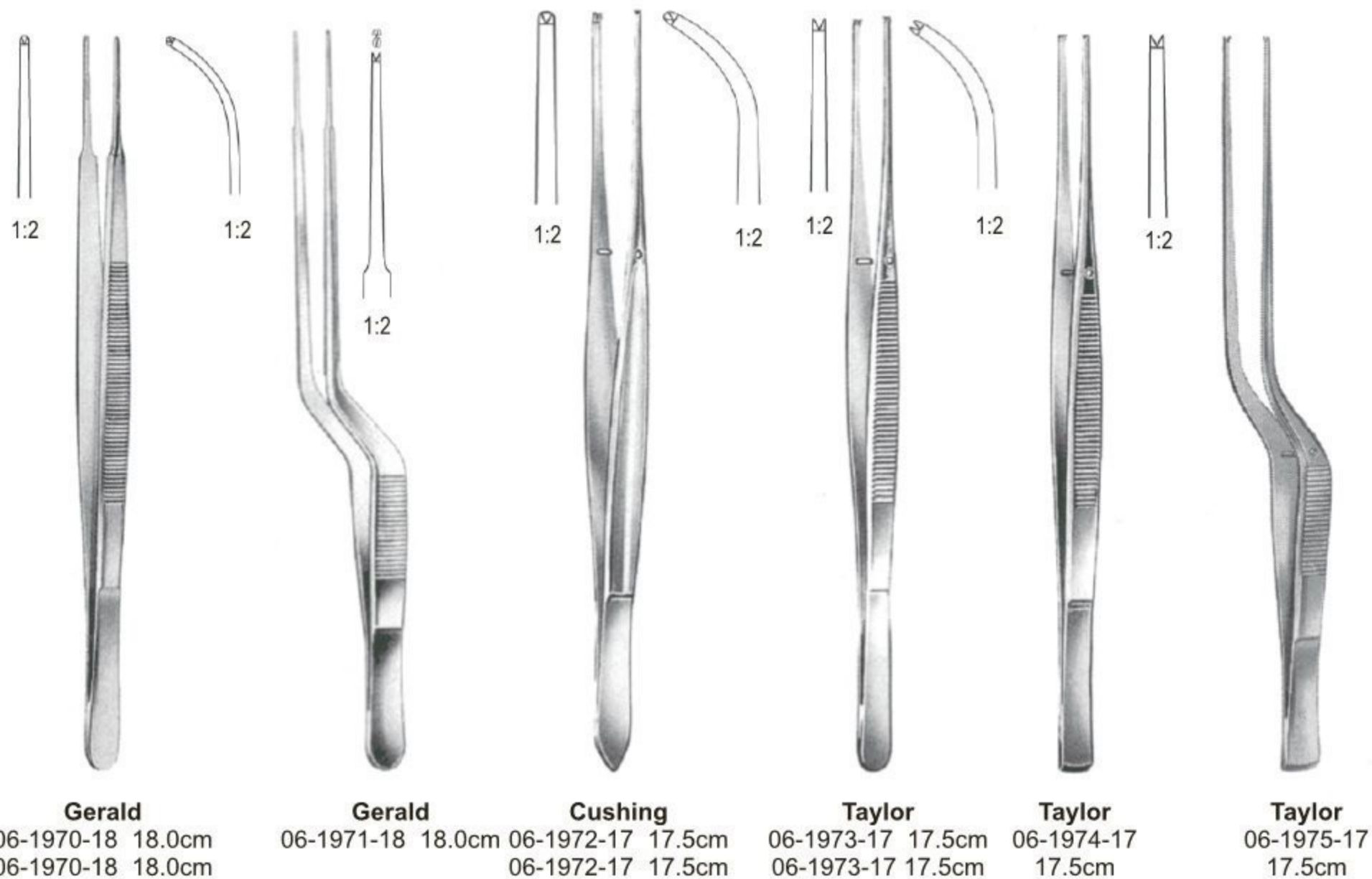

- EN —● Tissue, Tumor Forceps
- DE —● Chirurgische, Fasspinzetten
- ES —● Pinzas, para coger diseccion con dientes

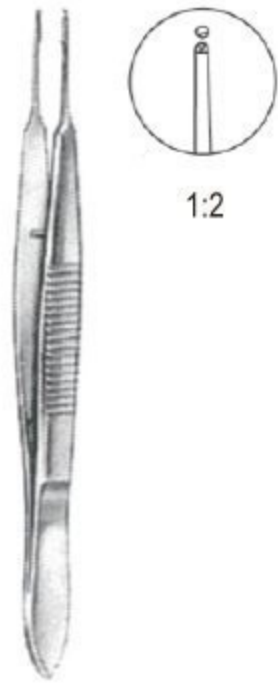

06-1980-11
11.0cm

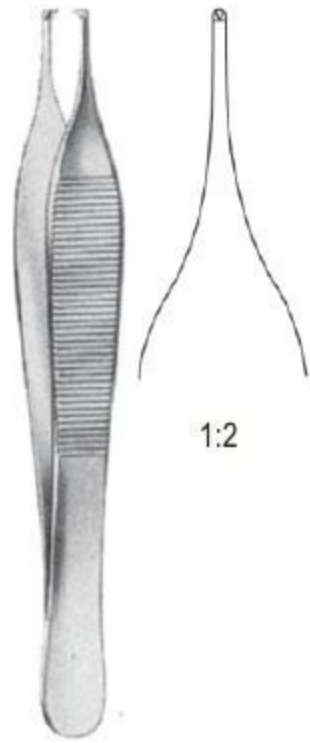

Adson
 06-1981-12 12.0cm
 06-1981-15 15.0cm

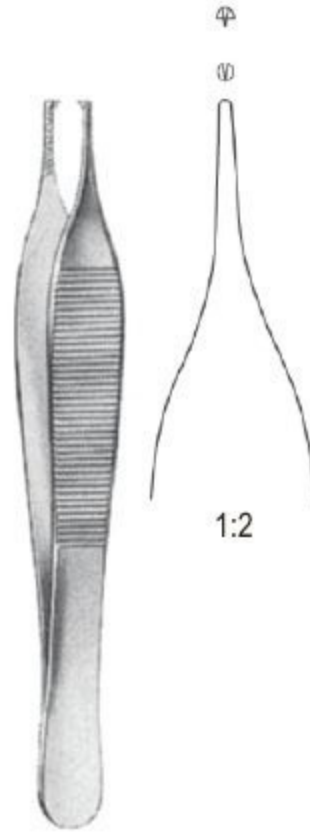

Adson
 06-1982-12 12.0cm

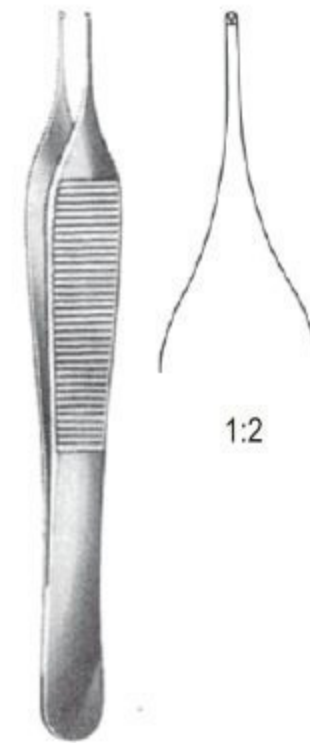

Micro-Adson
 06-1983-12 12.0cm



Adson-Brown
 06-1984-12 12.0cm



Durante

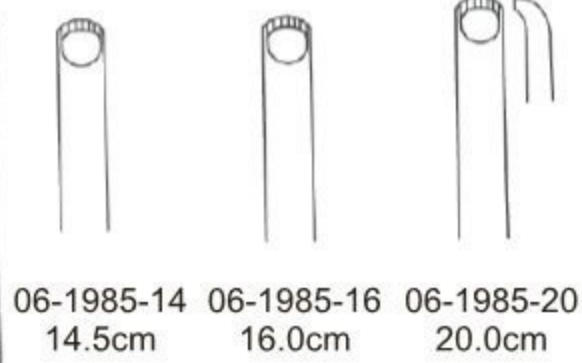

Russ Modell

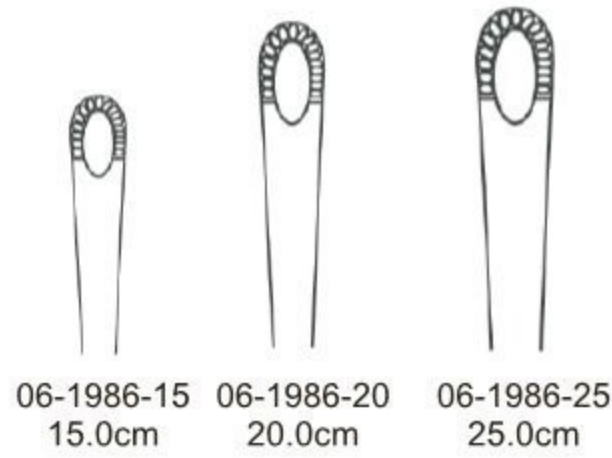

Mayo Russ
 06-1987-23 23.0cm

Tissue, Tumor Forceps ●— EN
 Chirurgische, Fasspinzetten ●— DE
 Pinzas, para coger diseccion con dientes ●— ES



Micro Adson
 06-1988-12 12.0cm



06-1989-12 12.0cm 06-1990-12 12.0cm
 06-1989-16 16.0cm 06-1990-16 16.0cm



10 cm
 11.5cm



06-1991-01
 06-1991A-01



06-1991-02
 06-1991A-02



06-1991-03
 06-1991A-03



1:2
 06-1992-01
 06-1992A-01



1:2
 06-1992-02
 06-1992A-02



1:2
 06-1992-03
 06-1992A-03



Yasargil
 22.0cm



06-1993-03 3mm Ø
 06-1993-05 5mm Ø



Yasargil
 22.0cm



06-1994-03 3mm Ø
 06-1994-05 5mm Ø



Heifetz
 22.0cm



06-1995-03 3mm Ø
 06-1995-05 5mm Ø



- EN —● Tissue and Micro Forceps, Fine Pattern
- DE —● Chirurgische und Mikro-Pinzetten, feine modelle
- ES —● De diseccion con dientes micro-pinzas, modelos finos

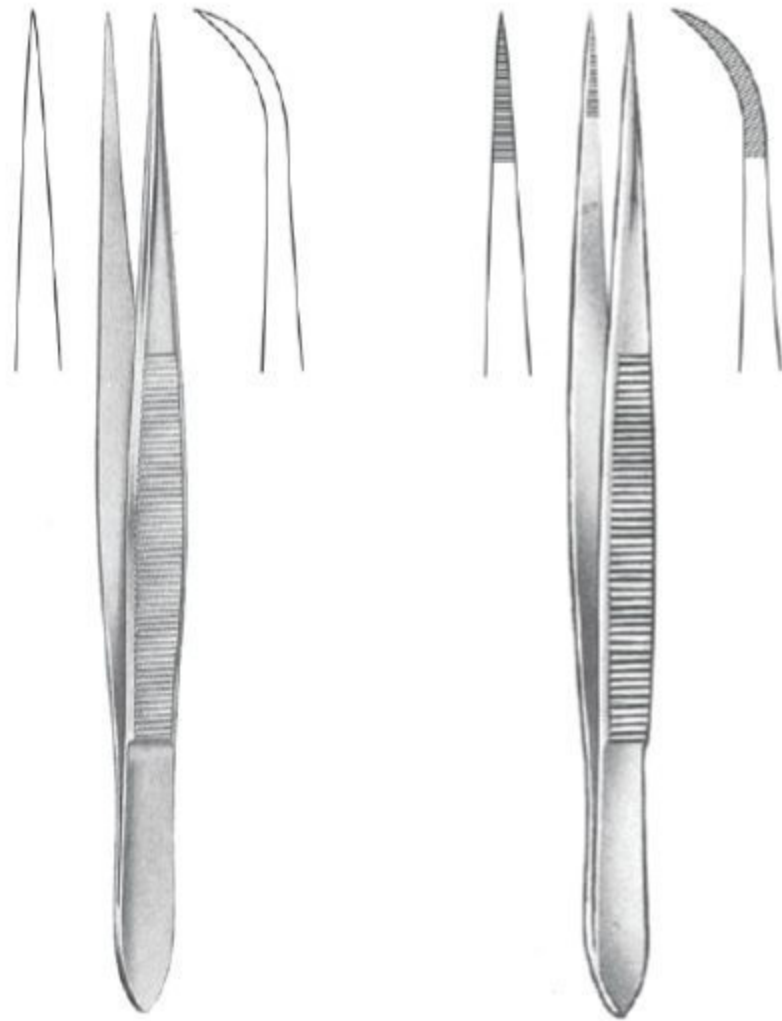

06-1996-09	09.0cm	06-1997-09	06-1998-09	09.0cm	06-1999-09
06-1996-10	10.5cm	06-1997-10	06-1998-10	10.5cm	06-1999-10
06-1996-11	11.5cm	06-1997-11	06-1998-11	11.5cm	06-1999-11
06-1996-12	12.0cm	06-1997-12	06-1998-12	12.0cm	06-1999-12

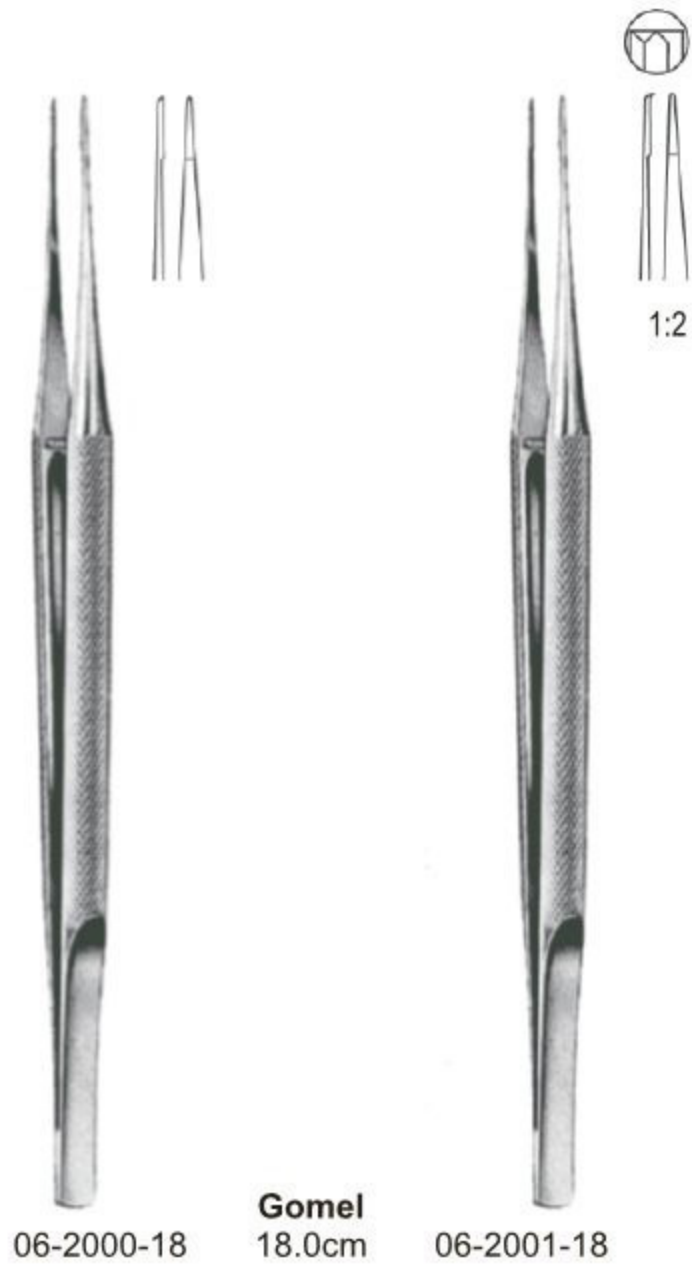

06-2000-18 Gomel 18.0cm 06-2001-18

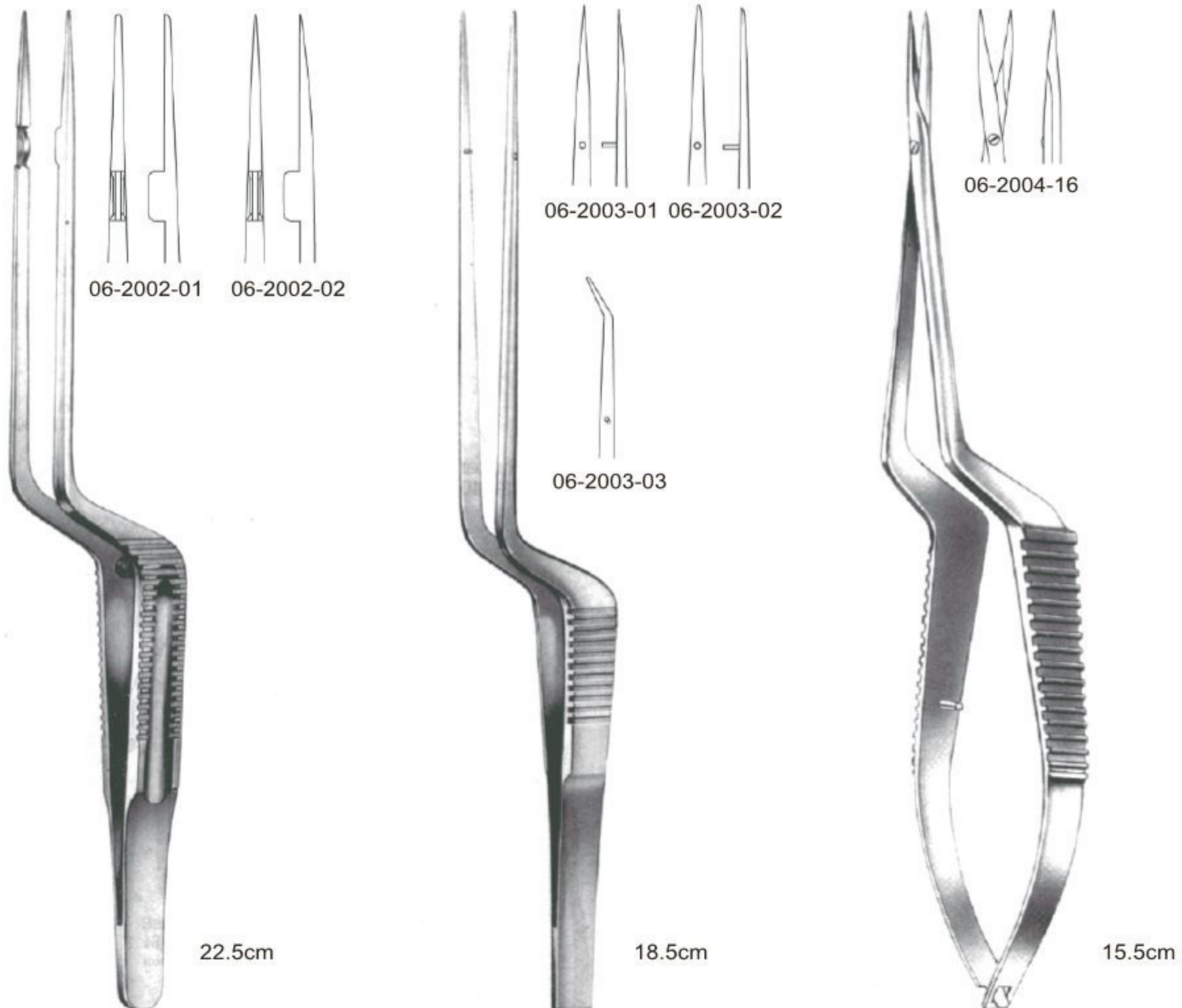

06-2002-01 06-2002-02

06-2003-01 06-2003-02

06-2004-16

06-2003-03

22.5cm

18.5cm

15.5cm

- Splinter Forceps ●— EN
- Spitter-Pinzetten ●— DE
- Pinzas para espinas ●— ES



06-2005-12
12.0cm



Feilchenfeld



06-2006-07
7.5cm



06-2006-09
9.0cm



06-2006-20
11.5cm



06-2007-12
12.5cm



06-2008-10



Hunter
10.5cm



06-2009-10



06-2010-10



Walter-Carmalt
10.5cm



06-2011-10

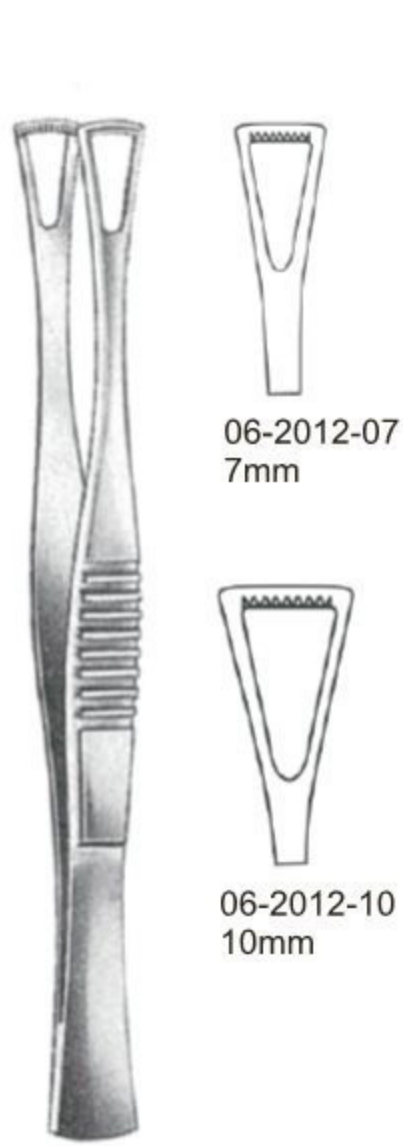

Duval
14.5cm

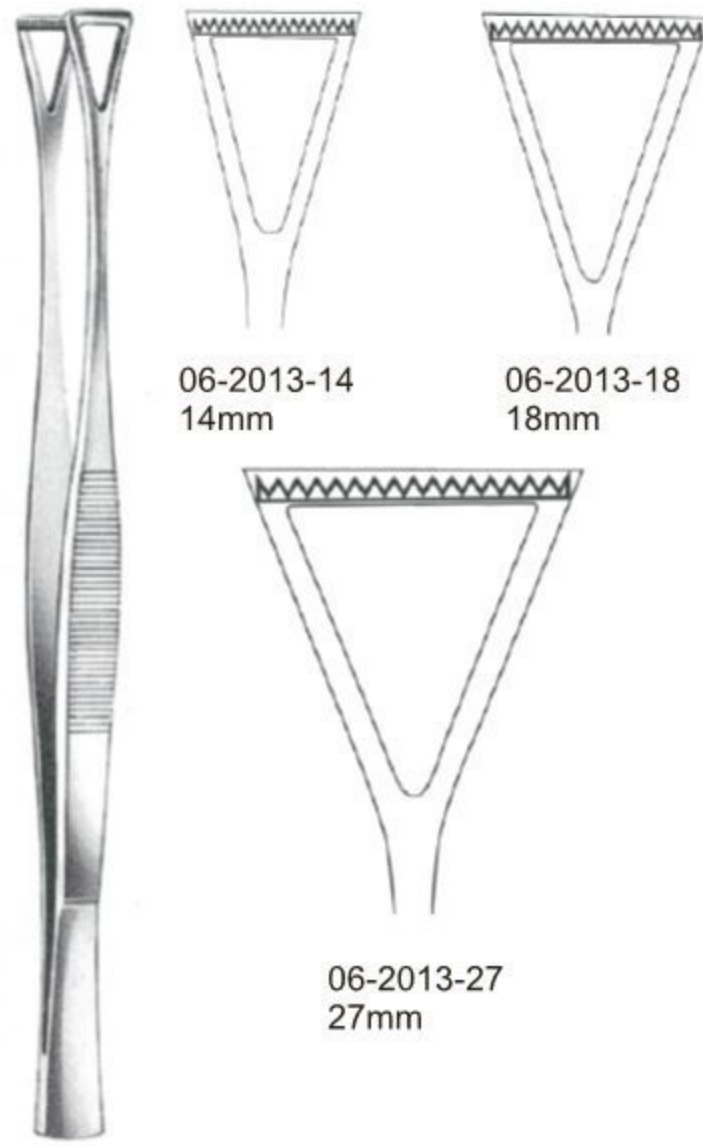

Collin-Duval
20.0cm

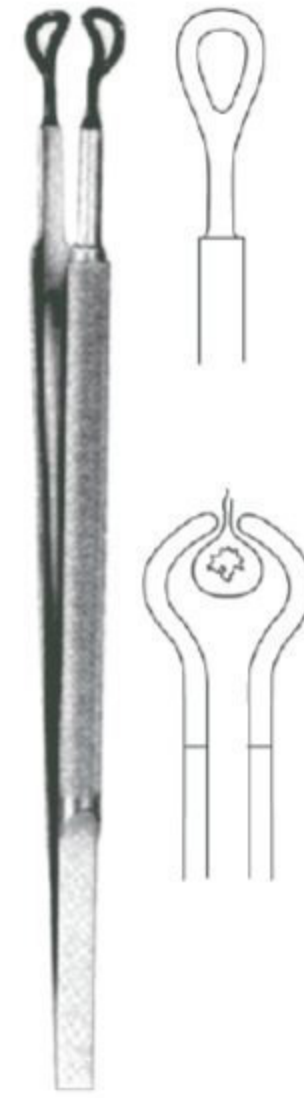

Hepp/Scheidel
06-2014-18 18.0cm



Singley-Tuttle
06-2015-23 23.0cm



Nelson
06-2016-23 23.0cm



06-2017-21
21.0cm

Cilia Forceps ● EN
 Cillenpinzetten ● DE
 Pinzas depilatorias ● ES



Beer
 06-2018-09 9.0cm



Littauer
 06-2019-08 8.5cm



06-2020-09 9.0cm



Douglas
 06-2021-09 9.0cm



Douglas
 06-2022-09 9.0cm



Barraquer
 06-2023-10 10.5cm



Gradle
 06-2024-09 9.5cm



Henry
 06-2025-12 12.0cm



Peet
 06-2026-11 11.5cm

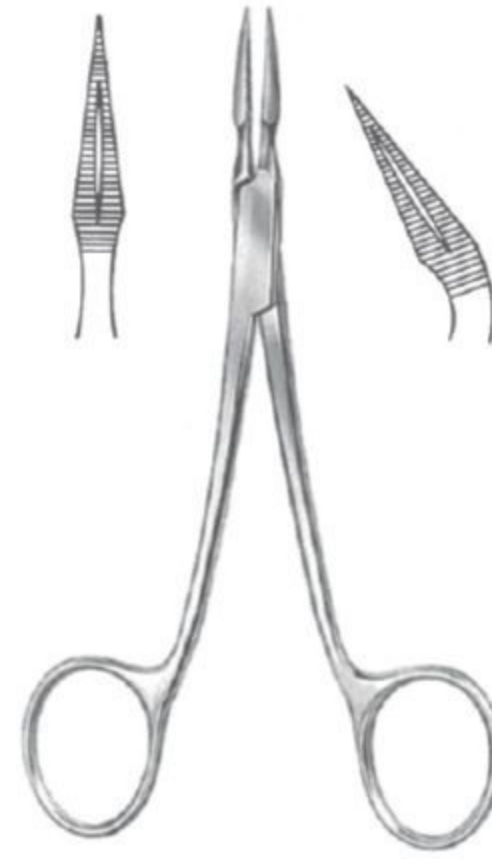

Arther
 06-2027-14 14.0cm 12.0401.14

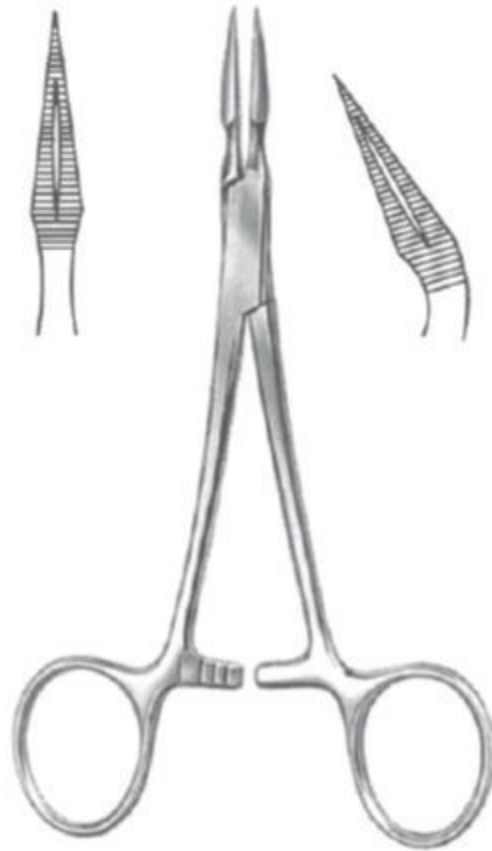

Stieglitz
 06-2028-13 13.5cm 06-2029-13

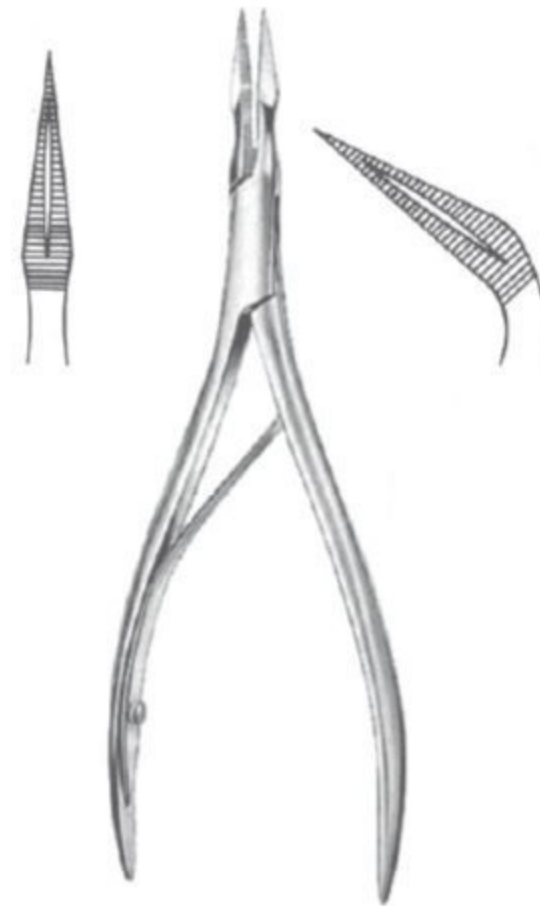

Ralk
 06-2030-15 15.0cm 06-2031-15

Dressing Forceps ● EN
 Anatomische Pinzetten ● DE
 Pinzas de diseccion ● ES

**Standard**

06-2032-14 14.5cm/5 ¾"
 06-2032-16 16cm/6 ¼"
 06-2032-18 18cm/7"
 06-2032-20 20cm/8"
 06-2032-25 25cm/10"

**Adson**

06-2033-12 12cm/4 ¾"
 06-2033-15 15.5cm/6"

**McIndoe**

06-2034-15
 15cm/6"

**Semken**

06-2035-12 12cm/4 ¾"
 06-2035-15 15cm/6"



06-2036-18
 18cm/7"

**Cushing**

06-2037-18
 18cm/7"

**Cushing-Taylor**

06-2038-18
 18cm/7"

**Grunwald**

06-2039-18
 18cm/7"



Wangensteen
 06-2040-15 15cm/6"
 06-2040-23 13cm/9"
 06-2040-25 25cm/10"



06-2041-15 15cm/6"
 06-2041-18 18cm/7"
 06-2041-20 20cm/8"
 06-2041-23 23cm/9"
 06-2041-25 25cm/10"



Oehler
 1:2
 06-2042-14 14.5cm/5 1/2"
 06-2042-16 16cm/6 1/4"
 06-2042-18 18cm/7"
 06-2042-20 20cm/8"
 06-2042-25 25cm/10"
 06-2042-30 30cm/12"



Micro-Adson
 06-2043-12 12cm/4 3/4"
 06-2043-15 15.5cm/6"



Standard-Adson
 06-2044-12 12cm/4 3/4"
 06-2044-15 15.5cm/6"



Adson-Brown
 06-2045-12
 12cm/4 3/4"



Gillies
 06-2046-15
 15 cm/6"

- EN** Artery Forceps
- DE** Arterienklemmen
- ES** Pinzas hemostáticas

Page 112 to 140





Terrier
 07-2101-10
 10 cm/4"



Pennington
 07-2102-15 15 cm/6"
 07-2102-20 20 cm/8"



Peau
 07-2103-12
 12.5 cm/5"

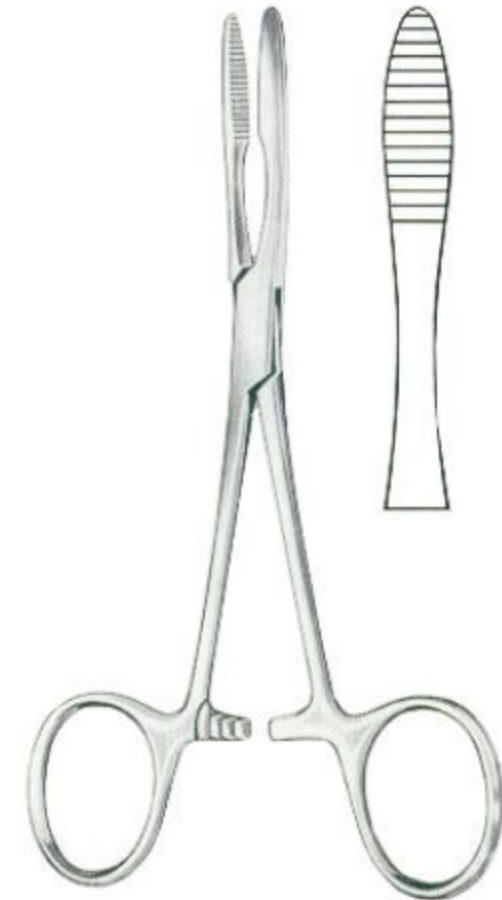

Peau
 07-2104-14 14 cm/5 3/4"
 07-2104-16 16 cm/6 1/4"



Peau
 07-2105-14
 14 cm/5 1/2"



Collin
 07-2106-15
 15.5 cm/6"



Collin
 07-2107-14
 14 cm/5 1/2"



Collin
 07-2108-16
 16.5 cm/6 1/2"



Hartmann
 10 cm/4"



Halstead-Mosquito
 12 cm/4¾"
 14 cm/5½"

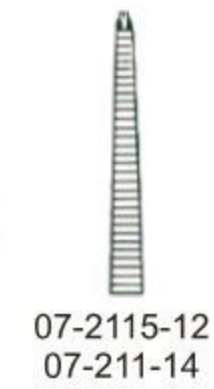

Micro-Mosquito
 10 cm/4"
 12 cm/4¾"

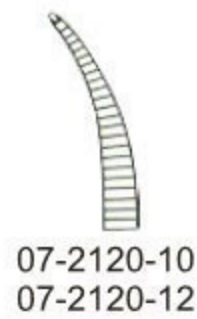
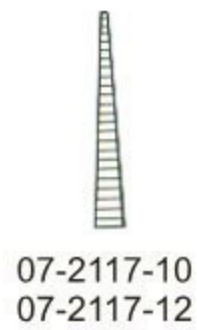

Jacobson-Halstead
 13 cm/5"

Very fine



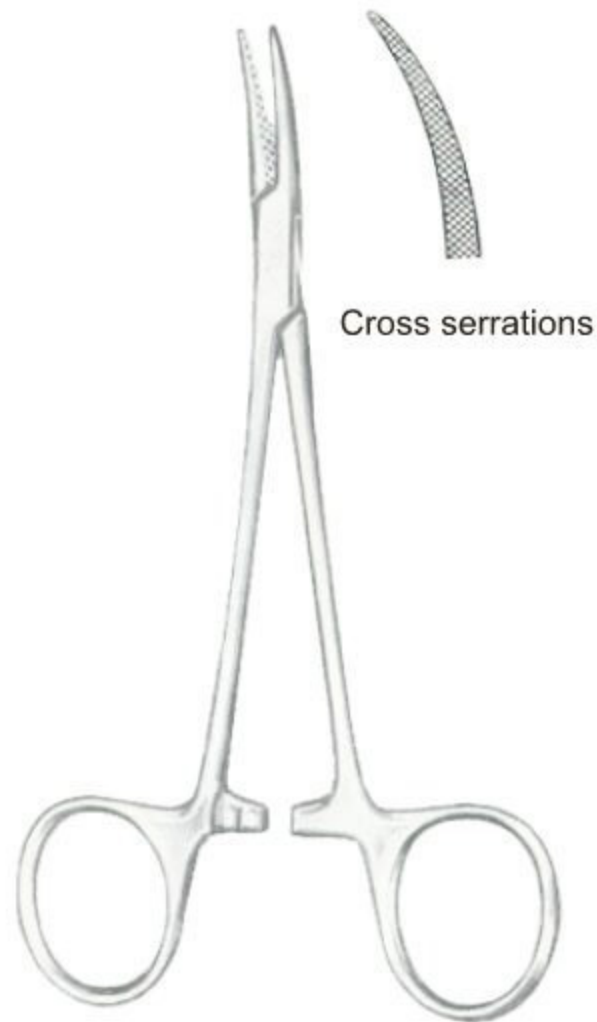

Cross serrations

07-2123-12
 12 cm/4¾"



Halstead-Mosquito
 18 cm/7"
 21 cm/8¼"



07-2124-18
 07-2124-21



07-2125-18
 07-2125-21



07-2126-18
 07-2126-21



07-2127-18
 07-2127-21



Kelly
 14 cm/5½"

Kelly-Rankin
 16 cm/6¼"



07-2128-14



14 cm/5½" 07-2129-14



07-2130-16



16 cm/6¼" 07-2131-16



Crile
 14 cm/5½"

Crile-Rankin
 16 cm/6¼"

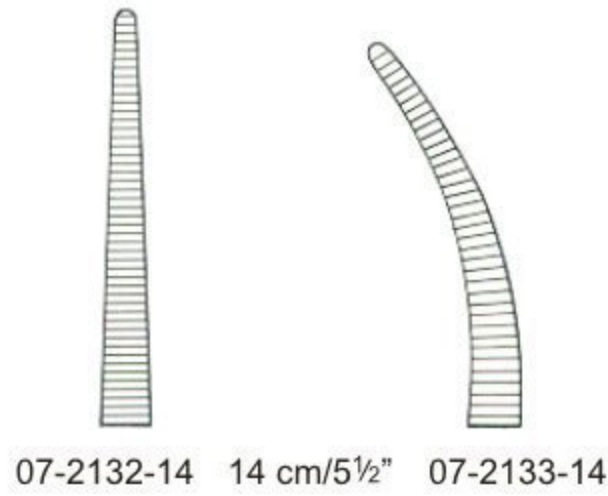

07-2132-14 14 cm/5½" 07-2133-14

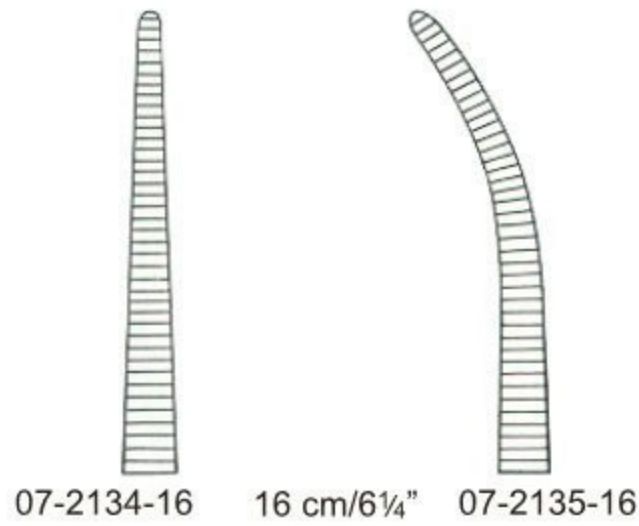

07-2134-16 16 cm/6¼" 07-2135-16



Baby-Crile
 14 cm/5½"

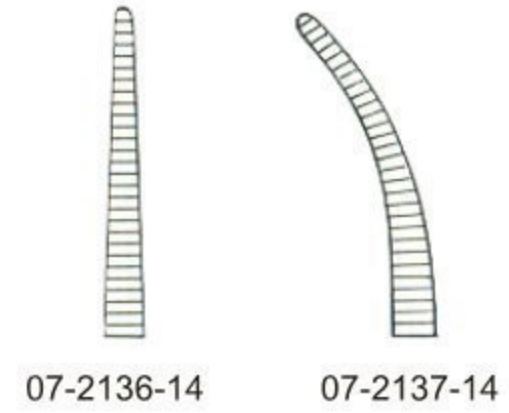

07-2136-14 07-2137-14



Crile
 14 cm/5½"

Crile-Rankin
 16 cm/6¼"

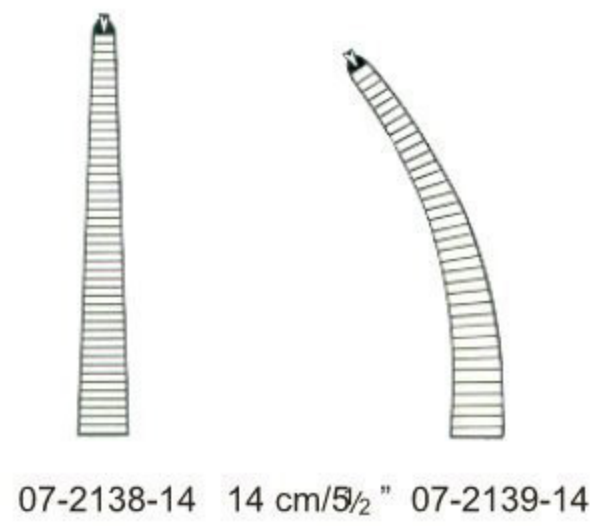

07-2138-14 14 cm/5½" 07-2139-14

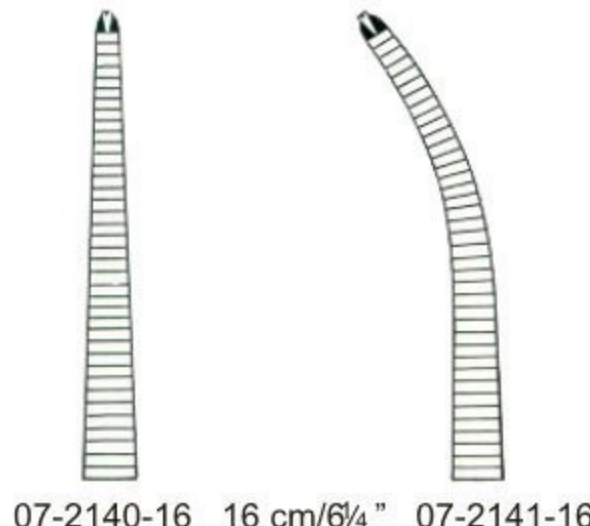

07-2140-16 16 cm/6¼" 07-2141-16



Baby-Crile
 14 cm/5½"

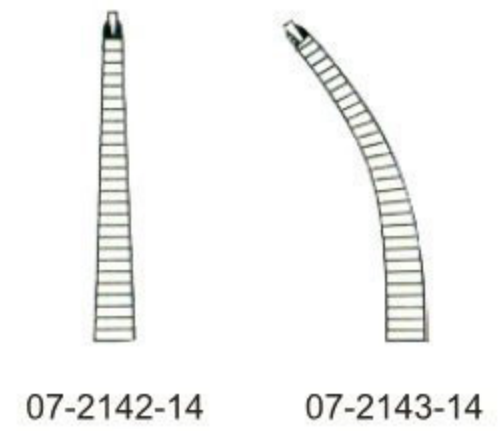

07-2142-14 07-2143-14



Coller-Crile

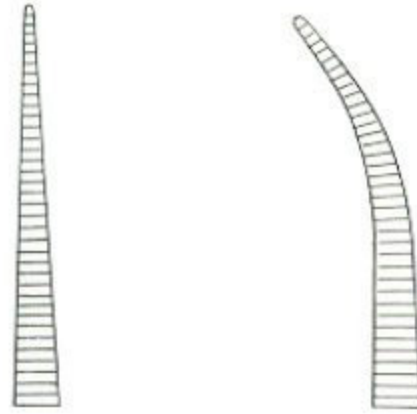

07-2144-14 14 cm/5 1/2" 07-2145-14

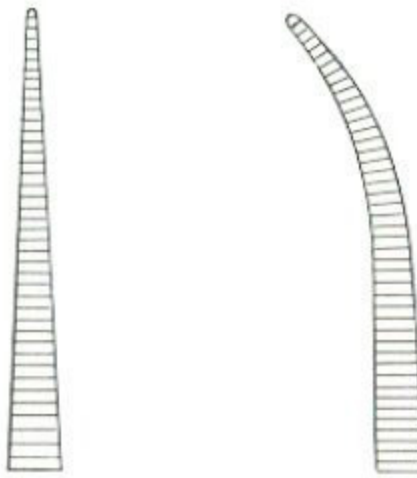

07-2146-16 16 cm/6 1/4" 07-2146-16



Coller-Crile
 07-2147-16
 16 cm/6 1/4"



Leriche
 15 cm/6"

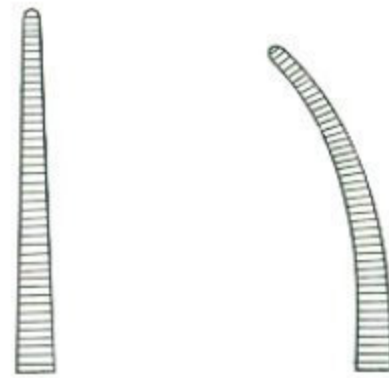

07-2148-15 07-2149-15

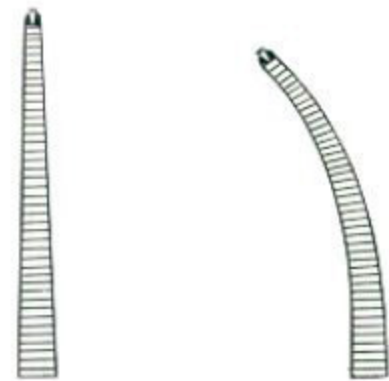

07-2150-15 07-2151-15



Providence
 14 cm/5 1/2"



07-2152-14



07-2153-14

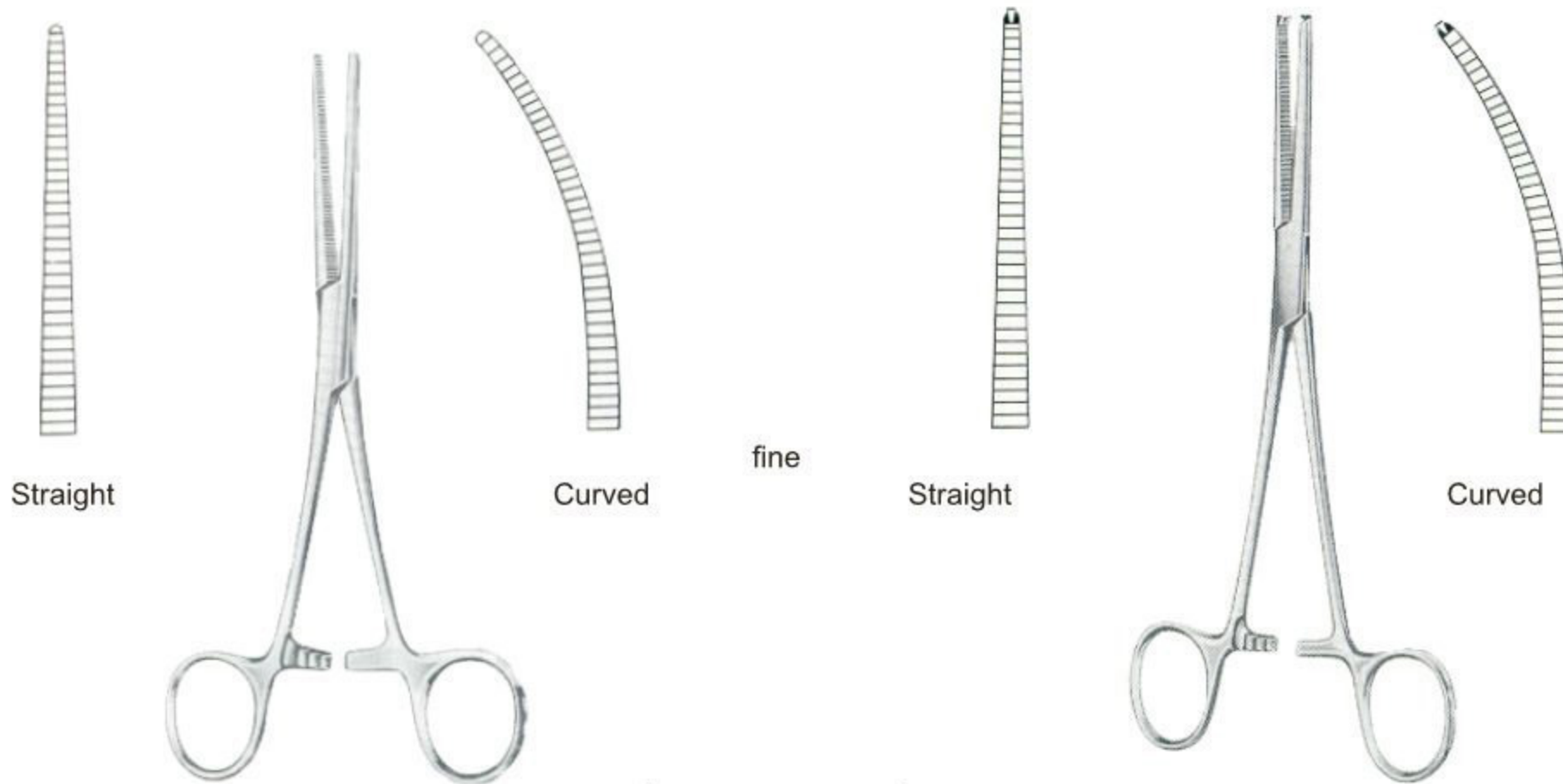

Rochester-Pean		cm	in	Ochsner-Kocher	
07-2154-13	07-2155-13	13.0	5"	07-2156-13	07-2157-13
07-2154-14	07-2155-14	14.0	5 1/2"	07-2156-14	07-2157-14
07-2154-16	07-2155-16	16.0	6 1/4"	07-2156-16	07-2157-16

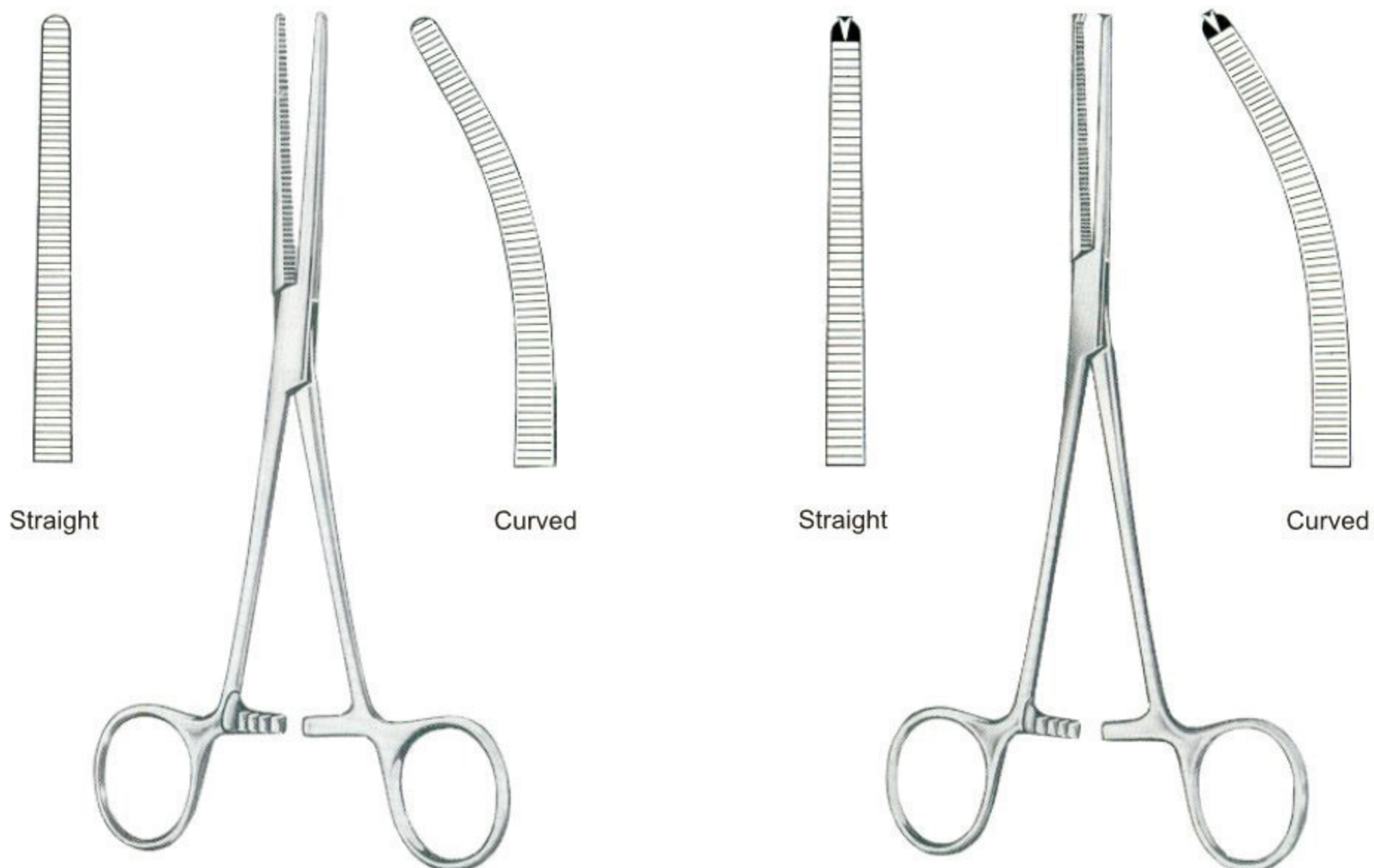

Rochester-Pean		cm	in	Ochsner-Kocher	
07-2158-13	07-2159-13	13.0	5"	07-2160-13	07-2161-13
07-2158-14	07-2159-14	14.0	5 1/2"	07-2160-14	07-2161-14
07-2158-16	07-2159-16	16.0	6 1/4"	07-2160-16	07-2161-16
07-2158-18	07-2159-18	18.0	7"	07-2160-18	07-2161-18
07-2158-20	07-2159-20	20.0	8"	07-2160-20	07-2161-20
07-2158-22	07-2159-22	22.0	8 3/4"	07-2160-22	07-2161-22
07-2158-24	07-2159-24	24.0	9 1/2"	07-2160-24	07-2161-24
07-2158-26	07-2159-26	26.0	10 1/4"	07-2160-26	07-2161-26
07-2158-30	07-2159-30	30.0	12"	07-2160-30	07-2161-30

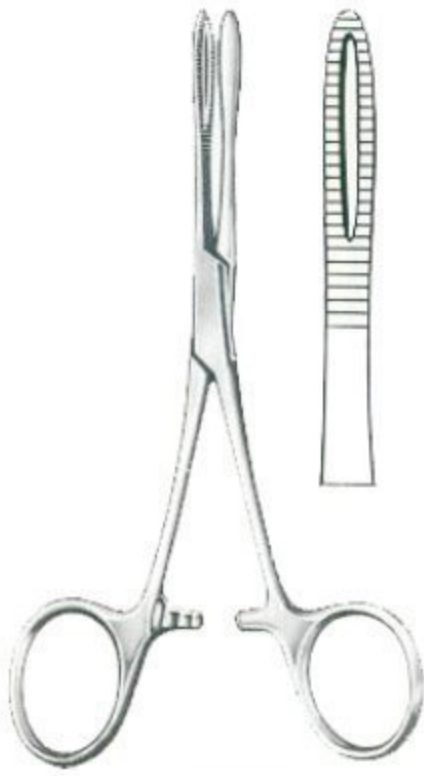
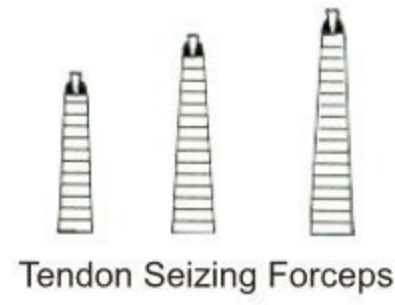

Kronlein
 07-2162-13
 13cm/5"



Brand
 07-2163-15 15cm/6"
 07-2163-19 19cm/7 1/2"
 07-2163-24 24cm/9 1/2"



Brand
 07-2164-15 15cm/6"
 07-2164-19 19cm/7 1/2"
 07-2164-24 24cm/9 1/2"

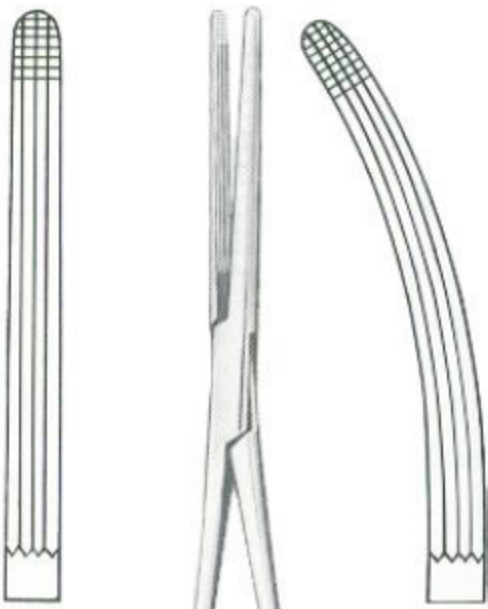

07-2165-16
 07-2165-20

07-2166-16
 07-2166-20



Rochester-Carmalt
 16cm/6 1/4"
 20cm/8"

Lateral Curved



07-2167-12



Mosquito-Dandy
 12cm/4 3/4"



07-2168-12

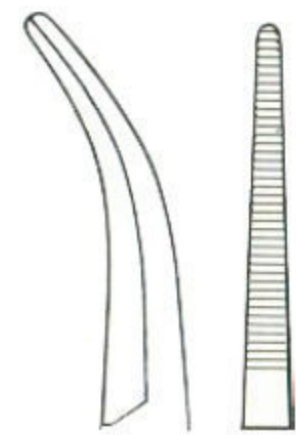

07-2169-14



Dandy
 14cm/5 1/2"

07-2170-14



Lovelace
 07-2171-15
 15.5cm/6"



Dixon-Lovelace
 07-2172-16
 16cm/6¼"



Dixon-Lovelace
 07-2173-16
 16cm/6¼"



Bainbridge
 15cm/6"
 18cm/7"



Fuchsig
 07-2176-19
 19cm/7½"





Adson
 18.5cm/7¼"

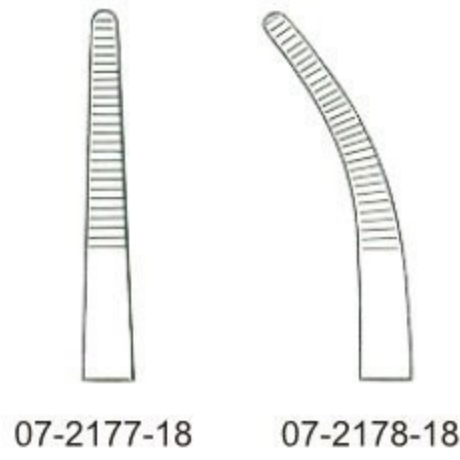

07-2177-18 07-2178-18

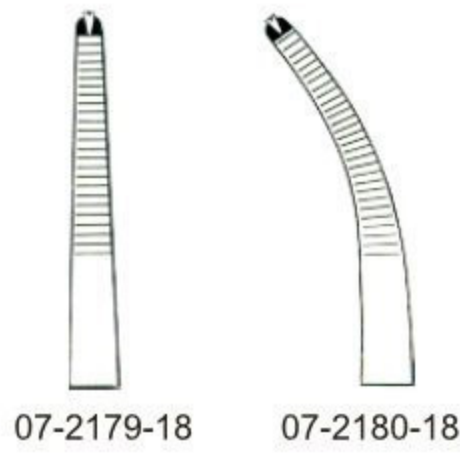

07-2179-18 07-2180-18



Nissen
 07-2181-18 18.5cm/7 ¼"
 07-2181-22 22.0cm/8 ¾"



Baby-Adson



07-2182-14
 14cm/5½"



07-2182-18
 18cm/7"

Very Fine

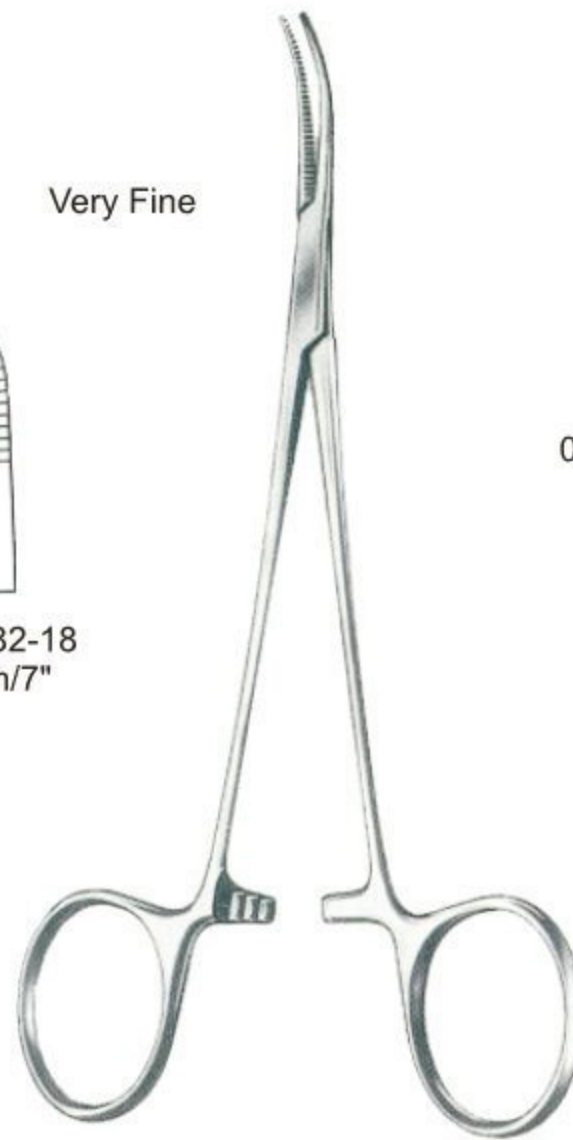

Jacobson-Adson
 18cm/7"

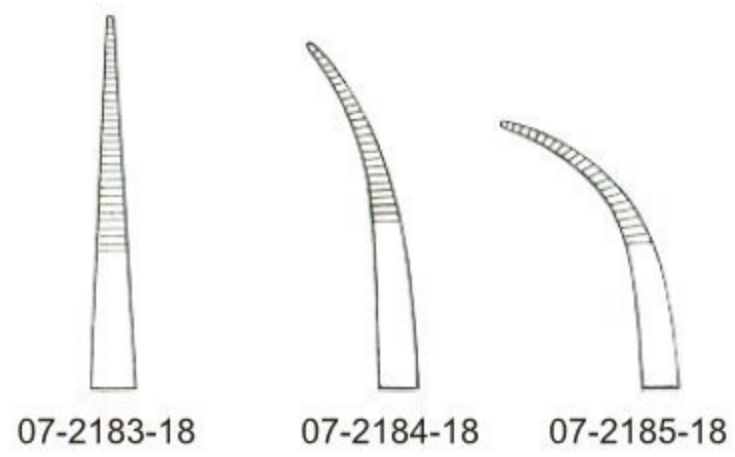

07-2183-18 07-2184-18 07-2185-18

Artery Forceps ● EN
 Arterienklemmen ● DE
 Pinzas hemostaticas ● ES

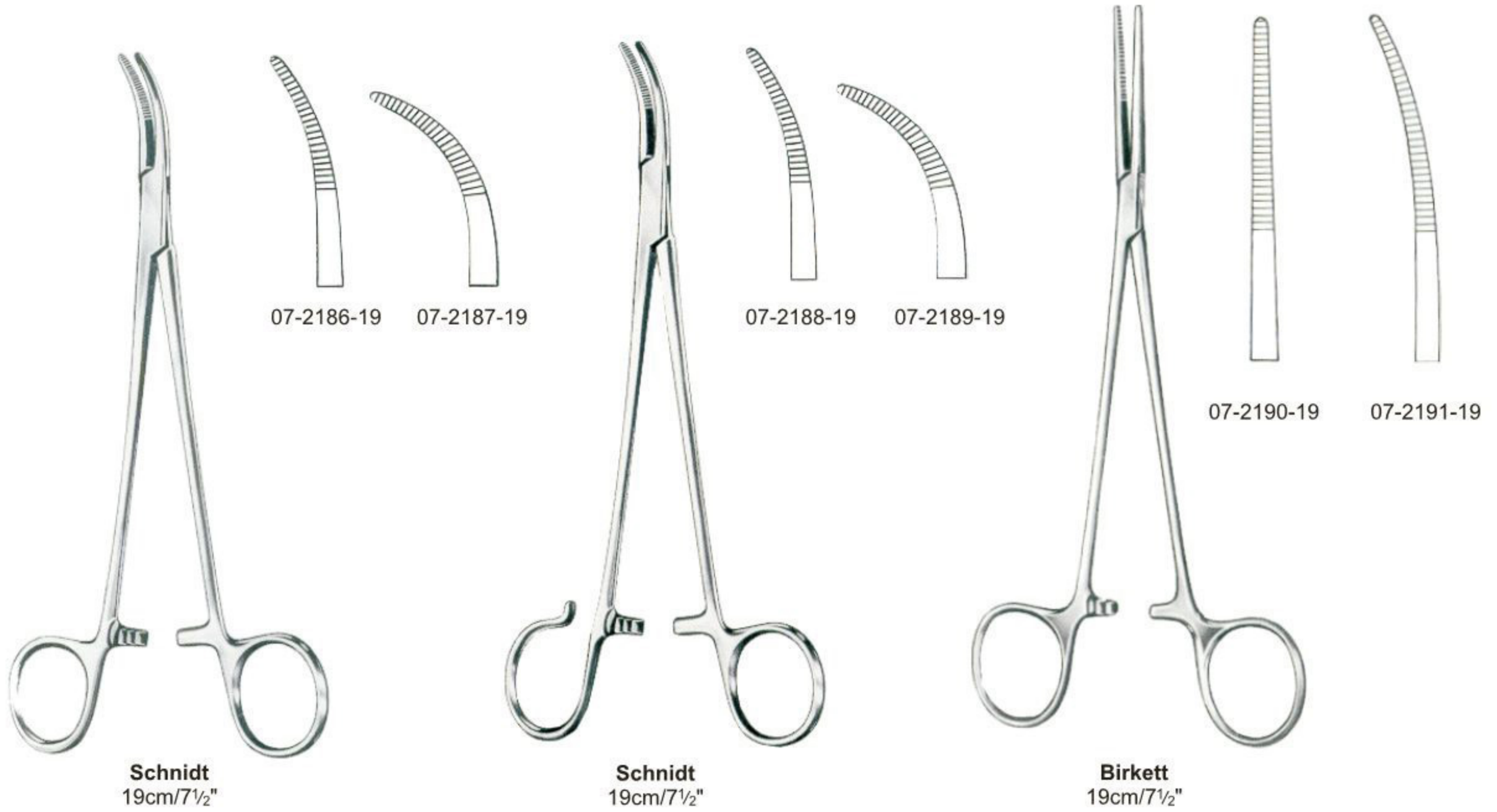

Schnidt
19cm/7½"

Schnidt
19cm/7½"

Birkett
19cm/7½"



Bengolea

20cm/8"	07-2192-20	07-2193-20	07-2194-20	07-2195-20
22cm/8¾"	07-2192-22	07-2193-22	07-2194-22	07-2195-22
24cm/9½"	07-2192-24	07-2193-24	07-2194-24	07-2195-24
26cm/10¼"	07-2192-26	07-2193-26	07-2194-26	07-2195-26



Bridge
 27cm/10½"

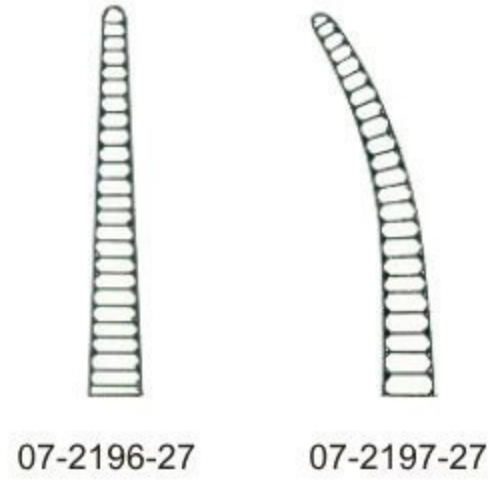

Roberts
 22cm/8¾"

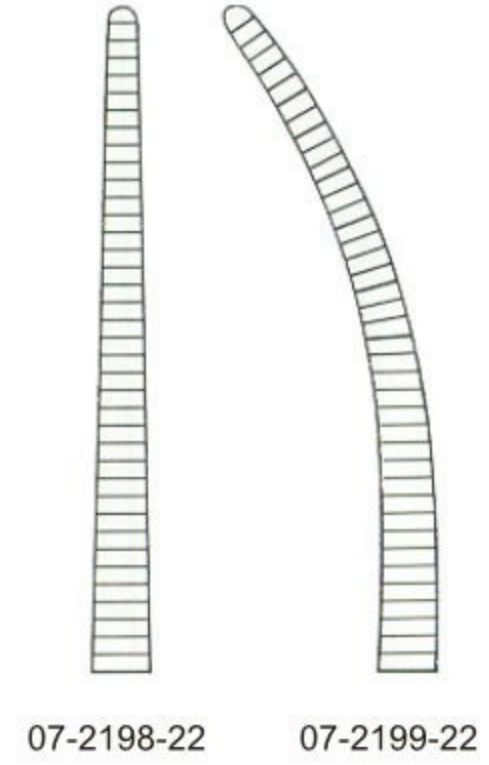

Kelly

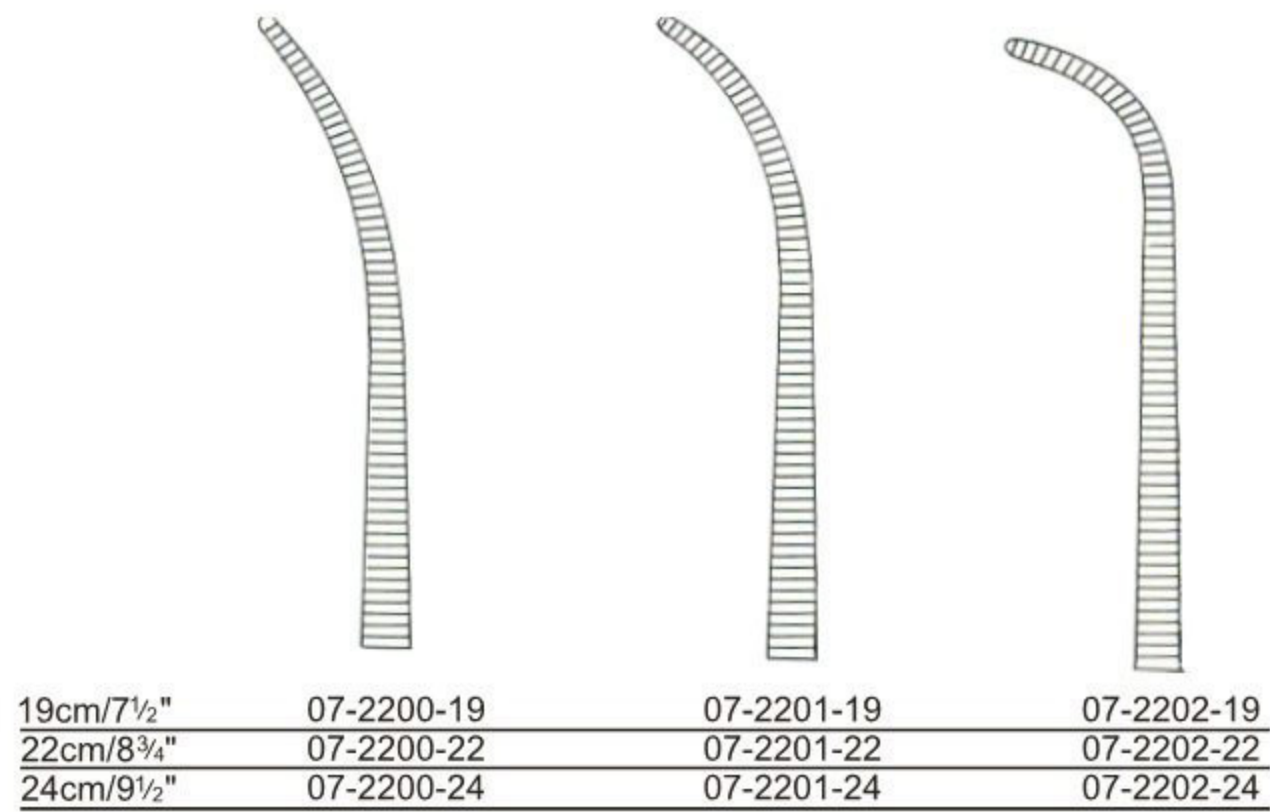

Artery Forceps ● EN
 Arterienklemmen ● DE
 Pinzas hemostaticas ● ES



Crafoord-Sellors

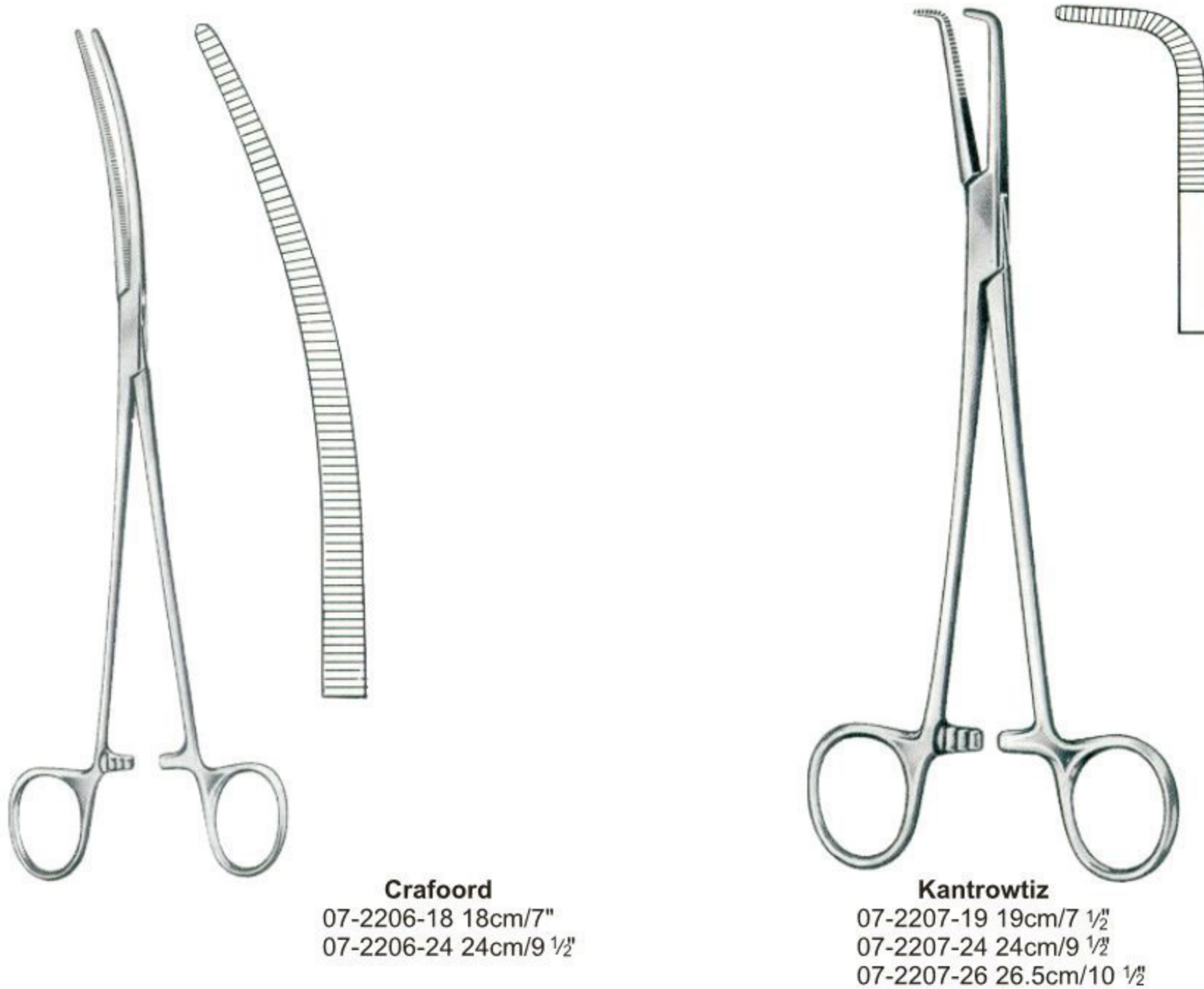



Rumel
 23cm/9"



07-2208-23



07-2209-23



07-2210-23



07-2211-23



07-2212-23



Johns Hopkins
 07-2213-20
 20cm/8"



Zenker
 29.5cm/11½"



07-2214-29



07-2215-29

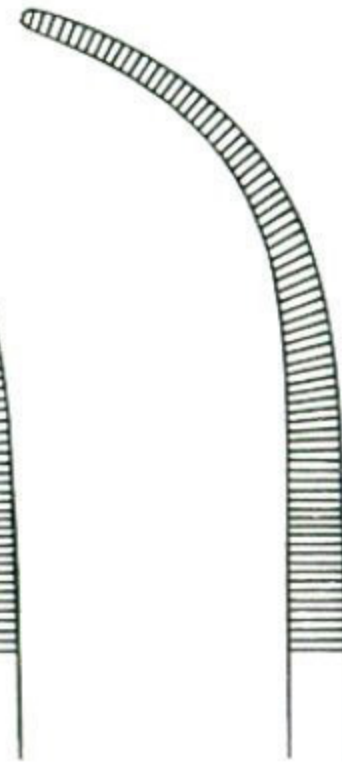

07-2216-29

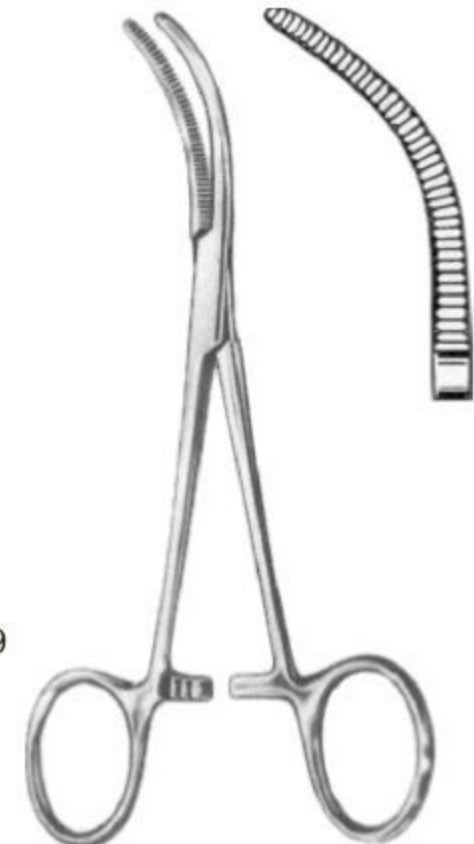

Baby-Overholt
 07-2217-13
 13.5cm/5¼"

- Artery Forceps ●— EN
- Arterienklemmen ●— DE
- Pinzas hemostaticas ●— ES

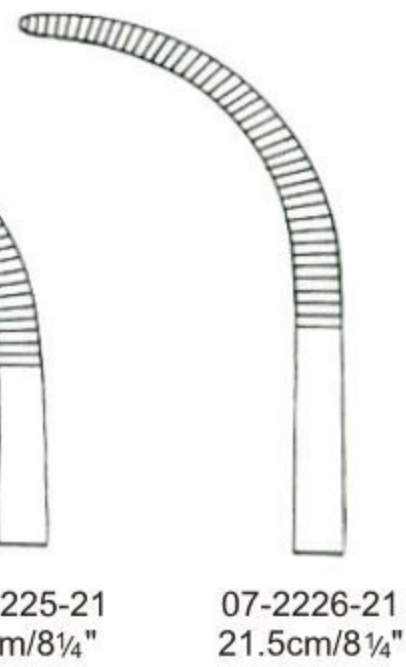
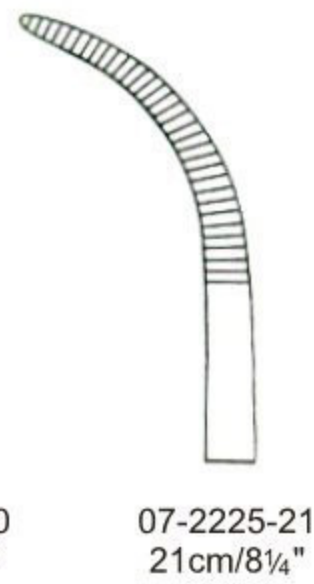
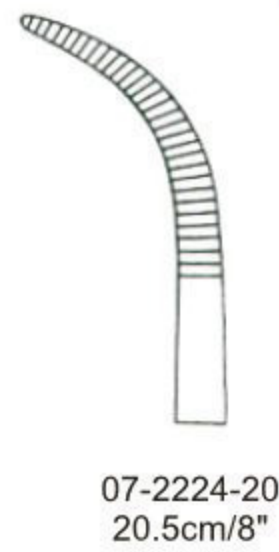
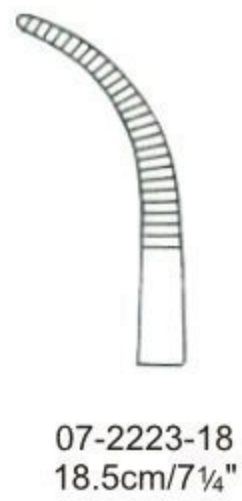
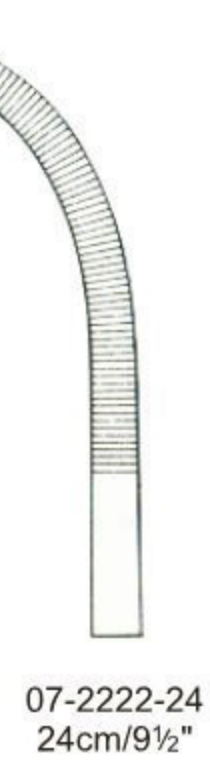
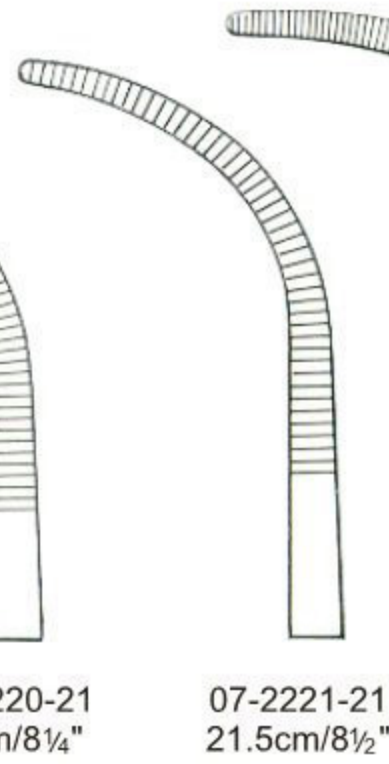
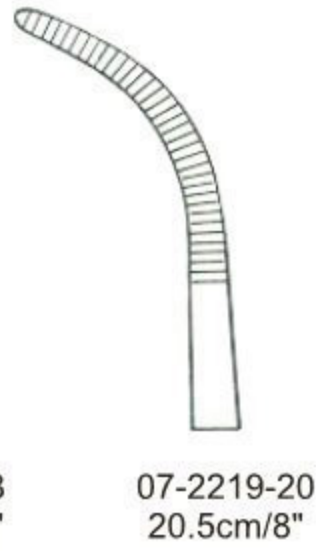
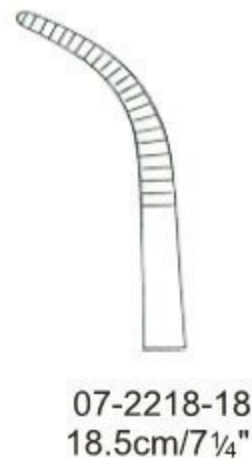



Overholt-Geissendorfer
 21cm/8¼"
 27cm/10½"

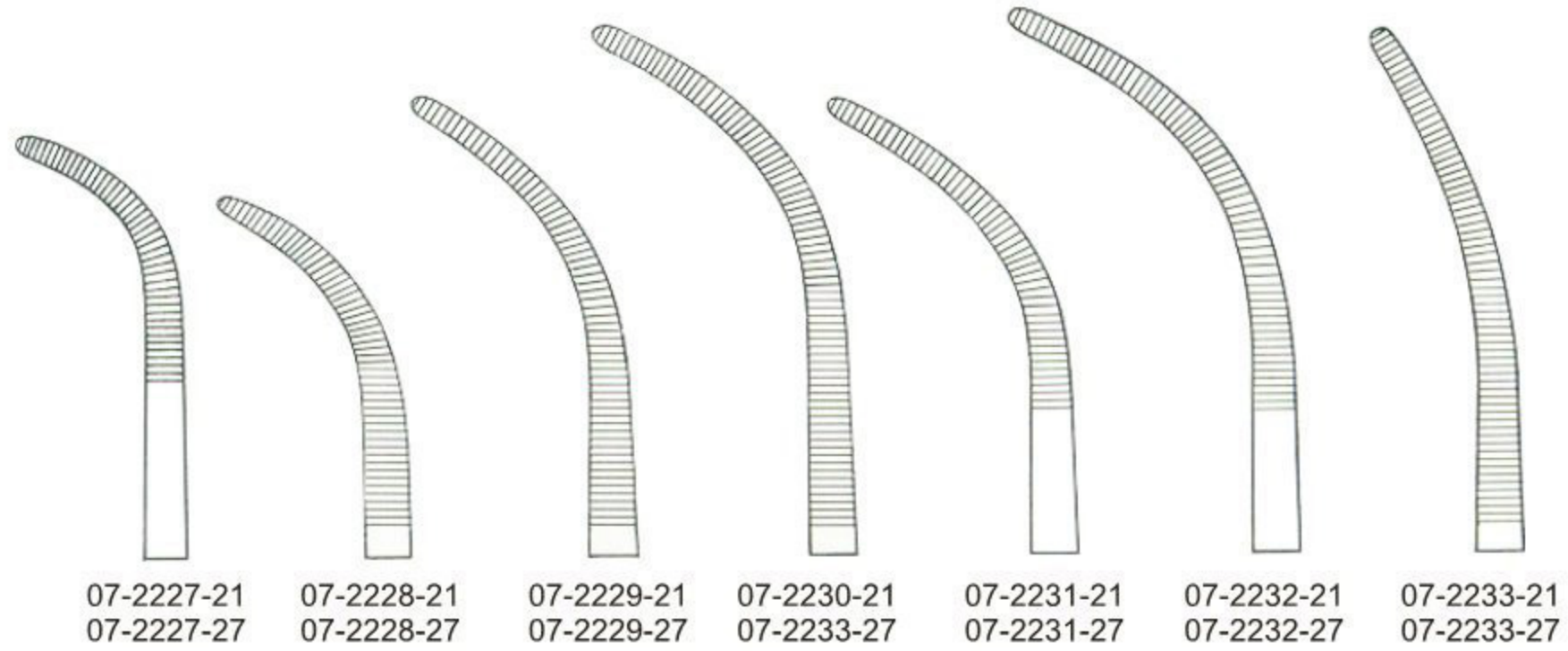

Overholt-Mixter
 07-2234-21
 21cm/8¼"



Heiss
 20cm/8"

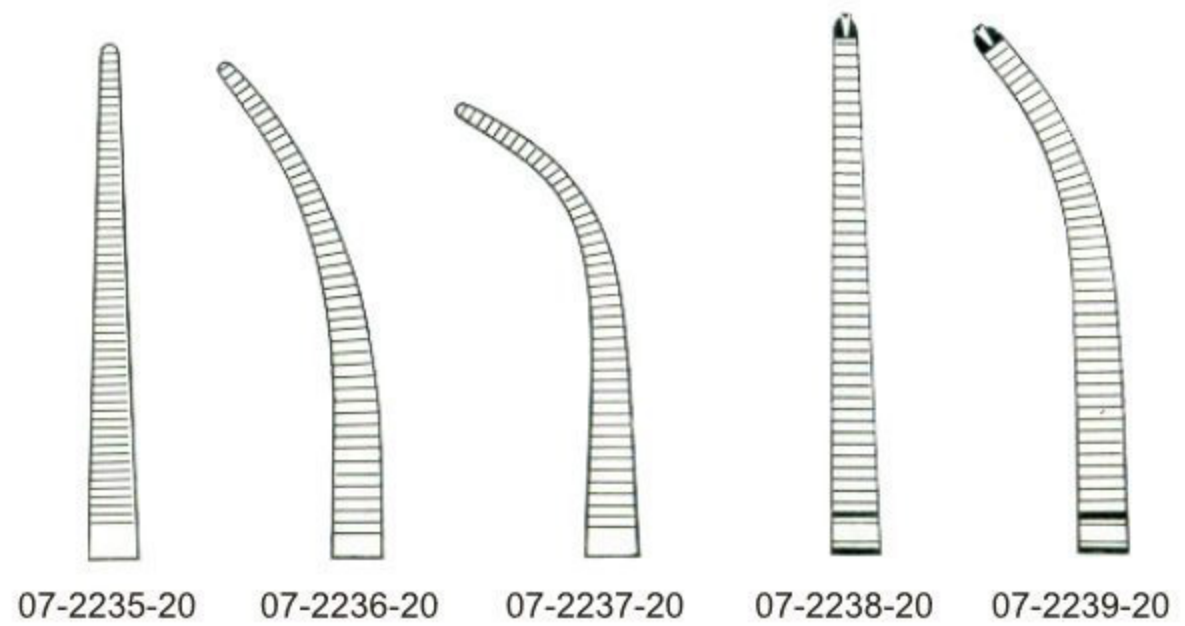



Meeker
 07-2240-27
 27 cm/10½"



Toennis
 21 cm/8¼"
 26 cm/10¼"

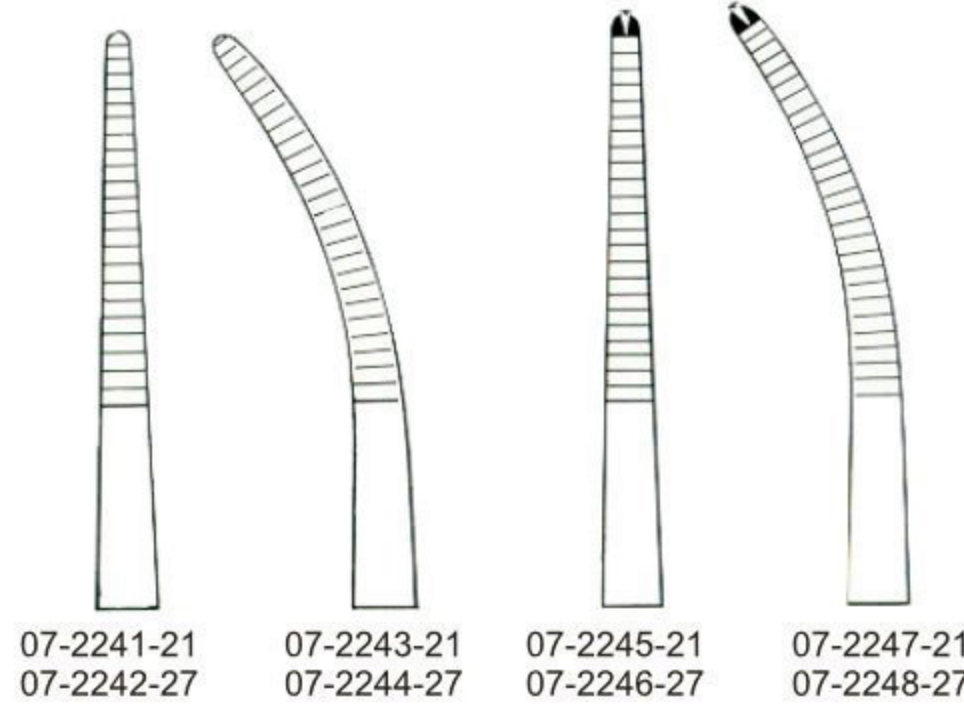

07-2241-21 07-2242-27
 07-2243-21 07-2244-27
 07-2245-21 07-2246-27
 07-2247-21 07-2248-27



Lower
 07-2249-18
 18 cm/7"



Gemini

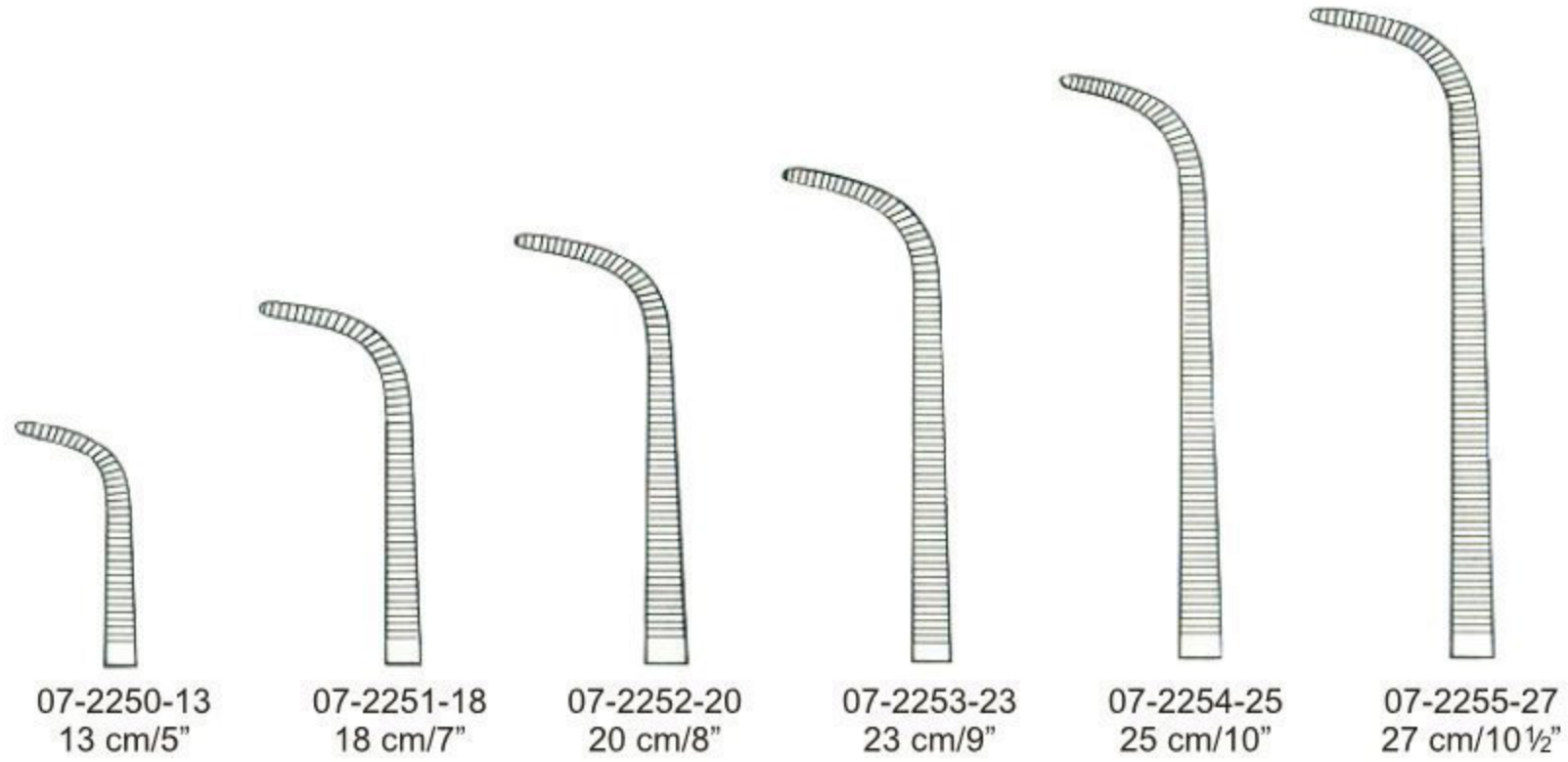

07-2250-13 13 cm/5"
 07-2251-18 18 cm/7"
 07-2252-20 20 cm/8"
 07-2253-23 23 cm/9"
 07-2254-25 25 cm/10"
 07-2255-27 27 cm/10½"



Mini-Gemini

07-2256-18
18 cm/7"



07-2256-22
22 cm/8¾"



07-2256-25
25 cm/10"



07-2256-28
28 cm/11"

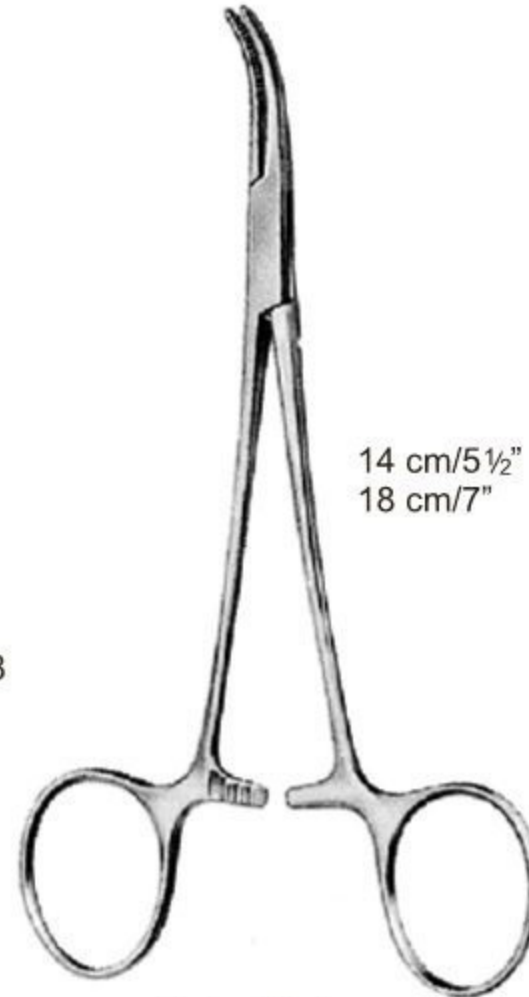

Baby-Mixer

14 cm/5½"
18 cm/7"



07-2257-14
07-2257-18



07-2258-14
07-2258-18



Mixer

07-2259-15 15 cm/6"
07-2259-19 19 cm/7½"



Mixer-O'Shaugnessy

07-2260-15 15.5 cm/6"
07-2260-19 19.0 cm/7½"

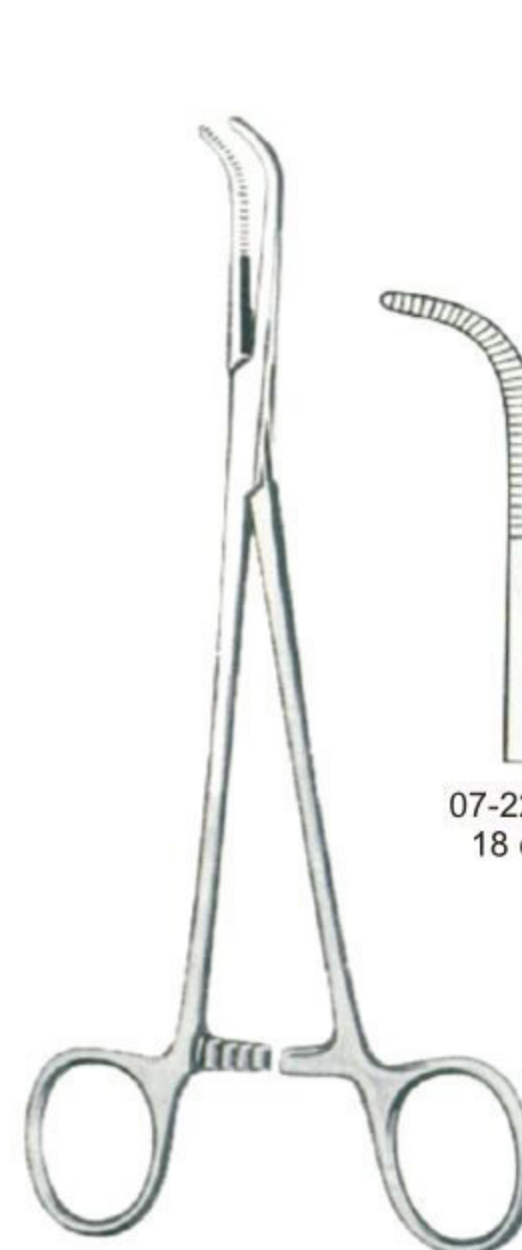

Mixer-Slim

07-2261-18
18 cm/7"



07-2261-23
23 cm/9"

- Artery Forceps ● EN
- Arterienklemmen ● DE
- Pinzas hemostaticas ● ES



07-2262-22
22 cm/8¾"

Mixer



07-2262-25
25 cm/10"

07-2262-28
28 cm/11"



Mixer
07-2263-22
22 cm/8¾"



Wickstroem
07-2264-20
20 cm/8"



Finocchietto
07-2265-24
24 cm/9½"



Mc Quigg-Mixer
07-2266-22
22 cm/8¾"



Lawrence
 07-2267-27
 27.5 cm/10¾"



Lahey (Sweet)

07-2268-19
 19 cm/7½"

07-2269-23
 23 cm/9"

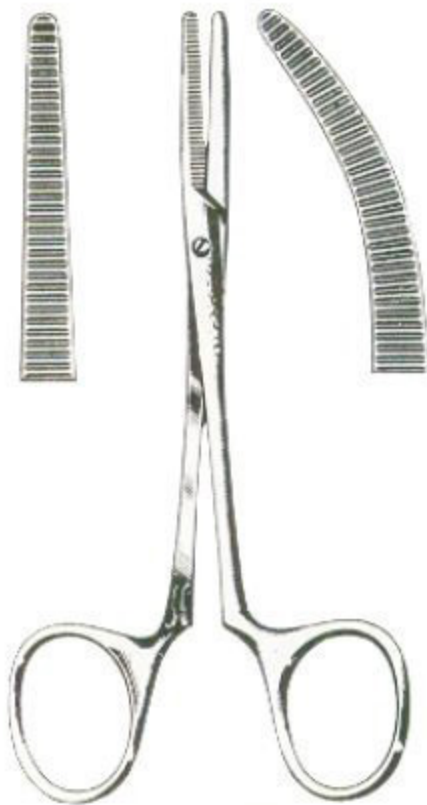

Spencer-Wells

- | | | |
|------------|----------|------------|
| 07-2270-13 | 13 cm/5" | 07-2271-13 |
| 07-2270-15 | 15 cm/6" | 07-2271-15 |
| 07-2270-18 | 18 cm/7" | 07-2271-18 |
| 07-2270-20 | 20 cm/8" | 07-2271-20 |
| 07-2270-23 | 23 cm/9" | 07-2271-23 |



Spencer-Wells

- | | | |
|------------|------------|------------|
| 07-2272-13 | 13 cm/5" | 07-2273-13 |
| 07-2272-14 | 14 cm/5 ½" | 07-2273-14 |
| 07-2272-15 | 15 cm/6" | 07-2273-15 |
| 07-2272-18 | 18 cm/7" | 07-2273-18 |
| 07-2272-20 | 20 cm/8" | 07-2273-20 |
| 07-2272-23 | 23 cm/9" | 07-2273-23 |

Artery Forceps ● EN
 Arterienklemmen ● DE
 Pinzas hemostaticas ● ES



Rogers

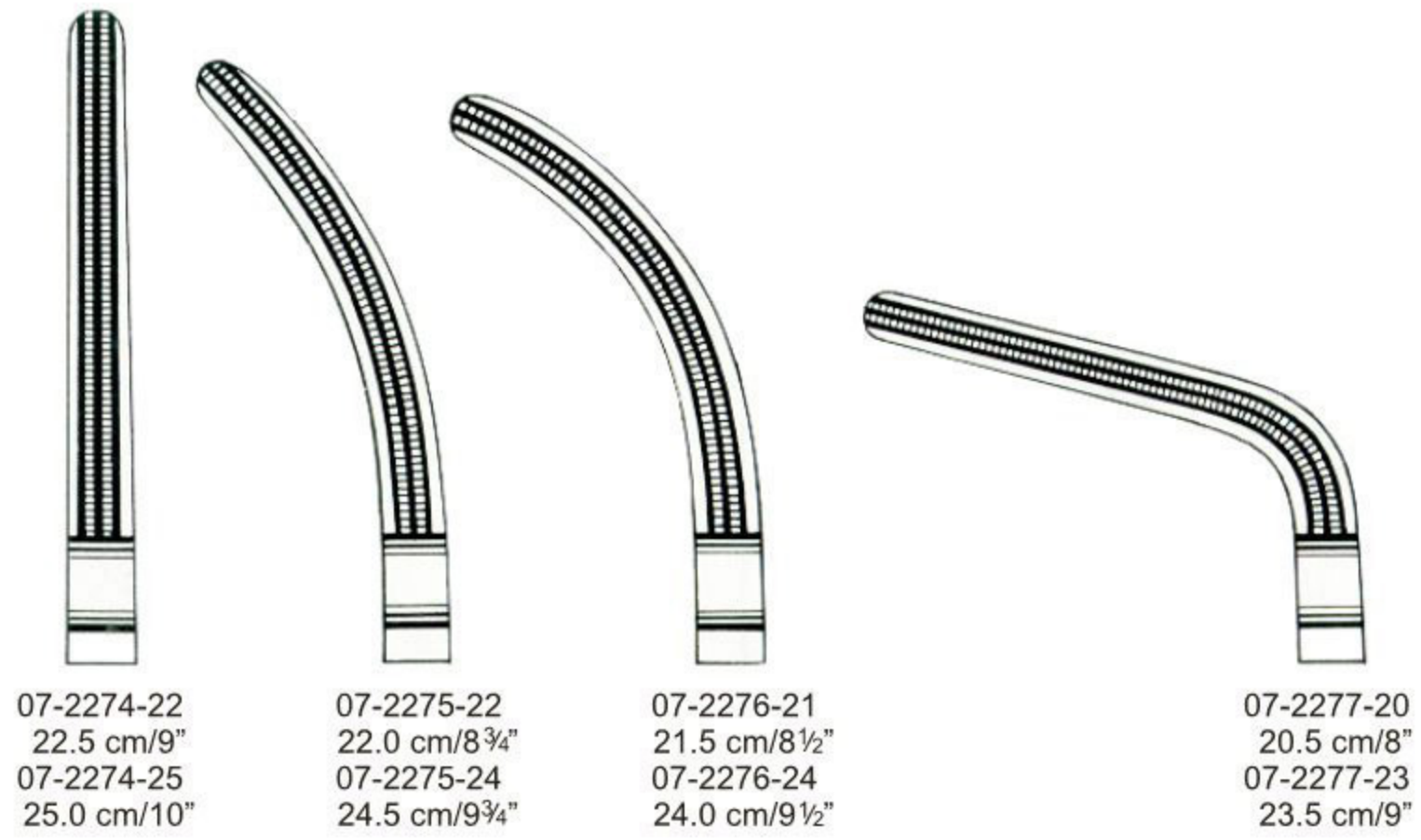

07-2274-22
 22.5 cm/9"
 07-2274-25
 25.0 cm/10"

07-2275-22
 22.0 cm/8¾"
 07-2275-24
 24.5 cm/9¾"

07-2276-21
 21.5 cm/8½"
 07-2276-24
 24.0 cm/9½"

07-2277-20
 20.5 cm/8"
 07-2277-23
 23.5 cm/9"



Heaney

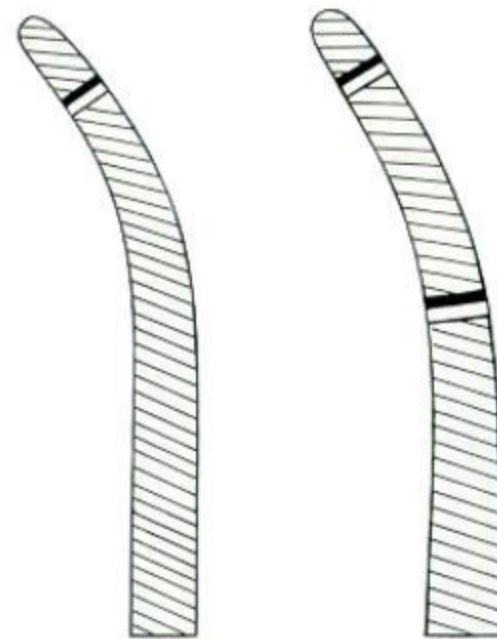

19.5 cm/7½" 07-2278-19
 21.5 cm/8¼" 07-2278-21
 23.5 cm/9" 07-2278-23

07-2279-19
 07-2279-21
 07-2279-23



Heaney-Slim
 07-2280-21
 21 cm/8¼"

EN —● Ophthalmologie. Ophthalmology, Oftalmoloia
 DE —● Keratoplastikmesser, Stanzen Meibel
 ES —● Keratoplastikmesser, Stanzen Meibel



Ballentine
 07-2281-21
 21cm/8¼"



Heaney-Ballentine
 07-2282-21
 21cm/8¼"



Tonsil Forceps



Fig. 1



Fig. 2

Negus
 07-2283-19 19cm/7½" 07-2284-19



Phaneuf
 21.5cm/8½"



07-2285-21

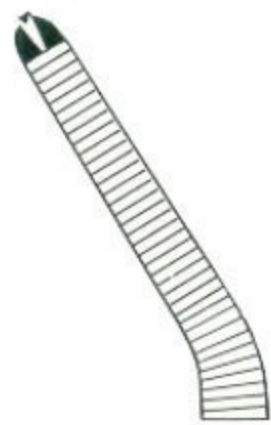

07-2286-21



Haemorrhoidal Clamps

Straight		Curved	
16cm/6¼"	07-2287-16	07-2288-16	
20cm/8"	07-2287-20	07-2288-20	

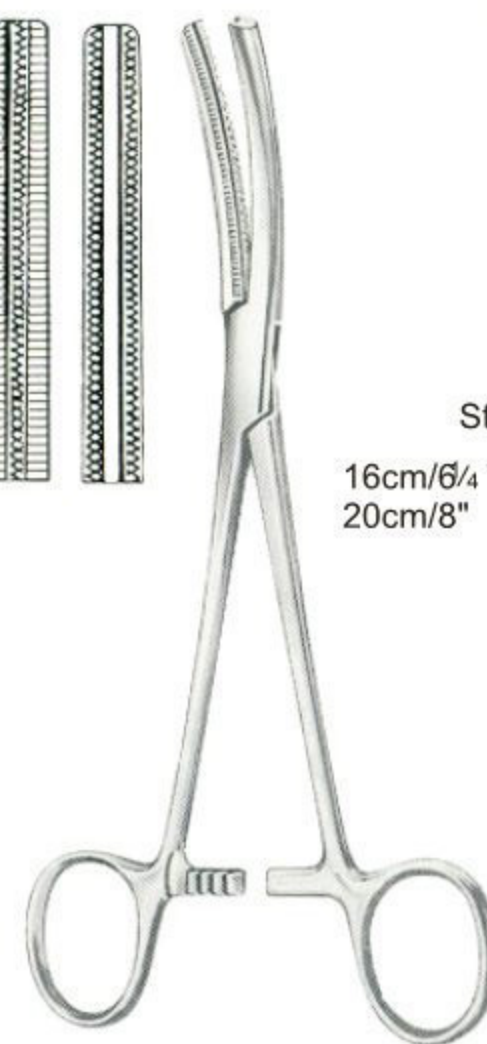

Fergusson



Buie
 07-2289-21
 21cm/8¼"

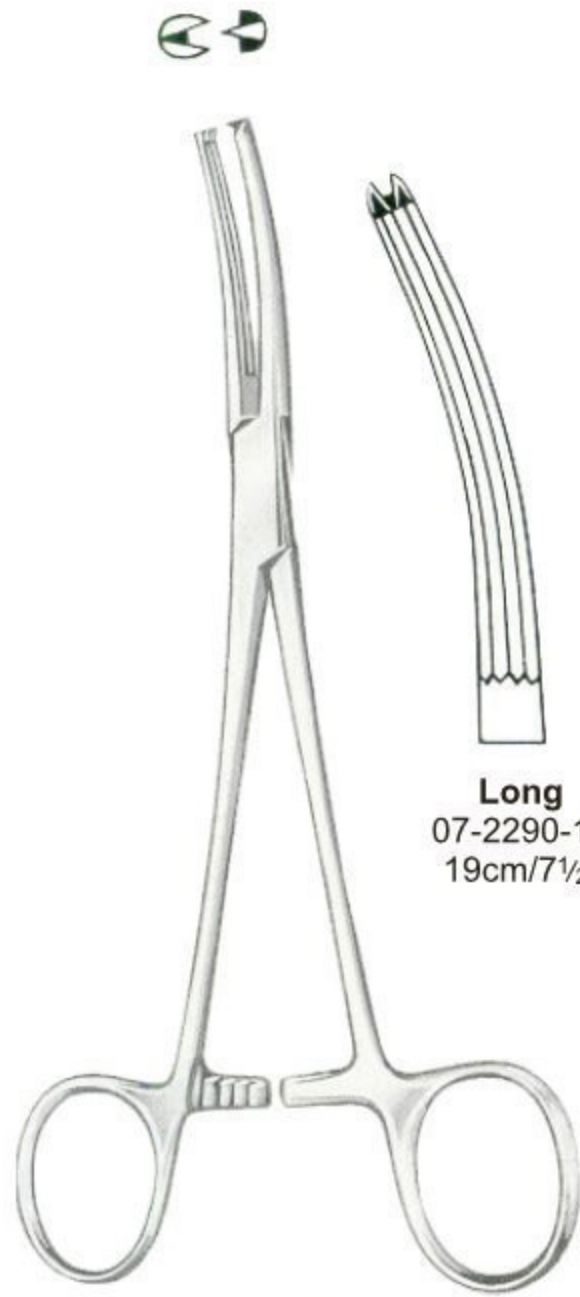

Long
 07-2290-19
 19cm/7½"



Garland
 07-2291-21
 21cm/8¼"

Gall Duct Clamps

Hysterectomy Forceps

Pressure Clamps



07-2292-23
 23cm/9"

07-2292-24
 24cm/9½"

Moynihan



07-2293-23

07-2294-23

Hozlbach
 23.5cm/9¼"



Zweifel
 07-2295-17
 17.5cm/7"

Scalp Flap Forceps

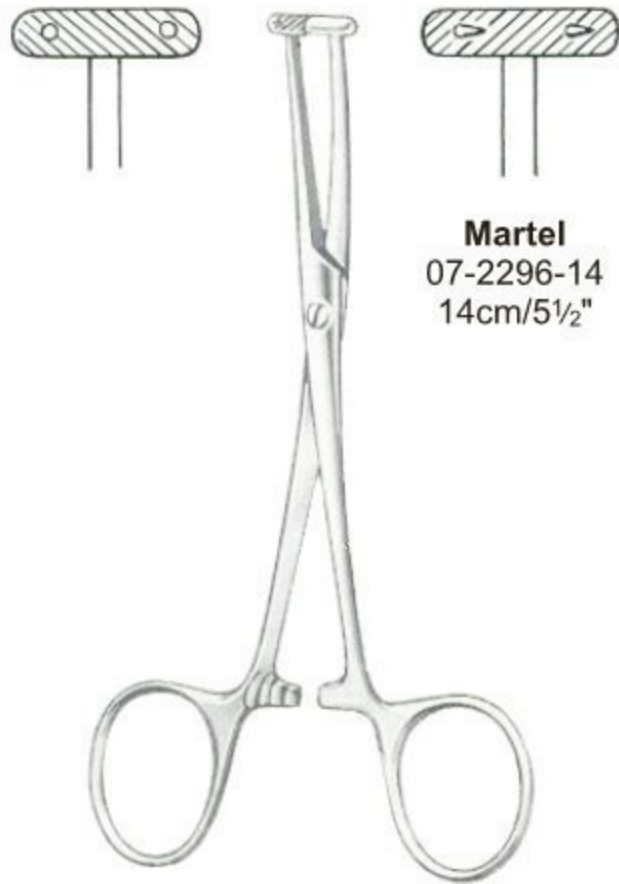

Martel
 07-2296-14
 14cm/5½"



Werheim
 07-2297-25
 25cm/10"



Werheim-Cullen
 07-2298-21
 21.5cm/8½"



Werheim
 07-2299-24
 24cm/9½"

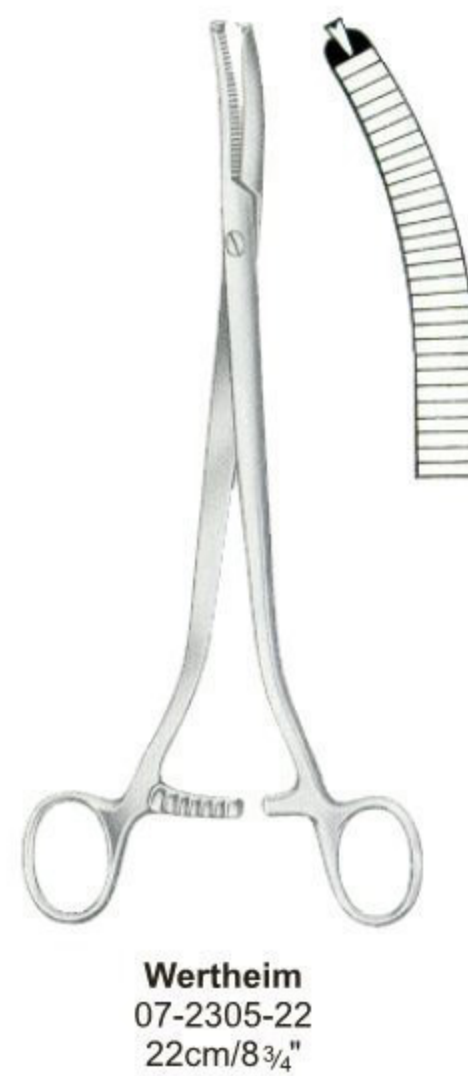
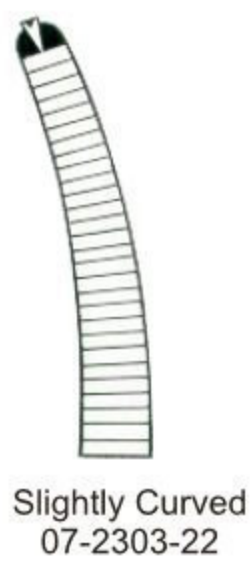
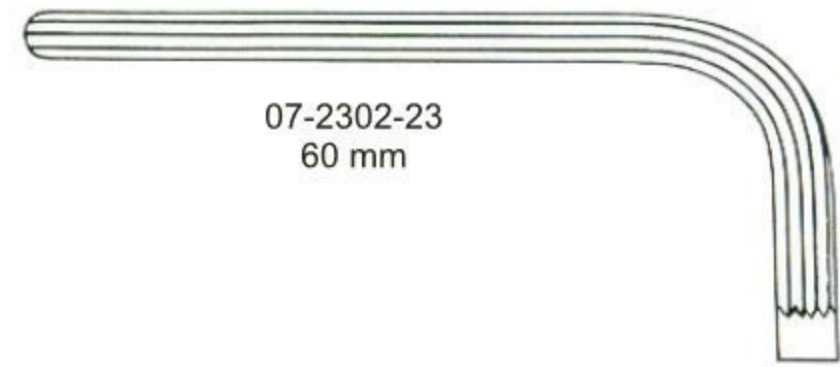
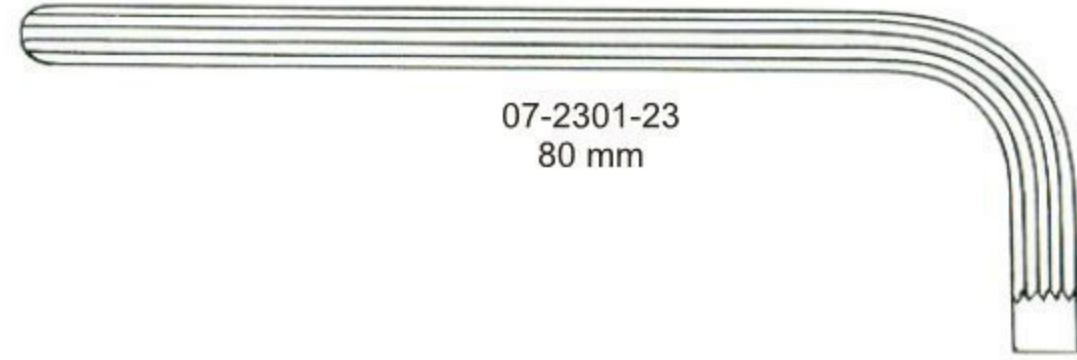
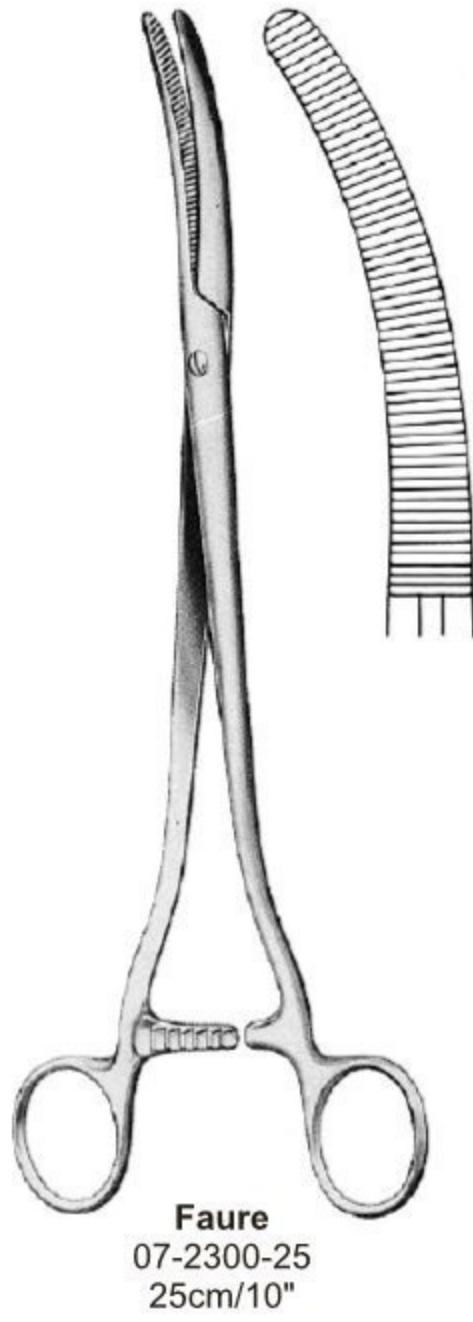



Wertheim
 07-2306-18
 18 cm/7"



Baby-Mikulicz
 07-2307-14
 14 cm/5½"



Mikulicz
 07-2308-18 18cm/7"
 07-2308-20 20cm/8"



Mikulicz
 07-2309-20
 20 cm/8"



Mikulicz
 07-2310-18
 18.5 cm/7 "

Artery Forceps ●— EN
 Arterienklemmen ●— DE
 Pinzas hemostaticas ●— ES



Mikulicz
 07-2311-18
 18 cm/7"

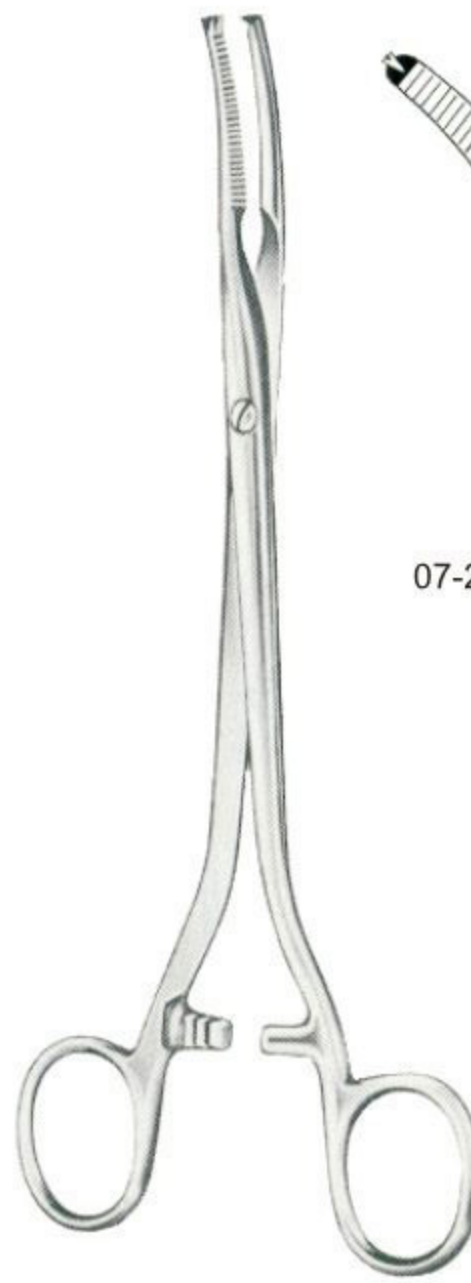

Mikulicz
 07-2312-20 20 cm/8" 07-2313-20

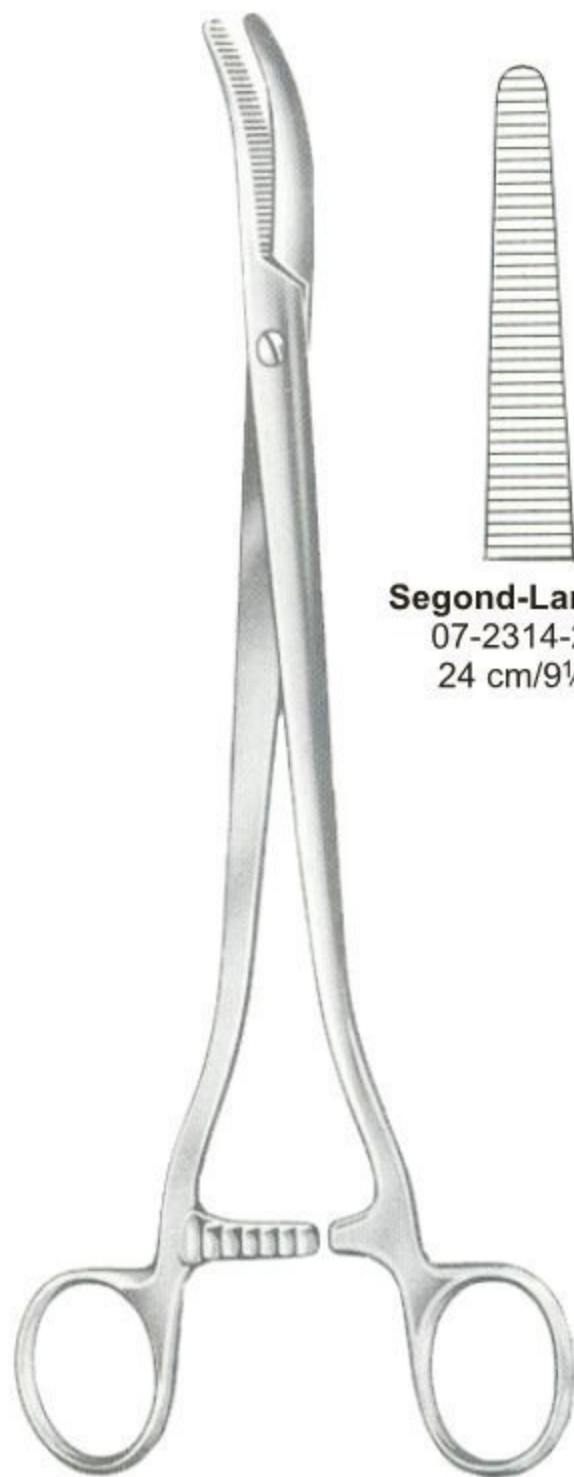

Segond-Landau
 07-2314-24
 24 cm/9½"

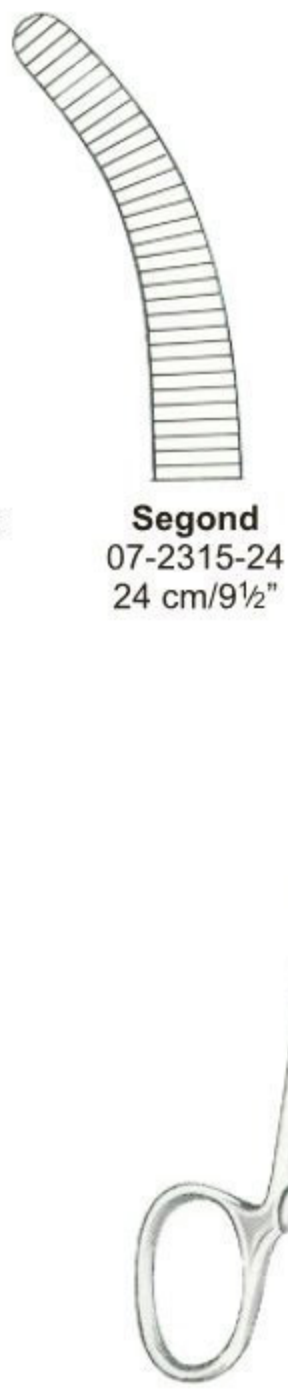

Segond
 07-2315-24
 24 cm/9½"



Faure
 07-2316-20 20 cm/8" 07-2317-20



Schindler
 07-2318-20
 20 cm/8"



Schadel
 07-2319-09 9 cm/3½"



Jones
 07-2320-05 5 cm/2"
 07-2320-09 9 cm/3 ½"



Engl-Modell
 07-2321-09 9 cm/3½"



Backhaus
 07-2322-09 9 cm/3 ½"
 07-2322-11 11 cm/4 ½"
 07-2322-13 13 cm/5"
 07-2322-15 15 cm/6"

With clip for Tubing or Cable



07-2323-11 11 cm/4 ½"
 07-2323-13 13 cm/5"



Peers-Bertram
 07-2324-14 14.5 cm/5¾"



Tohoku
 07-2325-10 10 cm/4"
 07-2325-13 13 cm/5"

Artery Forceps ● EN
 Arterienklemmen ● DE
 Pinzas hemostaticas ● ES



Roder
 07-2326-13 13 cm/5"
 07-2326-15 15 cm/6"



Lorna
 07-2327-10 10 cm/4"
 07-2327-13 13 cm/5"



Bernhard
 07-2328-16 16.5 cm/6 1/2"



Lane
 07-2329-20
 20 cm/8"



Doyen
 07-2330-18
 18 cm/7"

Artery Forceps ● EN
 Arterienklemmen ● DE
 Pinzas hemostaticas ● ES



07-2331-14 14 cm/5 1/2"
 07-2331-15 15 cm/6"
 07-2331-18 18 cm/7"
 07-2331-20 20 cm/8"



07-2332-14
 14.5 cm/5 3/4"



07-2333-16 16.5 cm/6 1/2"
 07-2333-18 18.0 cm/7"



07-2334-15 15 cm/6"
 07-2334-18 18 cm/7"
 07-2334-20 20 cm/8"



Mohr
 07-2335-50 50 mm
 07-2335-60 60 mm
 07-2335-70 70 mm
 07-2335-80 80 mm

Sizes
 mm
 13
 17
 20
 25
 30

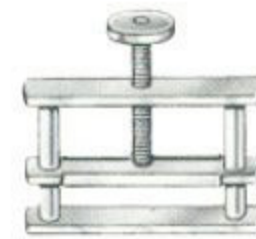

Hoffmann
 07-2336-13
 07-2336-17
 07-2336-20
 07-2336-25
 07-2336-30



Hoffmann
 07-2337-13
 07-2337-17
 07-2337-20
 07-2337-25
 07-2337-30

- EN** Cotton Swab Forceps
- DE** Tupfer-und Kornzangen
- ES** Pinzas para tapones y curaciones

Page 141 to 144



EN —● Cotton Swab, Polypus and Dressing Forceps
 DE —● Tupferzangen, Korn-(Polypen-)Zangen
 ES —● Pinzas para tapones, Pinzas para pólipos y vendajes



Ulrich

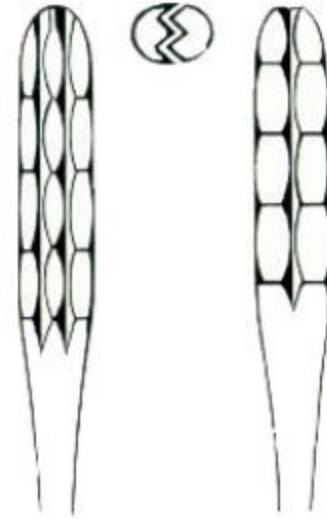

Straight

08-2401-22
 08-2401-25
 08-2401-27



Curved

22 cm/8¾"
 25 cm/10"
 27 cm/10½"

08-2402-22
 08-2402-25
 08-2402-27



Lister

08-2403-13	13 cm/5"	08-2404-13
08-2403-15	15 cm/6"	08-2404-15
08-2403-18	18 cm/7"	08-2404-18



Bryant

08-2405-13
 13 cm/5"



Bryant

08-2406-13
 13 cm/5"

Cotton Swab Forceps ● EN
 Tupferzangen ● DE
 Pinzas para tapones ● ES



Gross-Maier



Straight

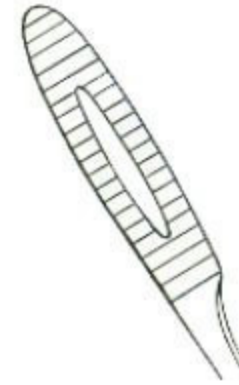

Curved

With Ratchet

08-2407-20	20 cm/8"	08-2408-20
08-2407-25	25 cm/10"	08-2408-25

Without Ratchet

08-2409-20	20 cm/8"	08-2410-20
08-2409-25	25 cm/10"	08-2410-25



Pelkmann
 25 cm/10"



08-2411-25



08-2412-25

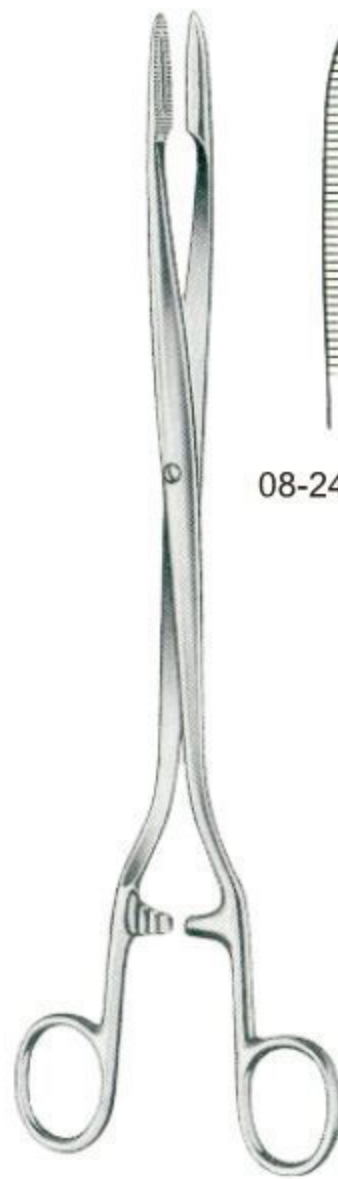

Sims-Maier
 28 cm/11"



08-2413-28



08-2414-28



Duplay
 20 cm/8"



08-2415-20



08-2416-20

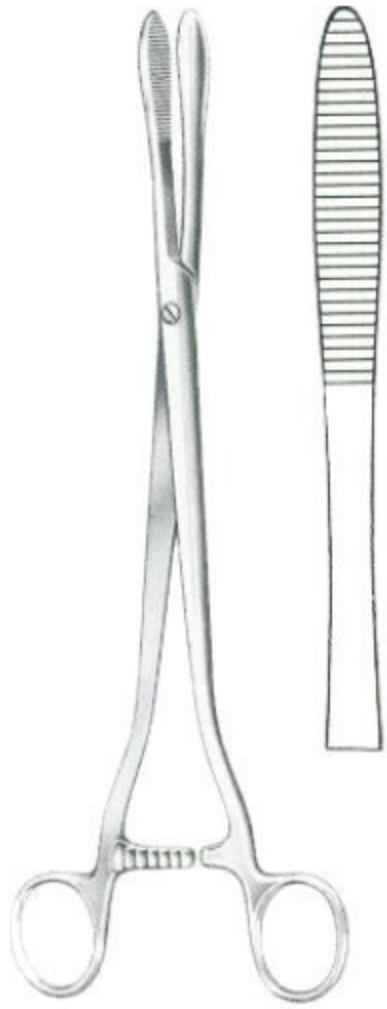

Collin
 08-2417-25
 25cm/10"



Cheron
 08-2418-25
 25cm/10"



Emmet
 08-2419-21
 21cm/8 1/4"



Bozemann
 08-2420-26
 26cm/10 1/4"



Bozemann
 26cm/10 1/4"



08-2421-26



08-2422-26

Smooth

Polypus, Tumor, Cotton Swab Forceps ● EN
 Tupferzangen, Polypen-, Tumor-, Schwammzangen ● DE
 Pinzas para pólipos, tumores y esponjas ● ES

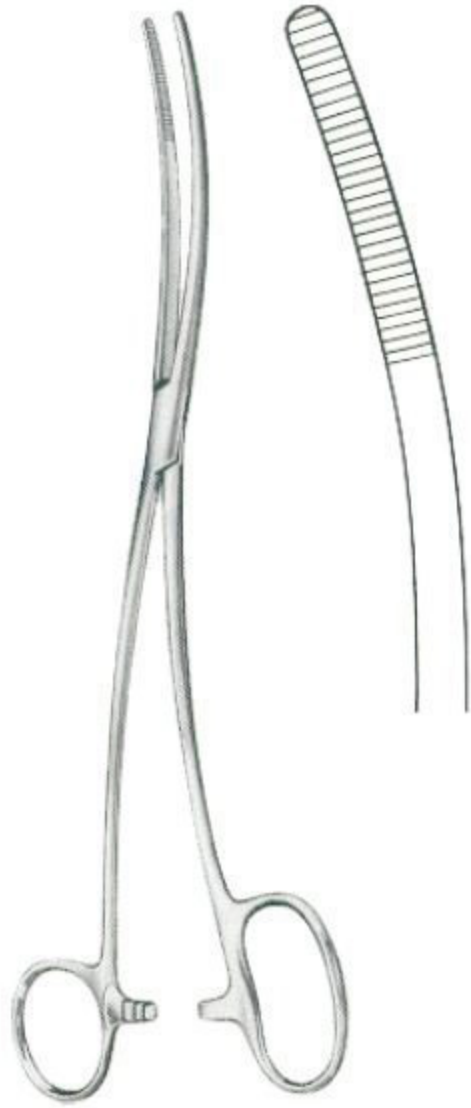

Bozemann-Douglas
 08-2423-26
 26cm/10¼"

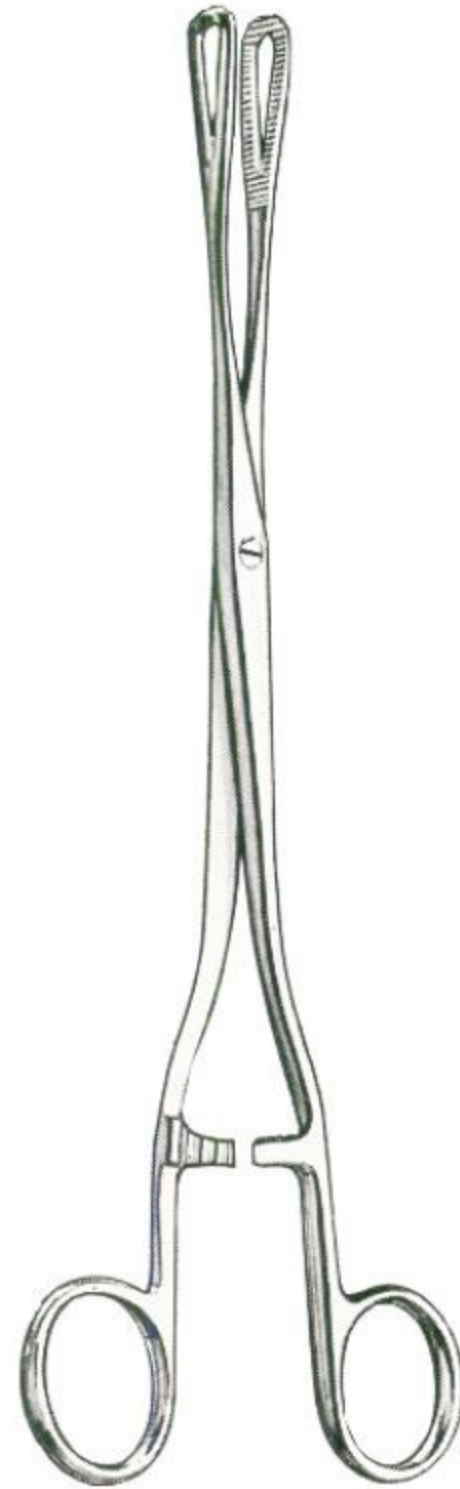

Rampley
 08-2424-18 18cm/7"
 08-2424-24 24cm/9 ½"



Rampley
 08-2425-18 18cm/7"
 08-2425-24 24cm/9 ½"



Foerster

18 cm/7"
 20 cm/8"
 24 cm/9½"
 25 cm/10"



08-2426-18
 08-2426-20
 08-2426-24
 08-2426-25

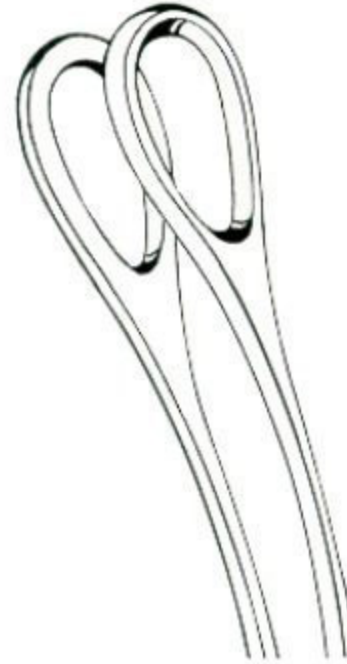

08-2427-18
 08-2427-20
 08-2427-24
 08-2427-25



08-2428-18
 08-2428-20
 08-2428-24
 08-2428-25

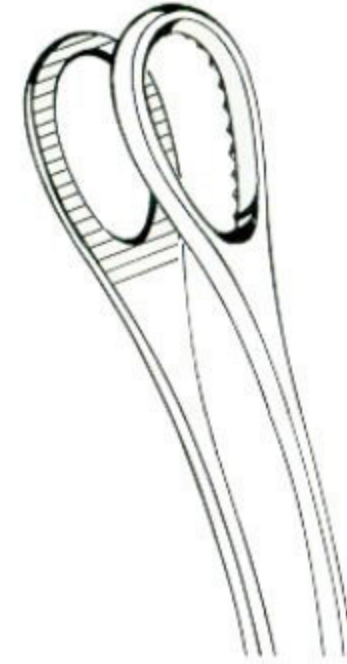

08-2429-18
 08-2429-20
 08-2429-24
 08-2429-25

EN Suture

DE Naht

ES Sutura

Page 145 to 175





Derf
 09-2501-12 12.0cm



Derf
 09-2502-12 12.5cm



Collier
 09-2503-12 12.5cm

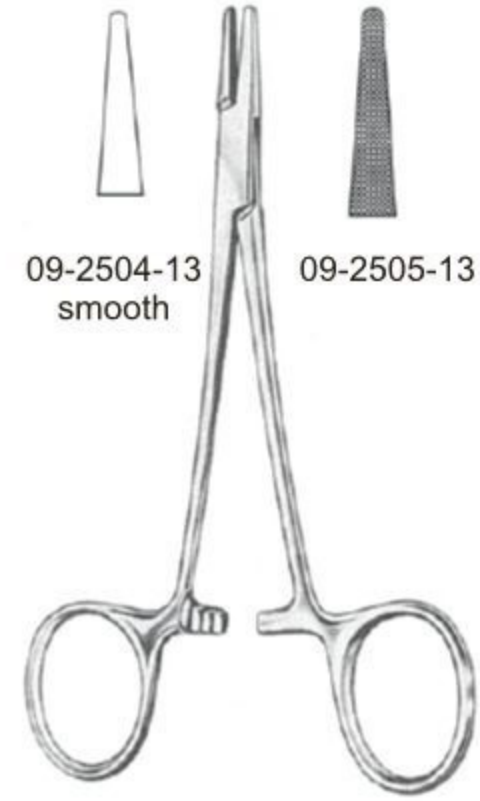

Webster
 13.0cm

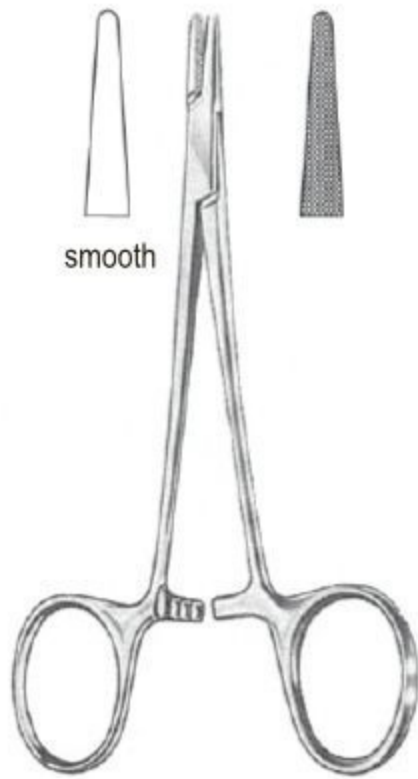

Halsey
 09-2506-13 13.0cm 09-2507-13

smooth jaws with special groove



Neivert
 09-2508-13 13.0cm



Hegar-Baumgartner
 09-2509-12 12.5cm
 09-2509-14 14.0cm



Brown
 09-2510-13 13.0cm
 09-2510-18 18.0cm

Needle Holders ●— EN
 Nadelhalter ●— DE
 Porta-agujas ●— ES



Mayo-Hegar
 09-2511-14 14.0cm 09-2512-14
 09-2511-15 15.0cm 09-2512-15
 09-2511-16 16.0cm 09-2512-16
 09-2511-18 18.0cm 09-2512-18
 09-2511-20 20.0cm 09-2512-20
 09-2511-22 22.0cm 09-2512-22
 09-2511-24 24.0cm 09-2512-24
 09-2511-26 26.0cm 09-2512-26
 09-2511-28 28.0cm 09-2512-28
 09-2511-30 30.0cm 09-2512-30



Mayo-Hegar
 09-2513-16 16.0cm
 09-2513-18 18.0cm
 09-2513-20 20.0cm



Crile-Murray
 09-2514-15 15.0cm



Crile-Wood
 09-2515-15 15.0cm
 09-2515-18 18.0cm
 09-2515-20 20.0cm



Hegar
 09-2516-20 20.0cm 09-2517-20
 09-2516-24 24.0cm 09-2517-24

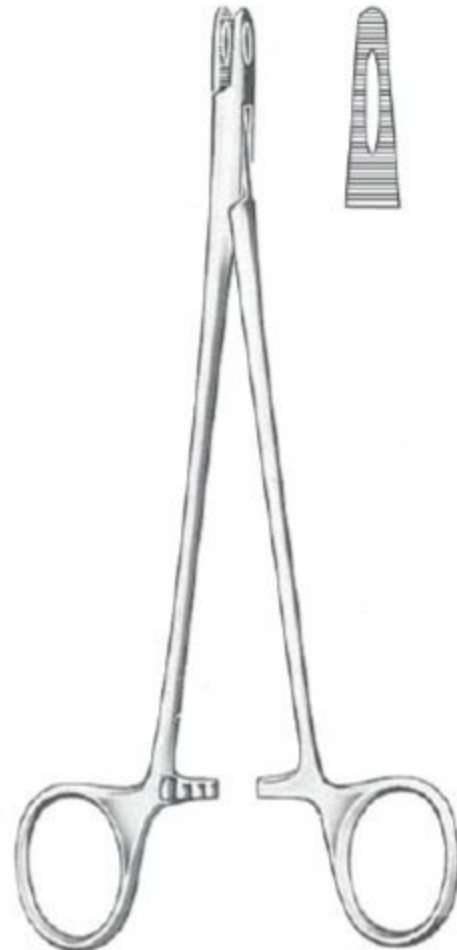

Adson
 09-2518-18 18.0cm



Heaney
 09-2519-21 21.0cm



Metzenbaum
 09-2520-18 18.0cm



Masson-Luethy
 09-2521-26 26.0cm

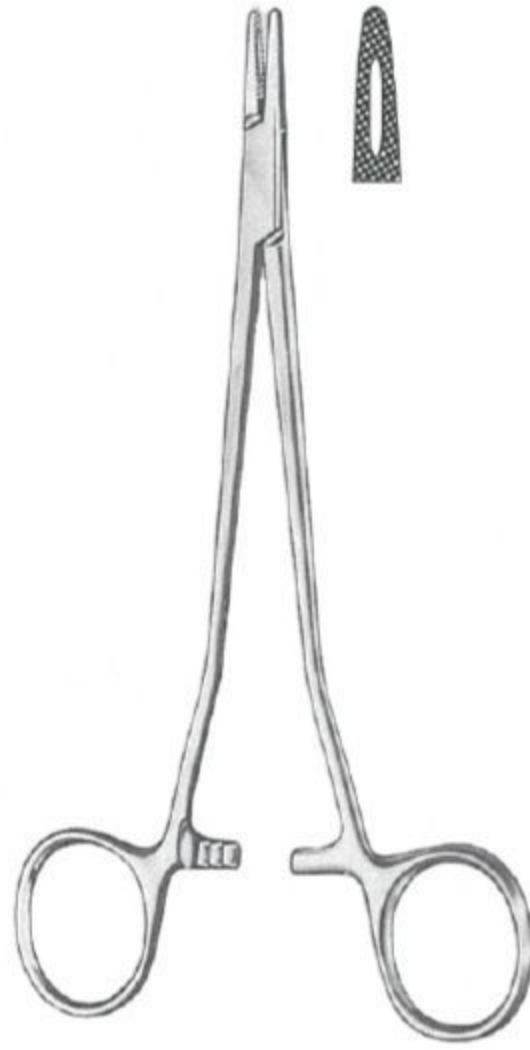

Sarot
 09-2522-18 18.0cm
 09-2522-26 26.0cm

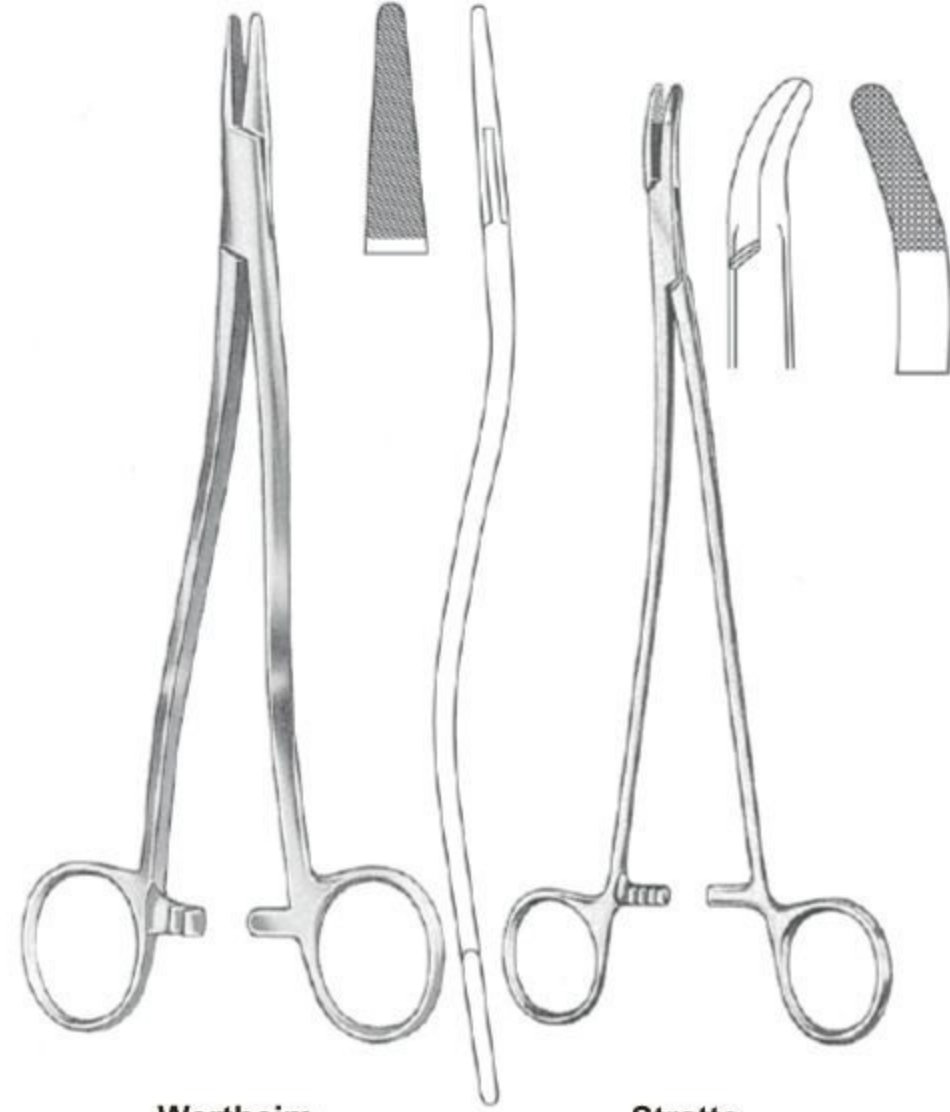

Wertheim
 09-2523-20 20.0cm
 09-2523-24 24.0cm

Stratte
 09-2524-23 23.0cm



Bruce-Clarke
 09-2525-12 12.5cm

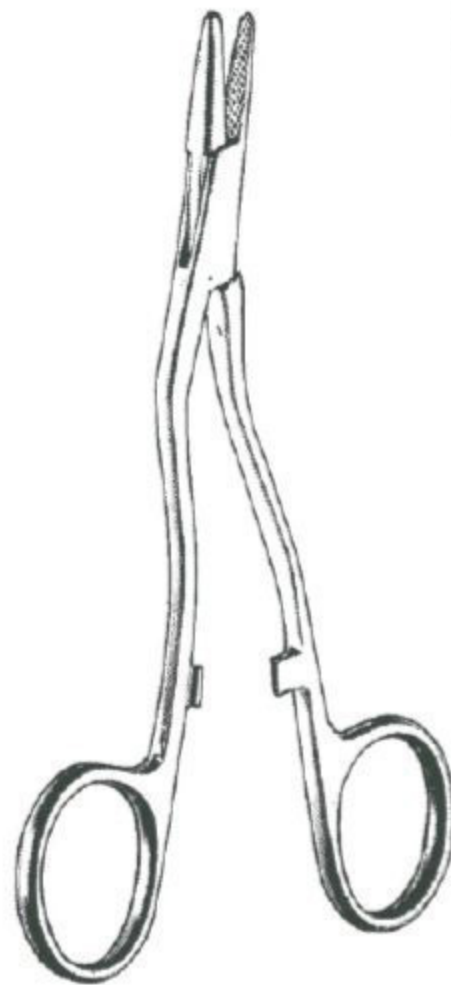

Kilner
 09-2526-13 13.5cm
 09-2526-16 16.5cm



Thomson-Walker
 09-2527-20 20.0cm

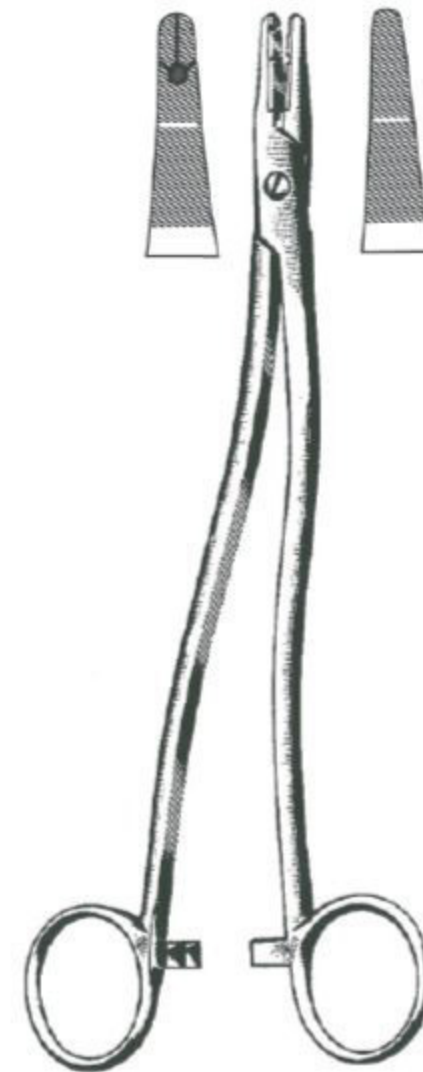

Bozemann
 09-2528-20 20.0cm
 09-2528-24 24.0cm

Needle Holders ● EN
 Nadelhalter ● DE
 Porta-agujas ● ES



Johnson
 09-2529-27 27.0cm



Finocchetto
 09-2530-18 18.0cm
 09-2530-20 20.0cm
 09-2530-27 27.0cm

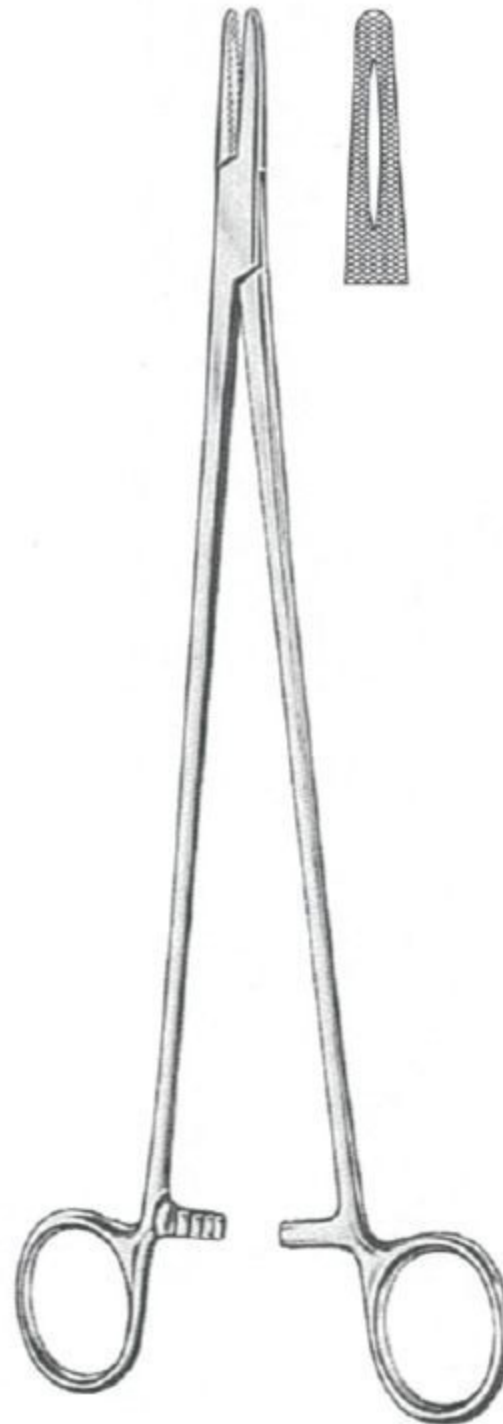

Masson
 09-2531-27 27.0cm



Wangenstein
 09-2532-27 27.0cm



Wangensteen
 09-2533-27 27.0cm



Jamison
 09-2534-23 23.5cm

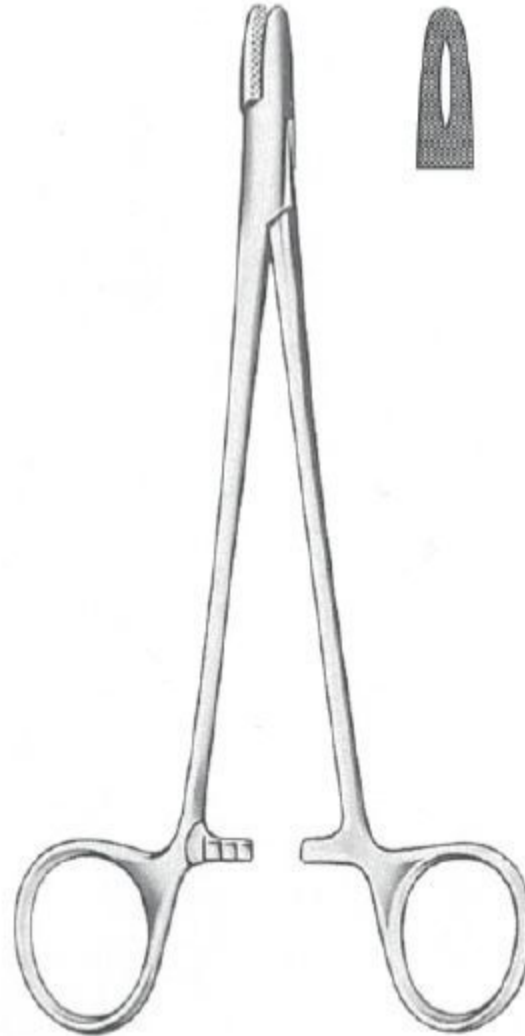

M.G.H.(mass-general-hospital)
 09-2535-17 17.0cm

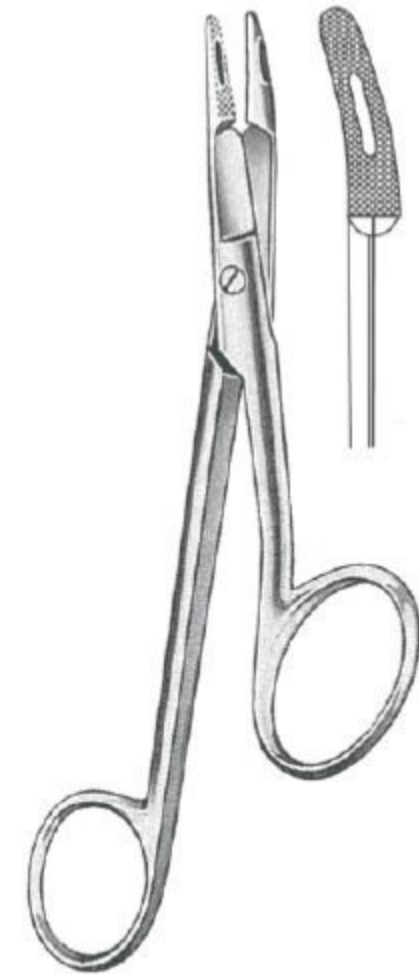

Gillies
 09-2536-16 16.0cm (right hand)
 09-2536-16 16.0cm (left hand)

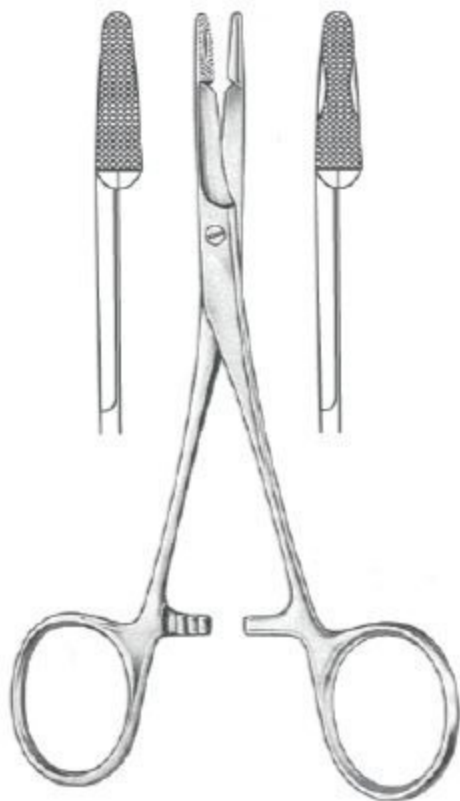

Olsen-Hegar
 09-2537-14 14.0cm 09-2538-14
 with blood groove



Olsen-Hegar
 09-2539-17 17.0cm

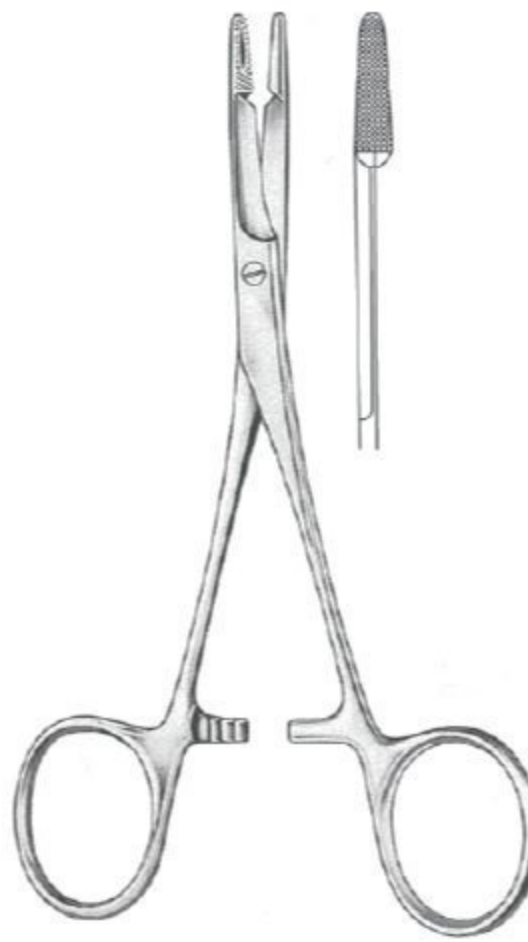

Olsen-Hegar
 09-2540-17 17.0cm

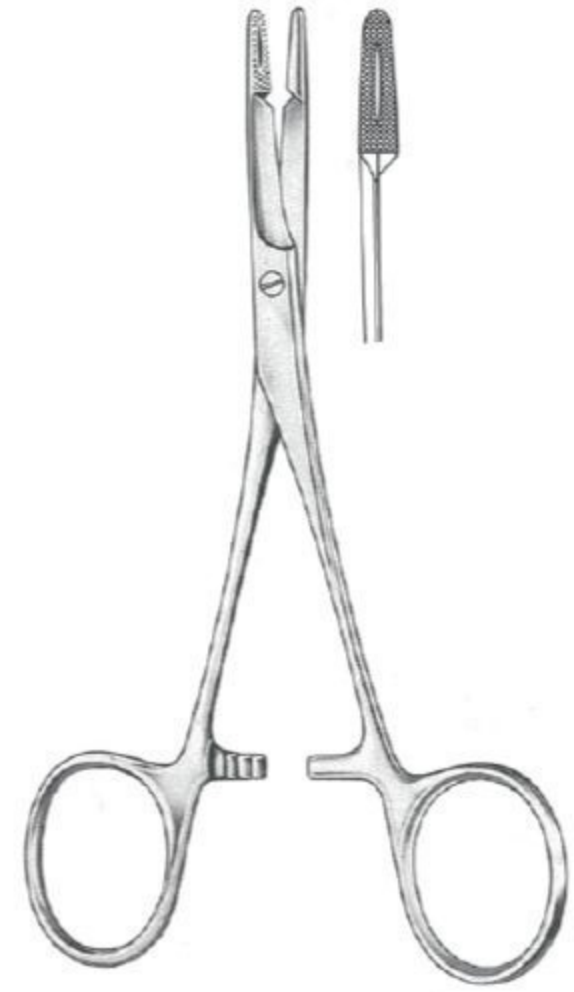

Olsen-Hegar
 09-2541-14 14.0cm
 09-2541-18 18.0cm

Needle Holders ●— EN
 Nadelhalter ●— DE
 Porta-agujas ●— ES



Crile
 09-2542-15 15.0cm



Toennis
 09-2543-18 18.0cm

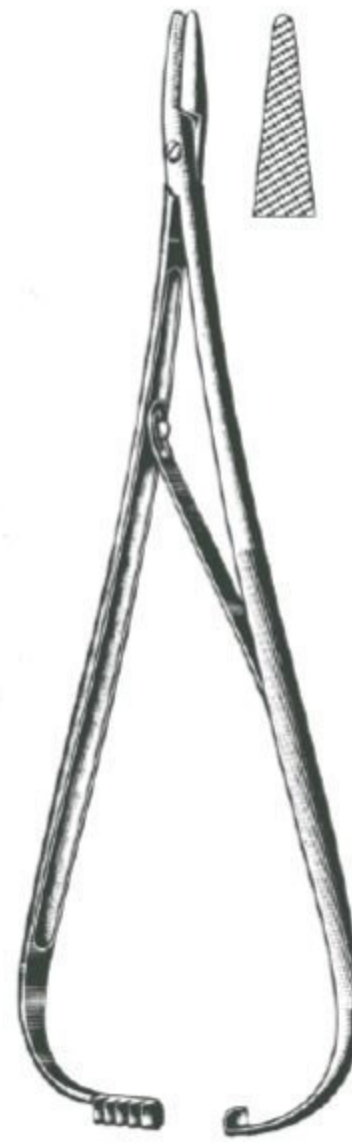

Lichtenberg
 09-2544-20 20.0cm

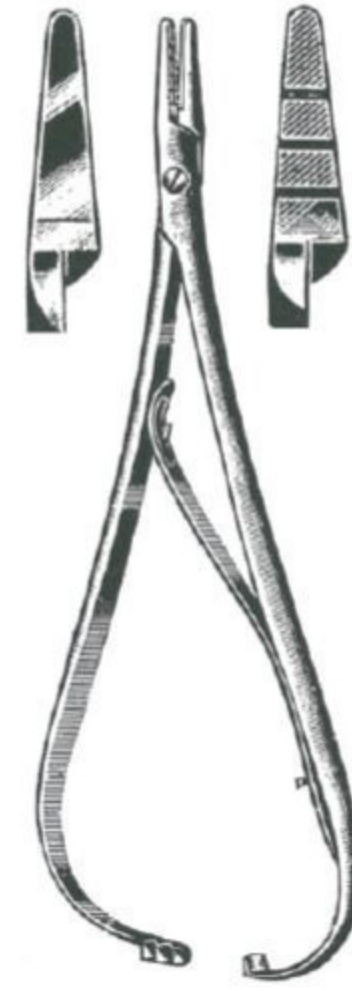

Macphail
 09-2545-14 14.0cm
 09-2545-16 16.0cm
 09-2545-18 18.0cm
 09-2545-20 20.0cm



Mathieu
 09-2546-14 14.0cm 09-2547-14
 09-2546-17 17.0cm 09-2547-17
 09-2546-20 20.0cm 09-2547-20
 09-2546-24 24.0cm 09-2547-24



Mathieu
 09-2548-14 14.0cm
 09-2548-17 17.0cm



Mathieu
 09-2549-17 17.0cm
 09-2549-20 20.0cm



Straight
09-2550-14



Curved
09-2551-14

Castroviejo
14cm/5 1/2"



Straight
09-2552-14
09-2552-18



Curved
09-2553-14
09-2553-18

Castroviejo



Straight
09-2554-09



Curved
09-2554-09A

Castroviejo
9cm/3 1/2"

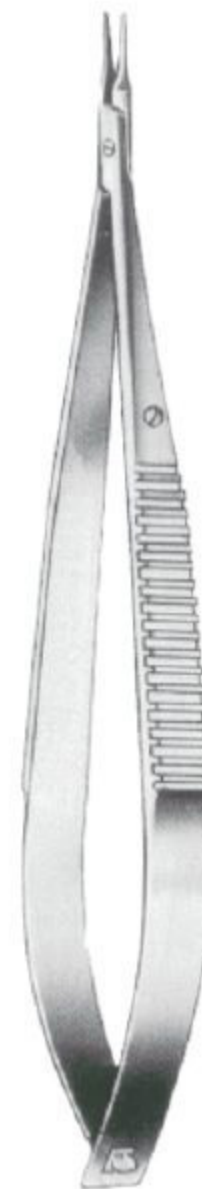

Straight
09-2555-14



Curved
09-2555-14A

Castroviejo
14cm/5 1/2"

Micro Needle Holders ● EN

Mikro Nadelhalter ● DE

Micro-porta-agujas ● ES



Castroviejo
9 cm/3 1/2"



Straight
09-2556-09



Curved
09-2557-09

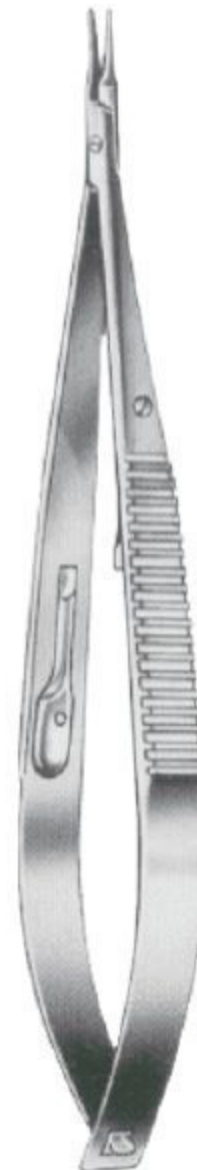

Castroviejo
14 cm/5 1/2"



Straight
09-2558-14



Curved
09-2559-14



Paton
09-2560-11
11.5 cm/4 1/2"



Jacobson

cm	in	Without ratchet	With ratchet
18	7"	09-2561-18	09-2562-18
21	8 1/4"	09-2561-21	09-2562-21



Straight
 09-2563-15
 15 cm/6"



Curved
 09-2564-15
 15 cm/6"

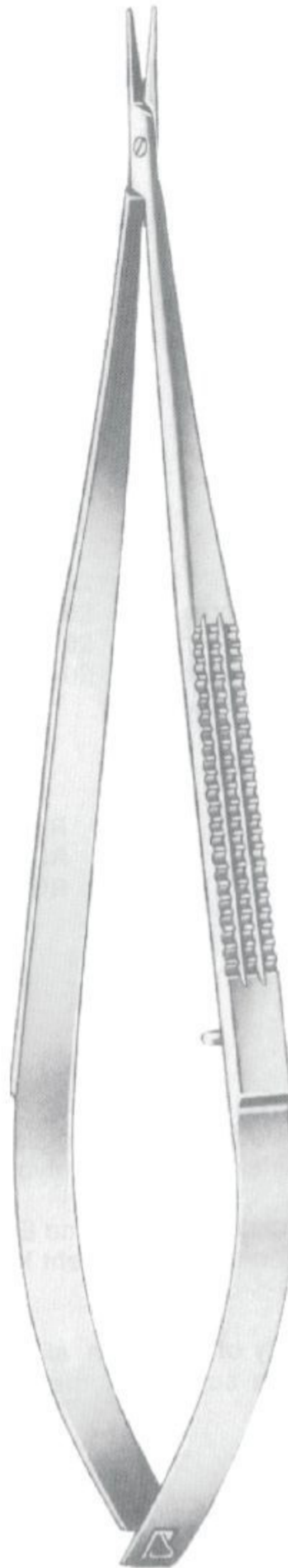

Straight
 09-2565-18
 18 cm/7"

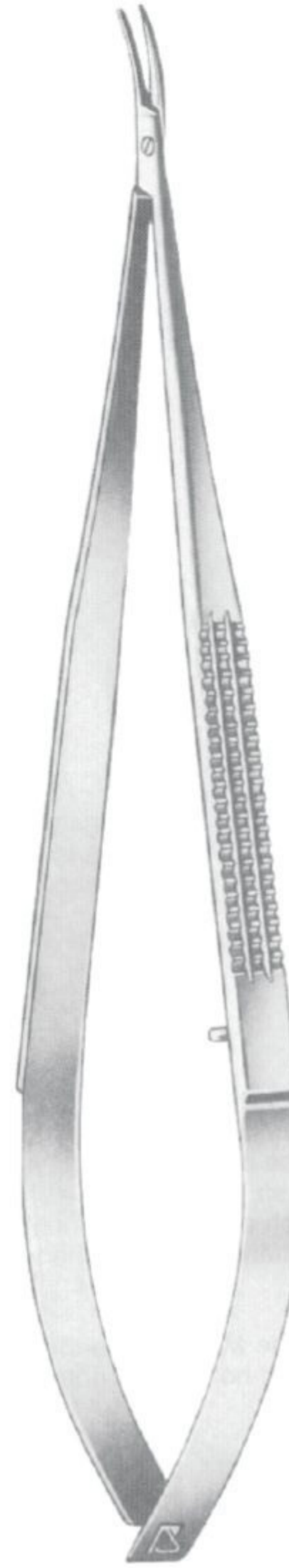

Curved
 09-2566-18
 18 cm/7"



Straight
 09-2567-18
 18 cm/7"

Micro Needle Holders ● EN
 Mikro Nadelhalter ● DE
 Micro-porta-agujas ● ES

Straight



09-2568-18
 09-2568-22

Curved



09-2569-18
 09-2569-22

Yasargil
 18.0 cm/7"
 22.5 cm/8¾"



Straight
09-2570-15
15 cm/6"



Curved
09-2571-15
15 cm/6"



Straight
09-2572-15
15 cm/6"



Curved
09-2573-15
15 cm/6"

- Micro Needle Holders ● EN
- Mikro Nadelhalter ● DE
- Micro-porta-agujas ● ES



Straight
 09-2574-18
 18.5 cm/7¼"



Curved
 09-2575-18
 18.5 cm/7¼"



Straight
 09-2576-18
 18.5 cm/7¼"



Curved
 09-2577-18
 18.5 cm/7¼"



23 cm/9"





Straight
 09-2580-12
 12 cm/4¾"



Curved
 09-2581-12
 12 cm/4¾"



Angled
 09-2582-12
 12 cm/4¾"



Straight
 09-2583-12
 12 cm/4¾"



Curved
 09-2584-12
 12 cm/4¾"



Angled
 09-2585-12
 12 cm/4¾"

- Micro Needle Holders ● — EN
- Mikro Nadelhalter ● — DE
- Micro-porta-agujas ● — ES



Arruga
 14 cm/5½"

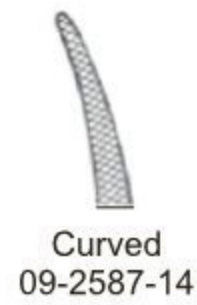
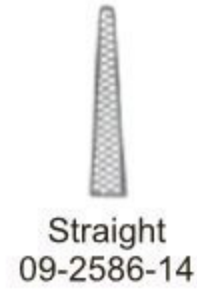

Stevens
 09-2588-13 13 cm/5"
 09-2588-15 15 cm/6"



Kalt
 09-2589-14
 14 cm/5½"



Castroviejo-Kalt
 09-2590-13
 13.5 cm/5¼"



Kalt-Arruga
 09-2591-14
 14 cm/5½"

Left



20 cm/8"



09-2592-01



Blunt



09-2593-02



09-2594-01



Sharp



09-2595-02

Deschamps-Standard

Right



20 cm/8"



20 cm/8"



09-2596-01



Blunt



09-2597-02



09-2598-01



Sharp



09-2599-02

Deschamps



20 cm/8"

Ligature Needles ●— EN
 Unterbindungsnadeln ●— DE
 Aguja para ligaduras ●— ES

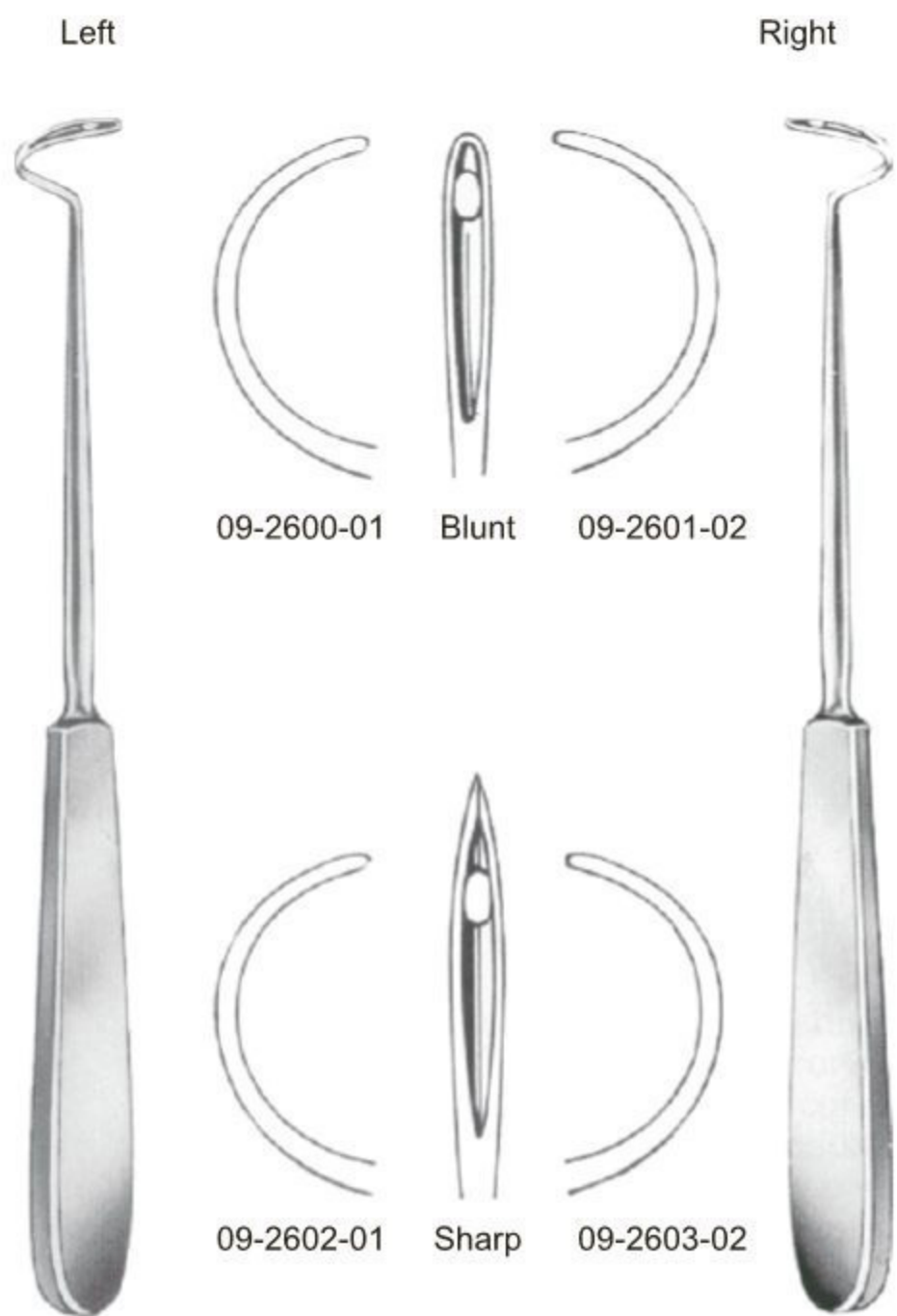
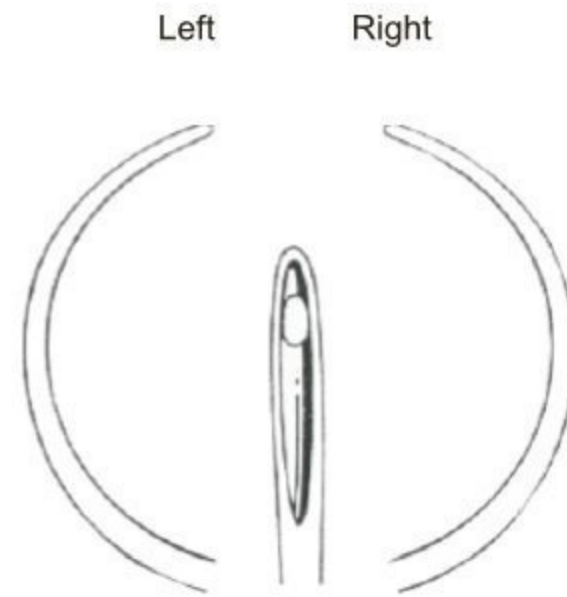

09-2600-01 Blunt 09-2601-02

09-2602-01 Sharp 09-2603-02



21cm/8¼"

Deschamps

21 cm/8¼"

Deschamps
 24 cm/9½"
 09-2604-01 09-2605-02

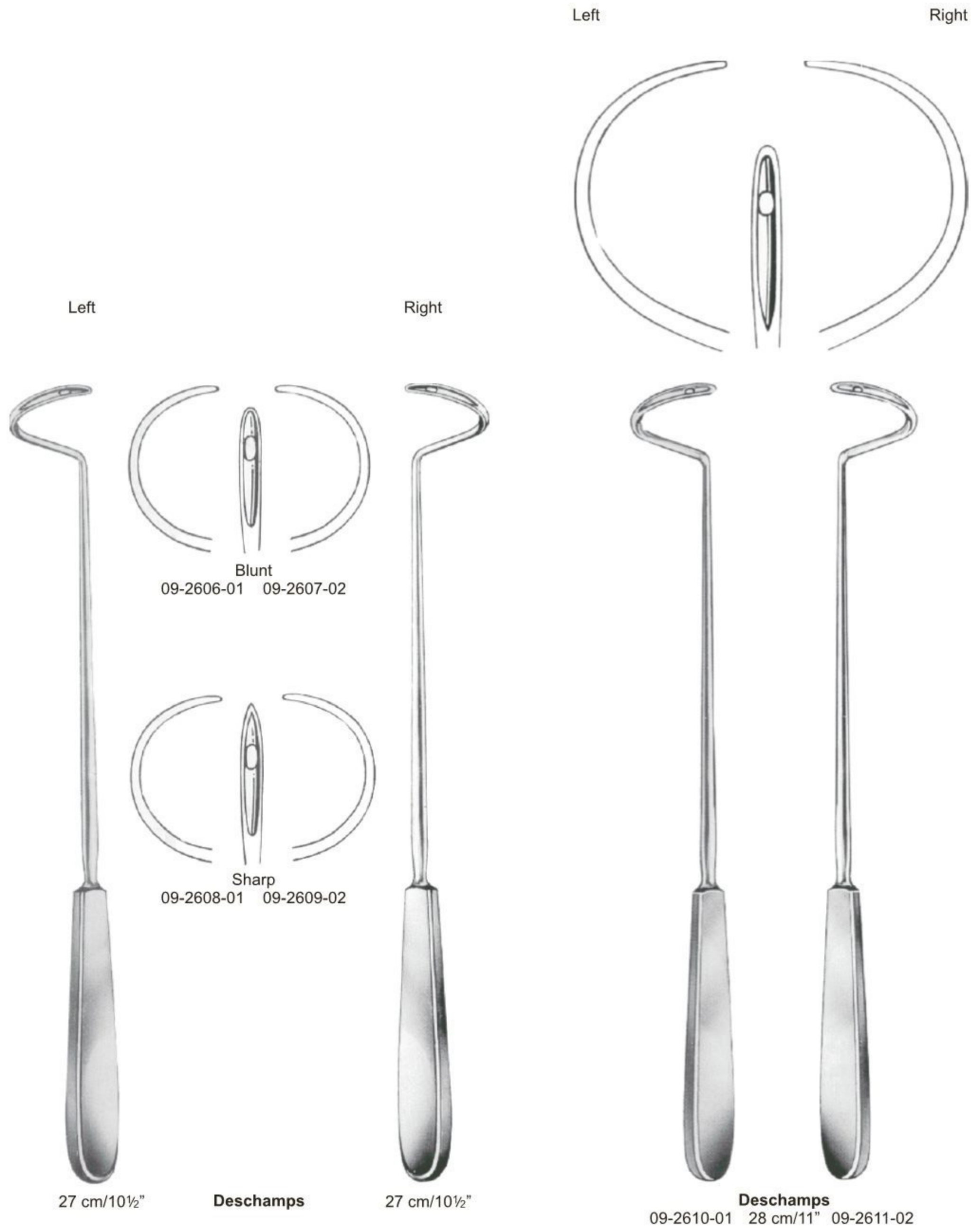

Ligature Needles ● EN
 Unterbindungsnadeln ● DE
 Agujas para ligaduras ● ES



09-2612-01 09-2613-02 09-2614-03

Kocher
 19 cm/7½"



Kronecker
 09-2615-01 13 cm/5" 09-2616-02



Dupuy-Weiss
 09-2617-01 22 cm/8¾" 09-2618-02



Durham
 09-2619-01 21 cm/8¼" 09-2620-02

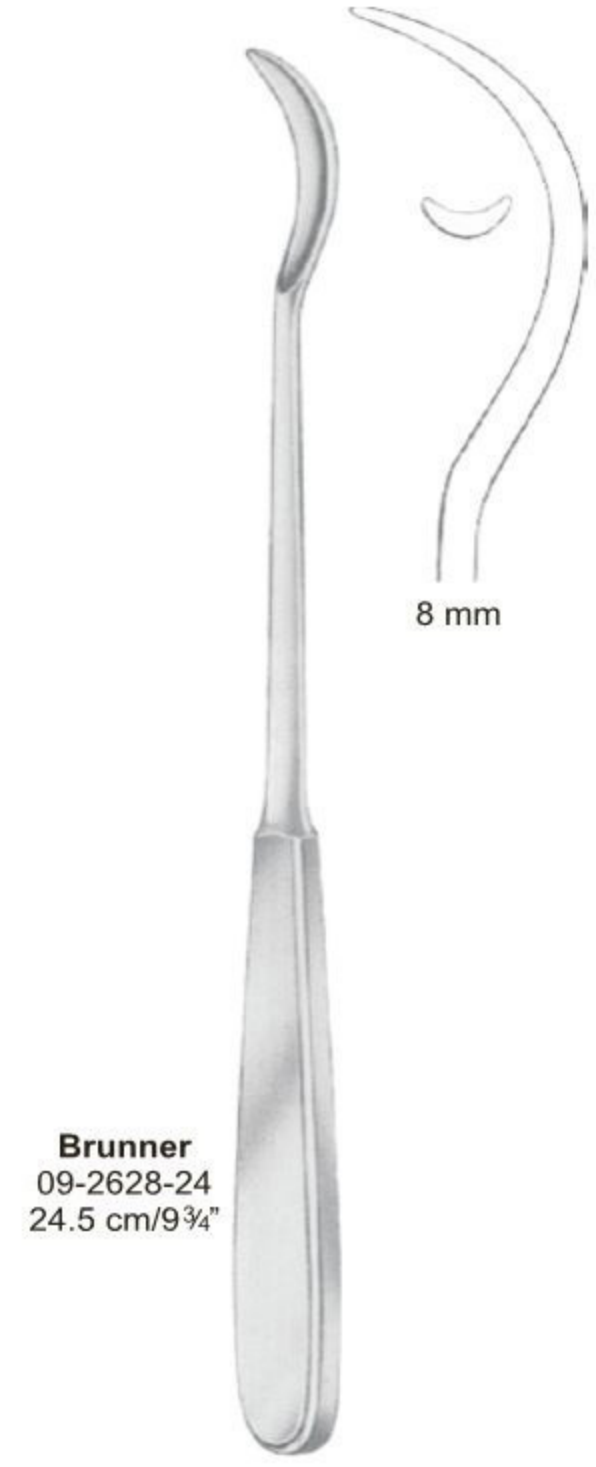
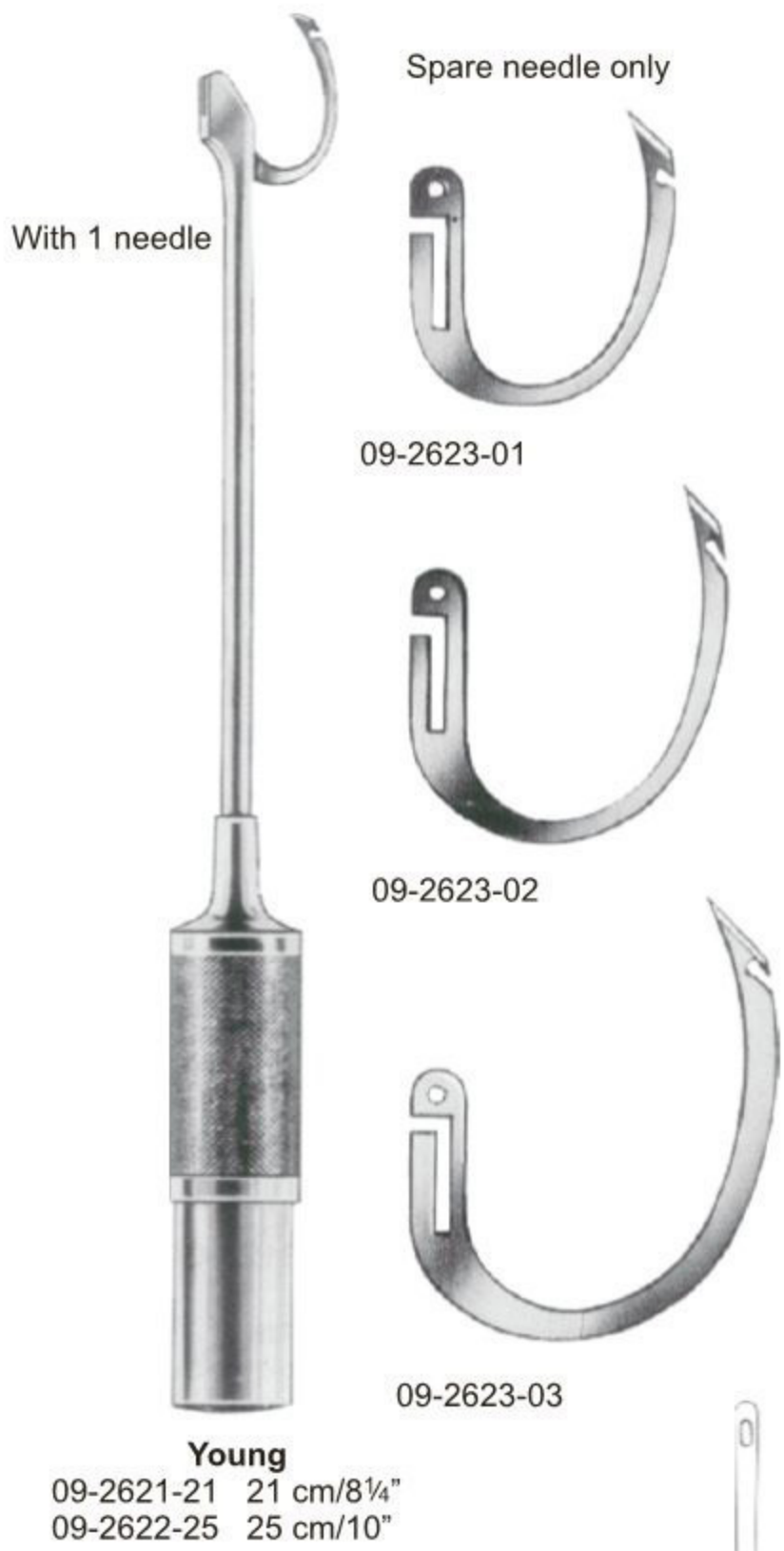

Reverdin Needles ● EN
 Reverdin Nadeln ● DE
 Aguja de Reverdin ● ES



Reverdin
 19.5 cm/7¾"



Fig. 1
 09-2629-01



Fig. 2
 09-2629-02



Fig. 3
 09-2629-03



Fig. 4
 09-2629-04



Reverdin
 22.5 cm/8¾"



Fig. 1
 09-2630-01



Fig. 2
 09-2630-02



Fig. 3
 09-2630-03



Fig. 4
 09-2630-04



Castroviejo

14cm/5½"
 18cm/7"
 21cm/8¼"



09-2631-14
 09-2631-18
 09-2631-21

Smooth



09-2632-14
 09-2632-18
 09-2632-21



14cm/5½"
 18cm/7"
 21cm/8¼"

09-2633-14
 09-2633-18
 09-2633-21



09-2634-14
 09-2634-18
 09-2634-21



Kalt
 14cm/5½"



09-2635-14



09-2636-14



Barraquer
 09-2637-14
 14cm/5 ½"



Castroviejo
 09-2638-13
 13cm/5"



09-2639-18



09-2640-18

Smooth



Hepp-Schiedel
 18cm/7"

Needle Holders ● EN
 Nadelhalter ● DE
 Porta-agujas ● ES



Arruga
 14cm/5½"

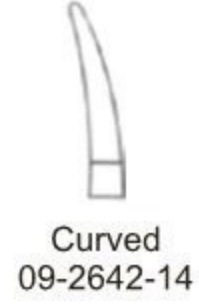

Jacobson
 09-2643-18 18cm/7"
 09-2643-20 20cm/8"
 09-2643-23 23cm/8¾"



Diethrich

Straight		Curved
09-2644-16	16cm/6¼"	09-2645-16
09-2644-18	18cm/7"	09-2645-18
09-2644-20	20cm/8"	09-2645-20
09-2644-23	23cm/9"	09-2645-23
09-2644-25	25cm/10"	09-2645-25

Two rings angled



Neivert
 09-2646-13
 13 cm/5"



Neivert
 09-2647-13
 13 cm/5"

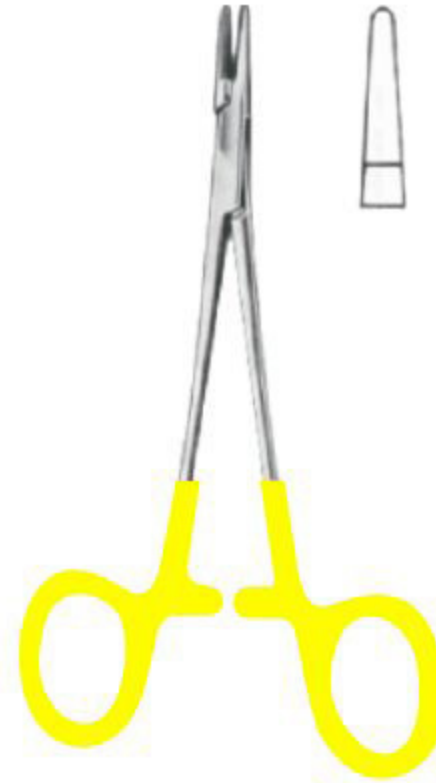

Webster
 09-2648-13
 13 cm/5"



Derf
 09-2649-12
 12.5 cm/5"



New Orleans
 09-2650-18
 18 cm/7"



Bozemann
 09-2651-20 20 cm/8"
 09-2651-24 24 cm/9½"
 09-2651-26 26 cm/10½"

Needle Holders ● EN
 Nadelhalter ● DE
 Porta-agujas ● ES



Mayo-Hegar

09-2652-16
 09-2652-18
 09-2652-20
 09-2652-24
 09-2652-26
 09-2652-30



09-2653-20
 09-2653-24
 09-2653-26

16cm/6¼"
 18cm/7"
 20cm/8"
 24cm/9½"
 26cm/10½"
 30cm/12"

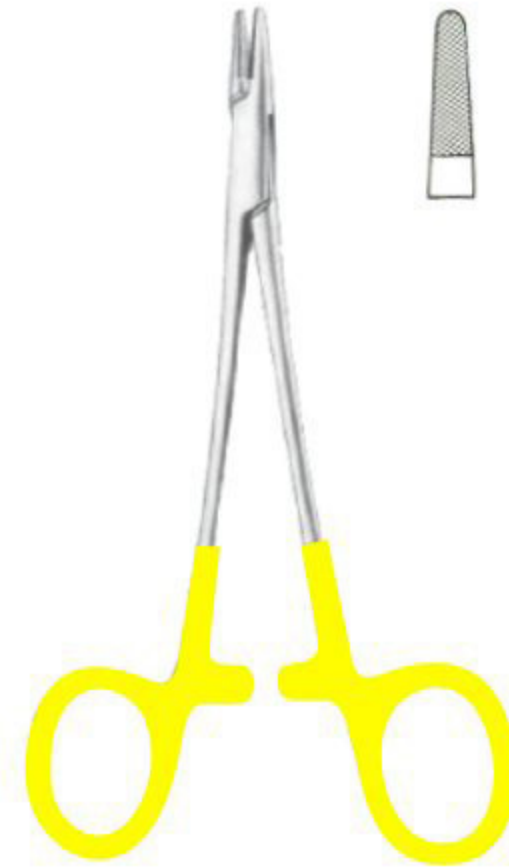

Hegar-Baumgartner
 09-2654-14
 14cm/5½"



Mayo-Hegar
 09-2655-20 20cm/8"
 09-2655-24 24cm/9½"

Heavy Pattern



De Bakey
 09-2656-18
 09-2656-20
 09-2656-23
 09-2656-26
 09-2656-31



18cm/7"
 20cm/8"
 23cm/9"
 26cm/10¼"
 31cm/12¼"



De Bakey-Fine
 09-2657-18
 09-2657-20
 09-2657-23
 09-2657-26
 09-2657-31



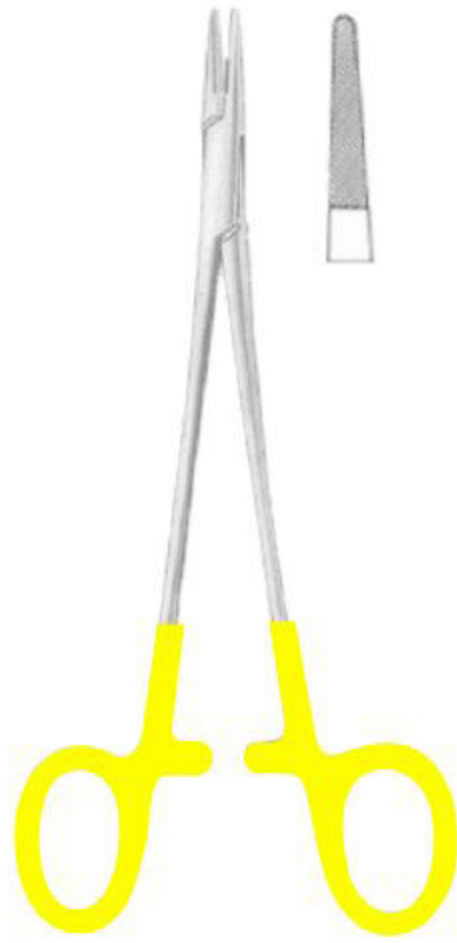

Baby-Crile-Wood
 09-2658-15
 15cm/6"

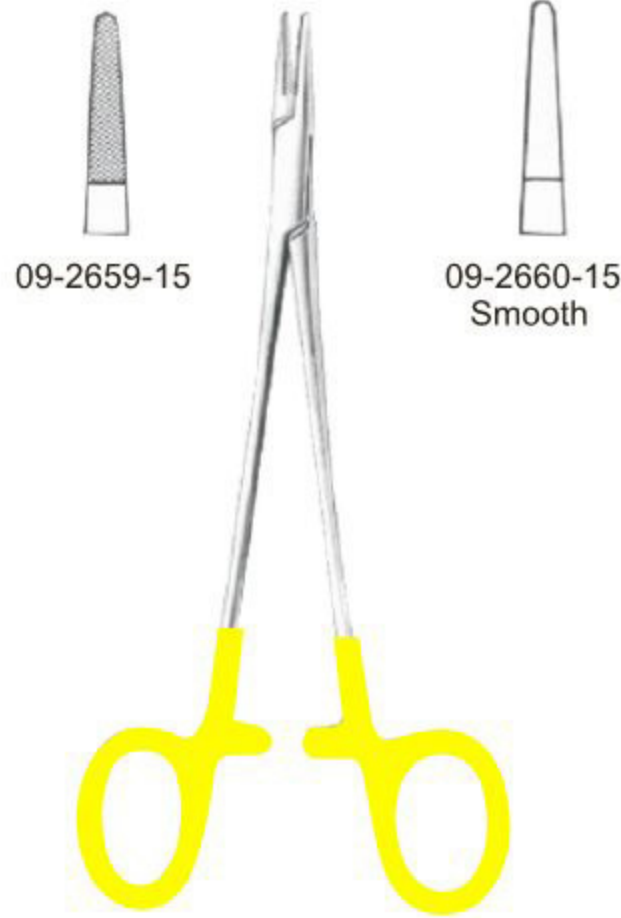

Crile-Wood
 15cm/6"



Crile-Wood

	cm	in
09-2661-18	18	7"
09-2661-20	20	8"
09-2661-23	23	9"
09-2661-26	26	10 1/4"
09-2661-31	31	12 1/4"

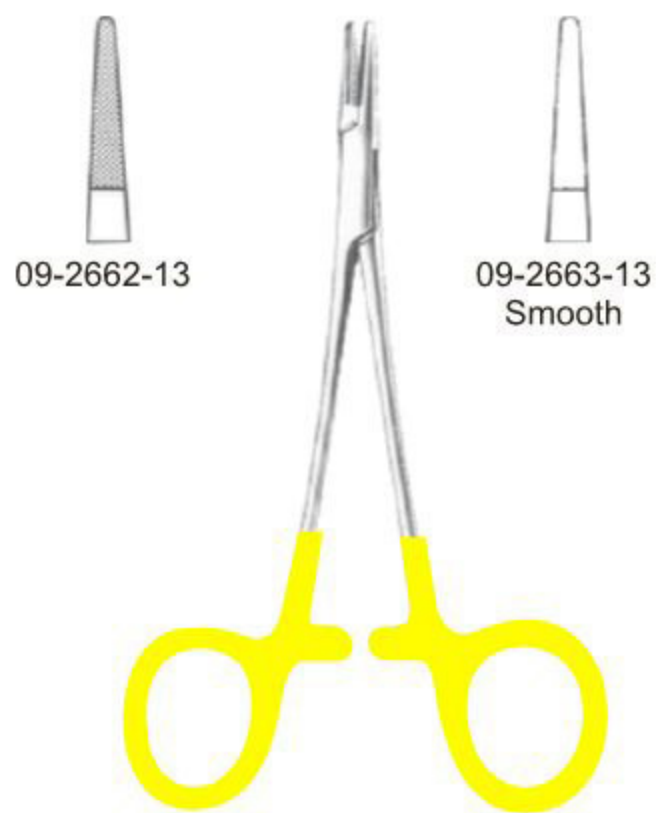

Halsey
 13cm/5"

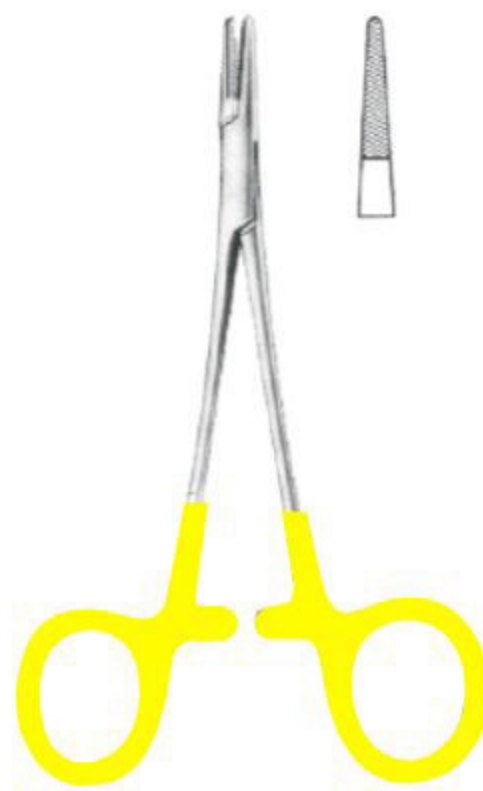

Converse
 09-2664-12
 12.5cm/5"

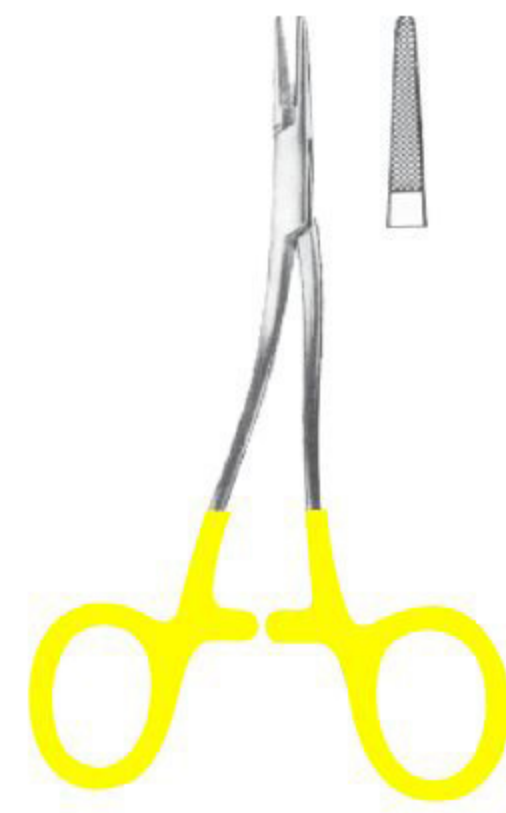

Kilner
 09-2665-13
 13.5cm/5 1/4"

Needle Holders ● EN
 Nadelhalter ● DE
 Porta-agujas ● ES



Hegar-Vascular
 09-2666-14 14cm/5½"
 09-2666-18 18cm/7"
 09-2666-20 20cm/8"
 09-2666-23 23cm/9"



Ryder		Micro-Ryder	
09-2667-13		09-2668-13	13cm/5"
09-2667-15		09-2668-15	15cm/6"
09-2667-18		09-2668-18	18cm/7"
09-2667-20		09-2668-20	20cm/8"
09-2667-23		09-2668-23	23cm/9"
09-2667-26		09-2668-26	26cm/10¼"



(Swedish Pattern)
 09-2669-15 15cm/6"
 09-2669-17 17cm/6¾"
 09-2669-20 20cm/8"



Sarot
 09-2670-18 18cm/7"
 09-2670-26 26cm/10¼"

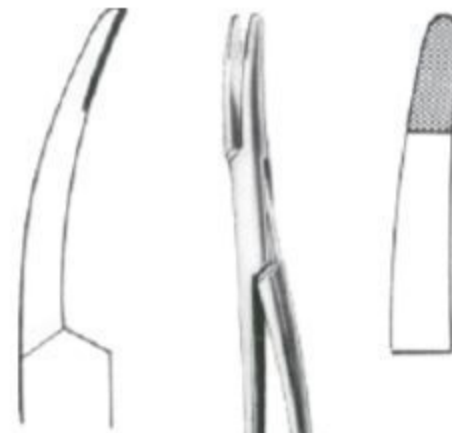

Stratte
 09-2671-23
 23cm/9"



Masson
 09-2672-27
 27cm/10½"



Wangenstein
 09-2673-27
 27cm/10½"



Finocchetto
 09-2674-20 20cm/8"
 09-2674-27 27cm/10½"

Needle Holders ● EN
 Nadelhalter ● DE
 Porta-agujas ● ES

**Mathieu**

14cm/5½"	09-2675-14
17cm/6¾"	09-2675-17
20cm/8"	09-2675-20
24cm/9½"	09-2675-24

**Mathieu**

09-2676-14
09-2676-17
09-2676-20
09-2676-24

**Mathieu-Ryder**

09-2677-17
09-2677-20

**Langenbeck**

16cm/6¼"	09-2678-16
18cm/7"	09-2678-18
20cm/8"	09-2678-20

**Langenbeck-Ryder**

09-2679-18
09-2679-20

**Lichtenberg**

09-2680-20



Toennis
 09-2681-18
 18 cm/7"



Mathieu-Kocher
 09-2682-14 14 cm/5 1/2"
 09-2682-17 17 cm/6 3/4"
 09-2682-20 20 cm/8"



Axhausen
 09-2683-18
 18.5 cm/7 1/4"



Zweifel
 09-2684-20 20 cm/8"
 09-2684-23 23 cm/9"

Needle Holders ● EN
 Nadelhalter ● DE
 Porta-agujas ● ES



09-2685-20 20 cm/8"
 09-2685-25 25 cm/10"



Heavy Pattern

Mathieu
 09-2686-20 20 cm/8"
 09-2686-24 24 cm/9½"



Metzenbaum
 09-2687-17 17 cm/6¾"
 09-2687-20 20 cm/8"



09-2688-16



09-2689-16

Arruga
 16 cm/6¼"



Boynton
 09-2690-12 12 cm/4¾"



Hosel
 09-2691-20 20 cm/8"
 09-2691-25 25 cm/10"

Needle Holders ● EN
 Nadelhalter ● DE
 Porta-agujas ● ES



Baby-Olsen-Hegar
 09-2692-11
 11.5 cm/4½"



Olsen-Hegar
 09-2693-14
 14 cm/5½"



Olsen-Hegar
 09-2694-17
 17 cm/6¾"



Olsen-Hegar
 09-2695-18
 18 cm/7"



Gillies-Slim
 09-2696-14
 14.5 cm/5½"

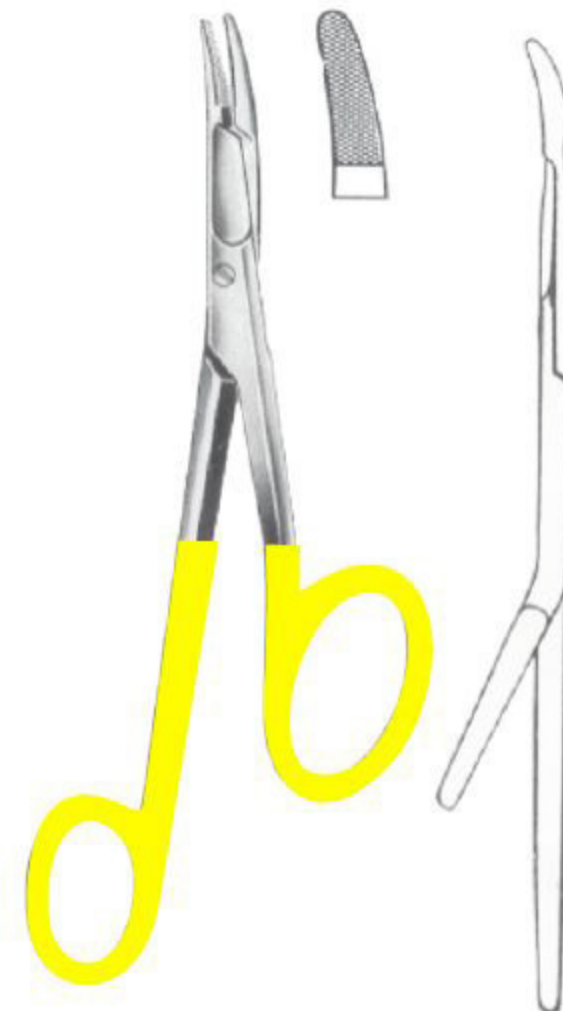

Gillies
 09-2697-16 (right hand)
 09-2698-16 (left hand)
 16 cm/6¼"

- EN** Probes, Applicators, Spatulas
DE Sonden, Watteträger, Spatel
ES Sondas, Porta-algodones, Espátulas

Page 176 to 181





cm	In	1.0 mmØ	1.5 mmØ	2.0 mmØ	2.0 mmØ	Watson-Cheyne	Fish
11.5	4 1/2"	10-2851-11	10-2852-11	10-2853-11		10-2855-11	
13	5"	10-2851-13	10-2852-13	10-2853-13		10-2855-13	
14.5	5 3/4"	10-2851-14	10-2852-14	10-2853-14	10-2854-14	10-2855-14	10-2857-14
16	6 1/4"	10-2851-16	10-2852-16	10-2853-16	10-2854-16	10-2855-16	
18	7"	10-2851-18	10-2852-18	10-2853-18		10-2855-18	10-2857-18
20	8"	10-2851-20	10-2852-20	10-2853-20		10-2855-20	
25	10"	10-2851-25	10-2852-25	10-2853-25			



cm	In			Nelaton	Stacke 1.0 mm Ø	Brodie
10.5	4 1/4"				10-2863-10	
11.5	4 1/2"	10-2858-11		10-2860-13		
13	5"	10-2858-13		10-2860-14		
14.5	5 3/4"	10-2858-14	10-2859-14	10-2860-16		
16	6 1/4"	10-2858-16		10-2860-18		10-2864-16
18	7"	10-2858-18				
20	8"	10-2858-20				

Probes, Plaster Spatulas, Cotton Applicators, Fistula Probes ●— EN

Sonden, Watterträger ●— DE

Estiletes, Porta- algodones ●— ES



Of tin

- 10-2865-25 25 cm/10"
- 10-2865-30 30 cm/12"
- 10-2865-40 40 cm/15¾"

Plaster spatulas



- 10-2866-13 13 cm/5"
- 10-2866-14 14 cm/5½"

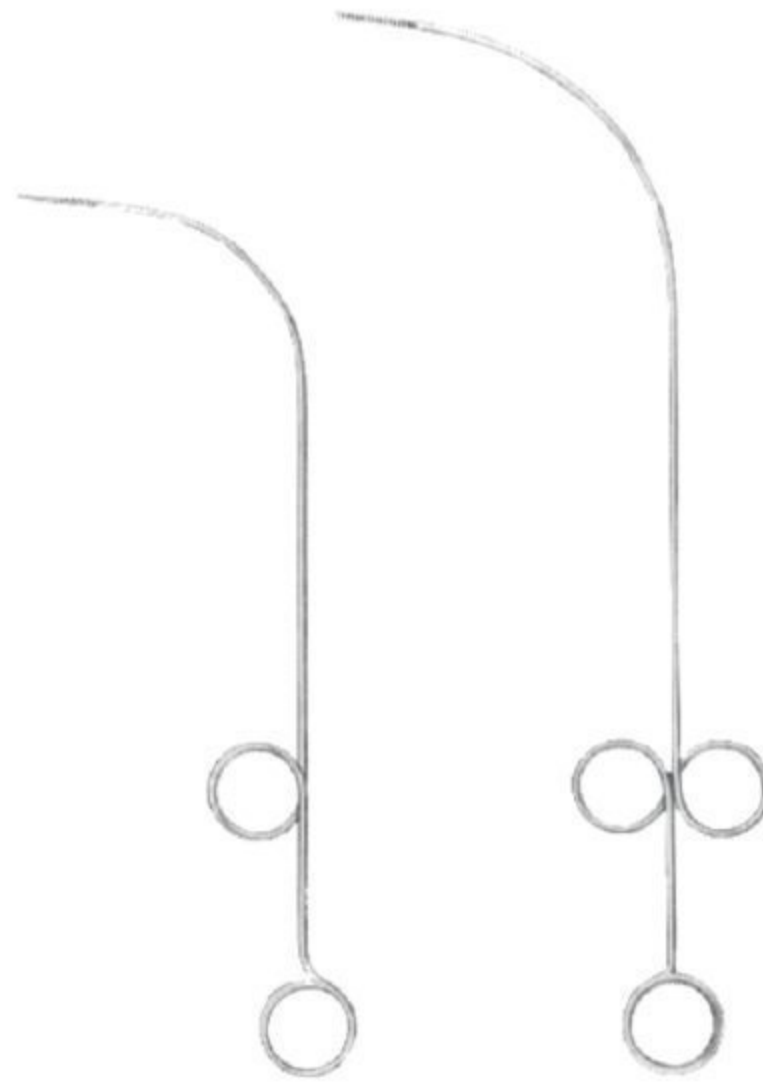

Pelteson
10-2867-23
23 cm/9"

Fein
10-2868-28
28 cm/11"



Buie
10-2869-16
16 cm/6¼"

Fistula probes



Lockhart-Mummary
16.5 cm/6½"



Fig. 1
10-2870-01



Fig. 2
10-2870-02



Fig. 3
10-2870-03



Fig. 4
10-2870-04



Pratt
21 cm/8¼"



10-2871-01



10-2871-02



10-2871-03



Universal

cm	in	1.2 mm Ø	1.5 mm Ø	1.7 mm Ø
12.5	5"	10-2872-12		
16	6¼"	10-2872-16		
18	7"	10-2872-18	10-2873-18	10-2874-18



Uckermann
 10-2875-16
 16 cm/6¼"



Jobson-Horne
 10-2876-13 13 cm/5"
 10-2876-18 18 cm/7"



Round Triangular

Farrell
 (Farrell-Lathbury)

cm	in		●	▲
12	4¾"			
14	5½"	0.9 mm Ø	10-2877-14	10-2878-14
16	6¼"	1.1 mm Ø	10-2877-16	10-2878-16
18	7"			



Round Triangular

●	●	▲
1.2 mm Ø	1.5 mm Ø	1.5 mm Ø
10-2879-12	10-2880-12	10-2881-12
10-2879-14	10-2880-14	10-2881-14
10-2879-16	10-2880-16	10-2881-16
10-2879-18	10-2880-18	10-2881-18

Cotton Applicators ● EN
 Watteträger ● DE
 Porta-algodones ● ES

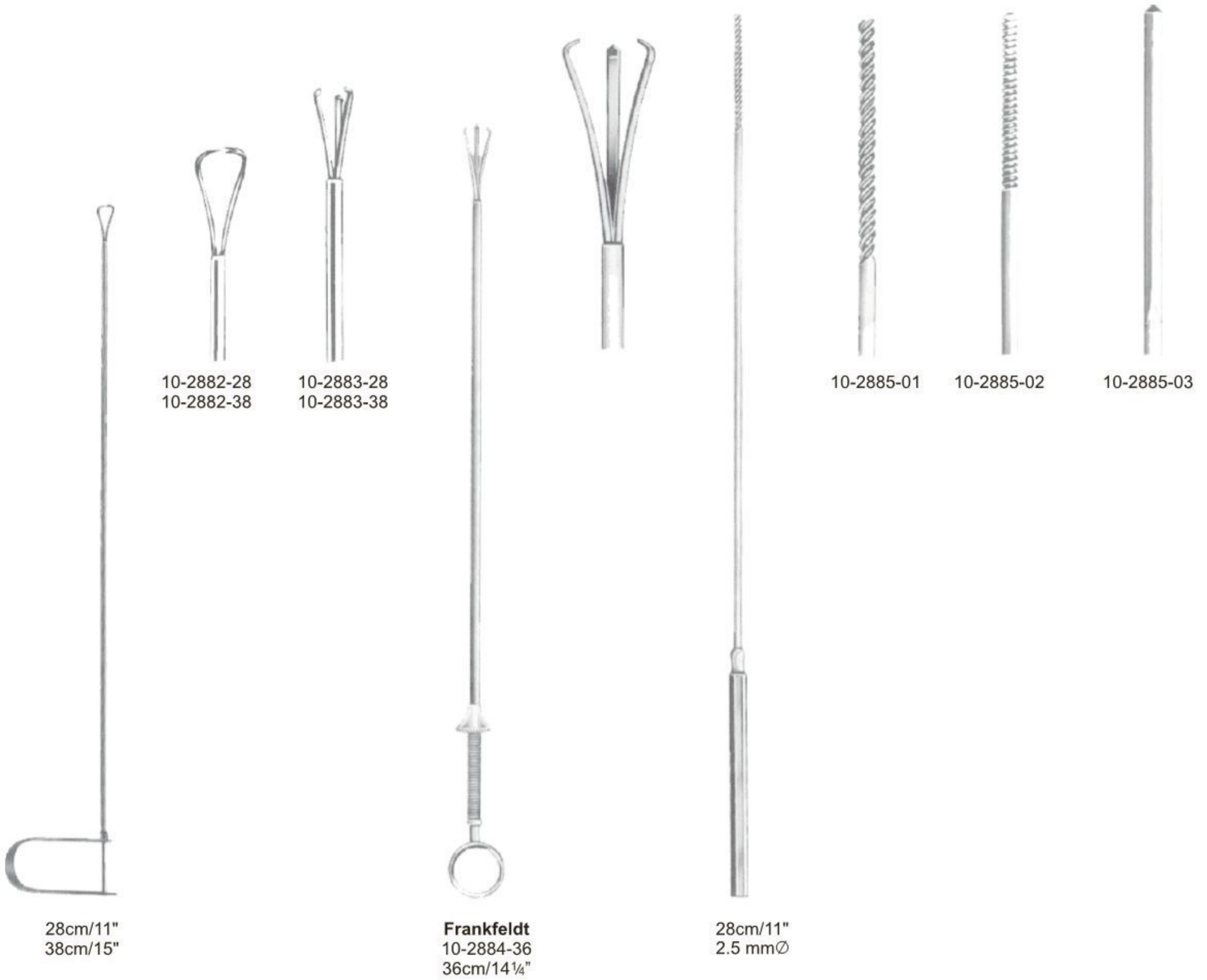

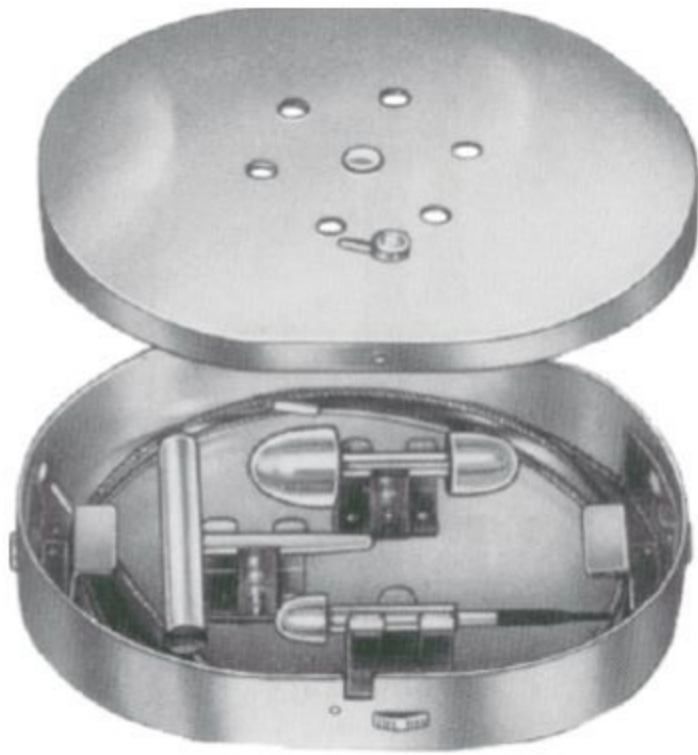

Nabatoff
 10-2886-00
 135x100x25 mm

Sterilizable

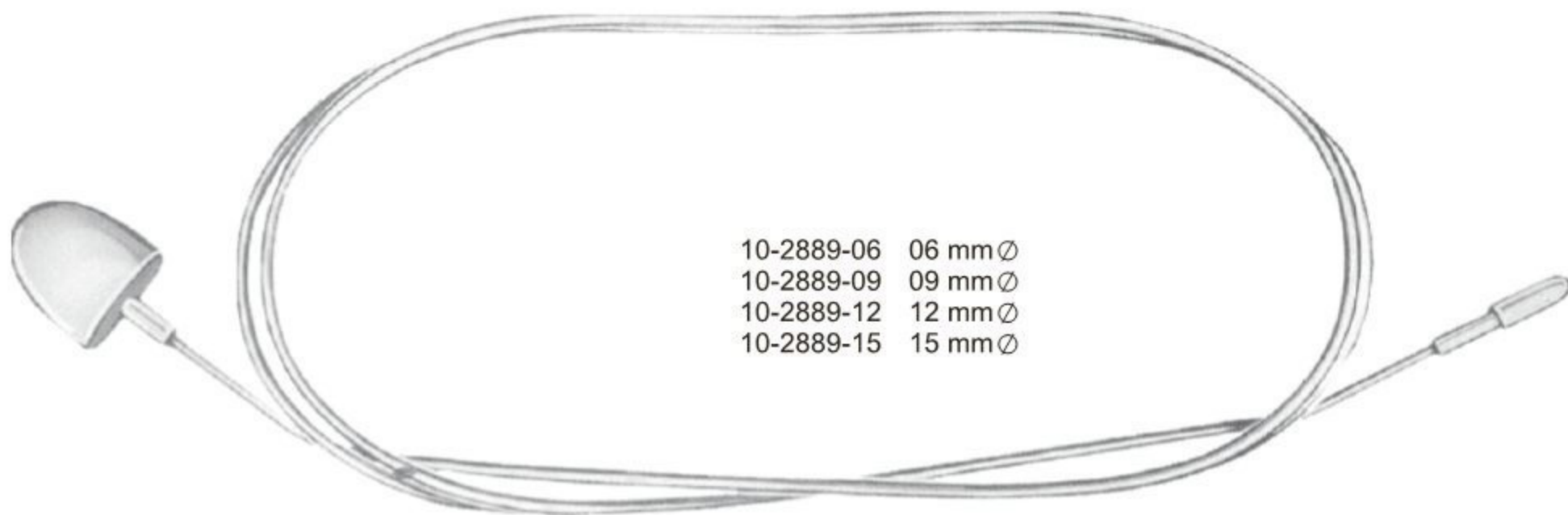
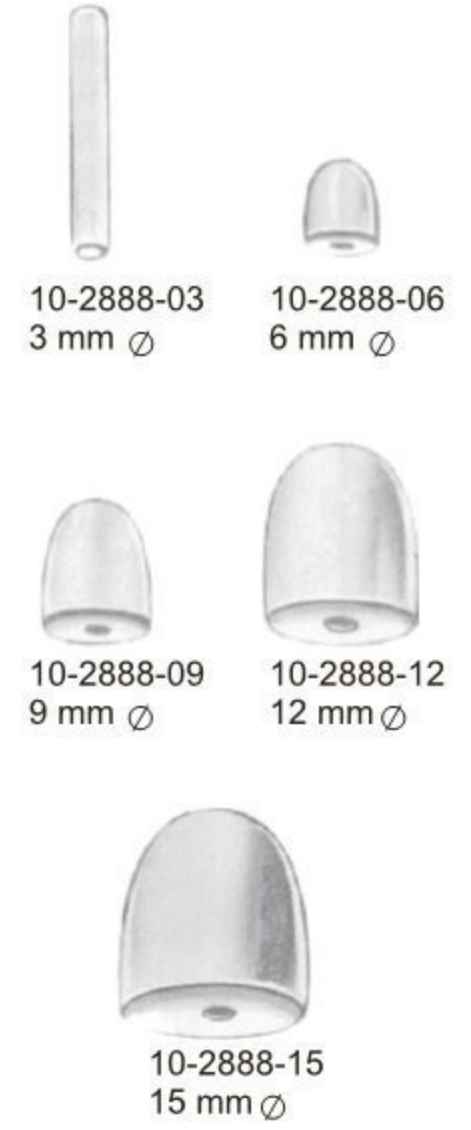
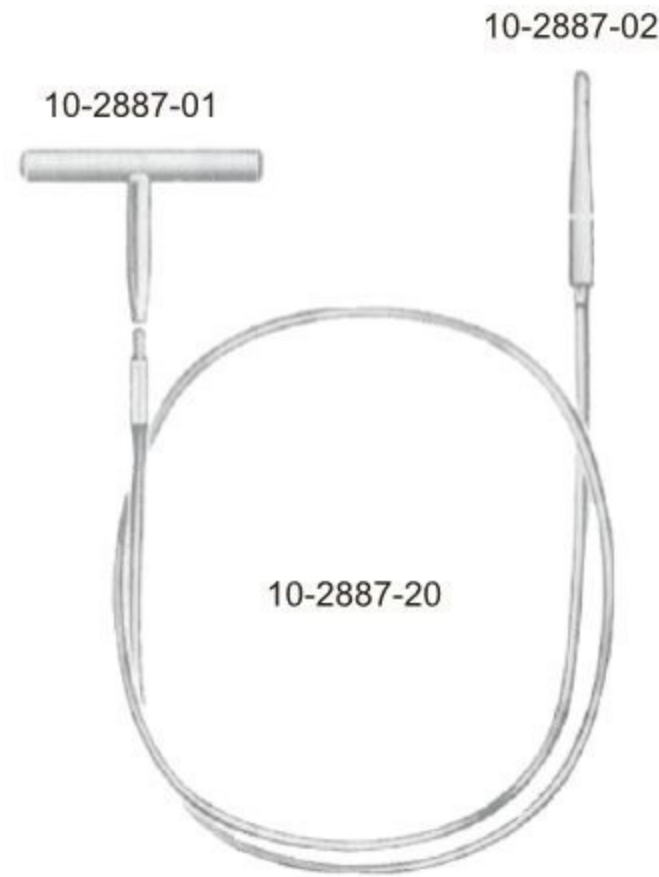

10-2889-06 06 mm Ø
 10-2889-09 09 mm Ø
 10-2889-12 12 mm Ø
 10-2889-15 15 mm Ø

Myers

Strippers



55cm/21½"

	mm Ø
10-2890-02	2.0
10-2890-03	3.0
10-2890-04	4.0
10-2890-06	6.0
10-2890-07	7.0
10-2890-08	8.5
10-2890-10	10.0
10-2890-12	12.0
10-2890-14	14.0



Handle for
10-2890-00

Probes for Varicose Veins



Babcock

Malleable

cm	in	
40	13½"	10-2891-40
50	20"	10-2891-50
65	26"	10-2891-65
80	32"	10-2891-80

Vessel Irrigating Cannulas



Schimd



10-2892-03
3 mm Ø



10-2892-04
4 mm Ø



10-2892-05
5 mm Ø



10-2892-06
6 mm Ø

Spatulas



3 mm
Blunt

10-2893-18 18.0 cm/7"
10-2893-21 21.5 cm/8½"



Schmid



10-2894-14
14 cm/5½"
5 mm



10-2894-24
24 cm/9¼"
7 mm

- EN** Retractors
- DE** Wundhaken und -sperrer
- ES** Separadores

Page 182 to 241







11-3011-16
 16cm/6¼"

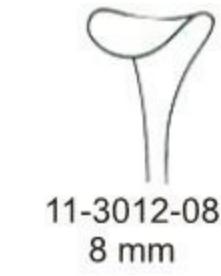

11-3012-08
 8 mm



11-3012-10
 10 mm



11-3013-12
 12 mm



11-3013-14
 14 mm



11-3012-12
 12 mm

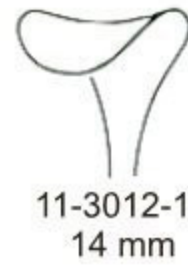

11-3012-14
 14 mm



11-3013-16
 16 mm



11-3013-18
 18 mm

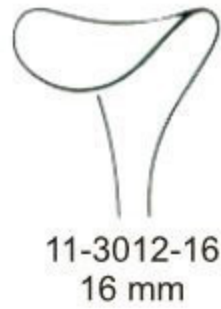

11-3012-16
 16 mm

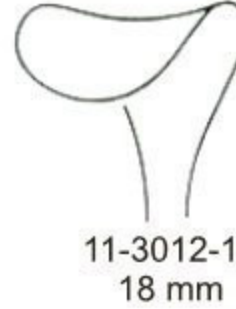

11-3012-18
 18 mm



11-3014-16
Graefe
 16cm/6¼"

Sharp



11-3015-16

Blunt



11-3016-16
 16cm/6¼"



11-3017-16
 16cm/6¼"



11-3018-16
O, Connor
 16cm/6¼"



11-3019-16
Guthrie
 16cm/6¼"



11-3020-16



11-3021-16
 16cm/6¼"



11-3022-16
 16cm/6¼"

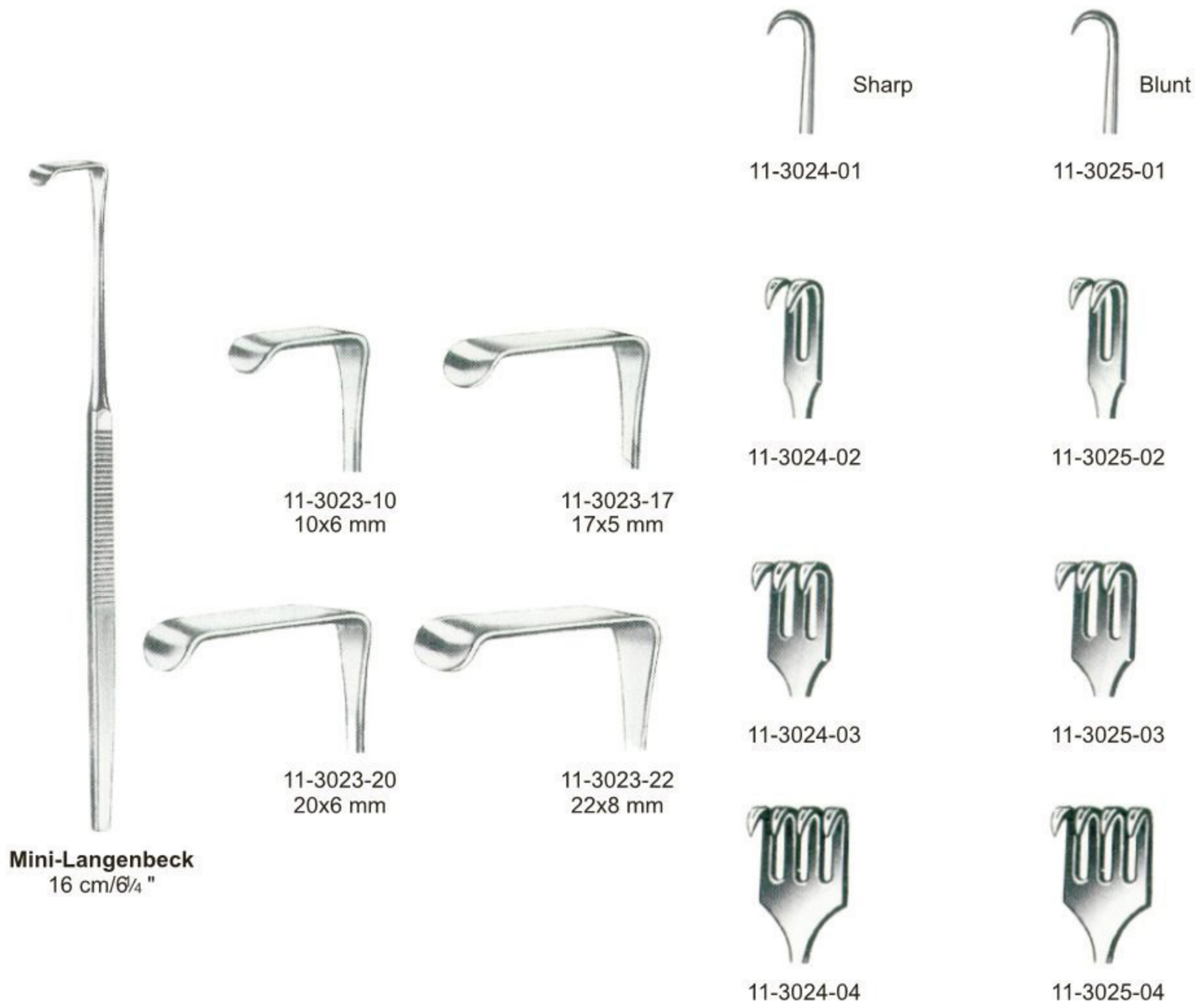

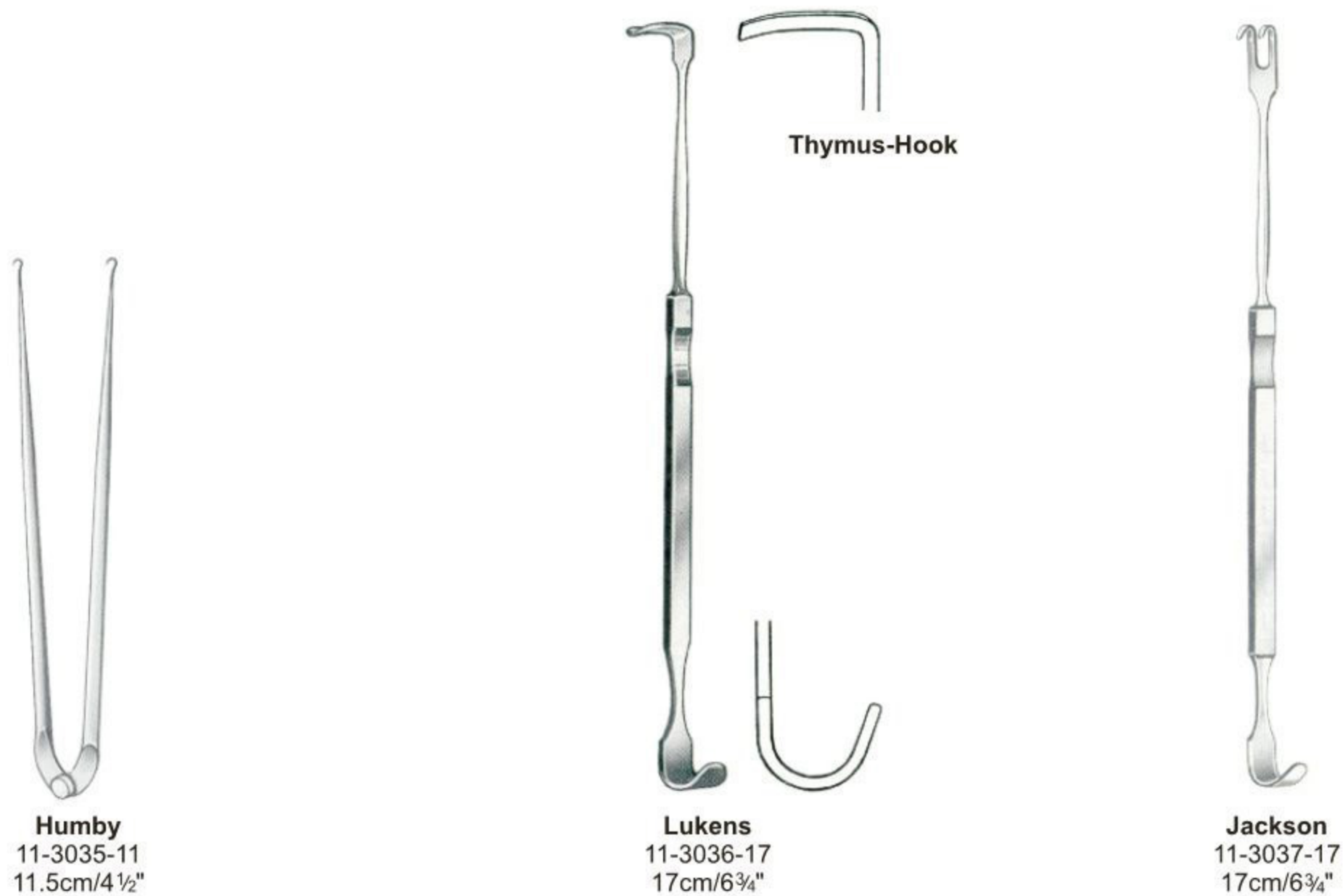

Malleable



Gil-Vernet
 24cm/9½"

08 mm 11-3038-08	11-3039-08
11 mm 11-3038-11	11-3039-11
15 mm 11-3038-15	11-3039-15
17 mm 11-3038-17	11-3039-17
20 mm 11-3038-20	11-3039-20
23 mm 11-3038-23	11-3039-23

Malleable



24cm/9½"

12x14 mm



Little
 11-3040-20
 20cm/8"



Love-(Morse)
 25cm/10"

10 mm 11-3041-10
 15 mm 11-3041-15
 20 mm 11-3041-20
 30 mm 11-3041-30
 40 mm 11-3041-40
 50 mm 11-3041-50

Retractors ● EN
 Wundhaken ● DE
 Separadores ● ES

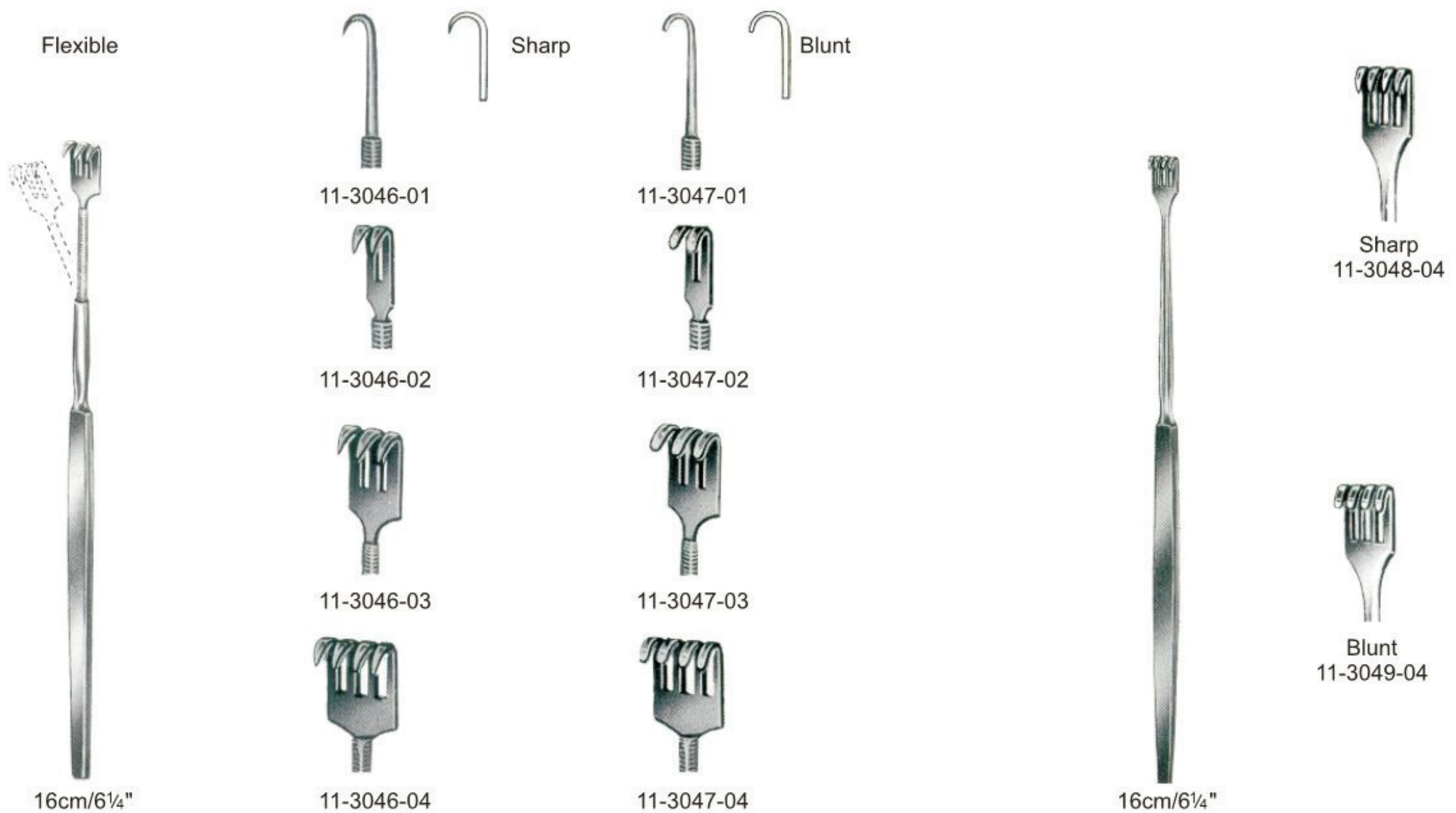
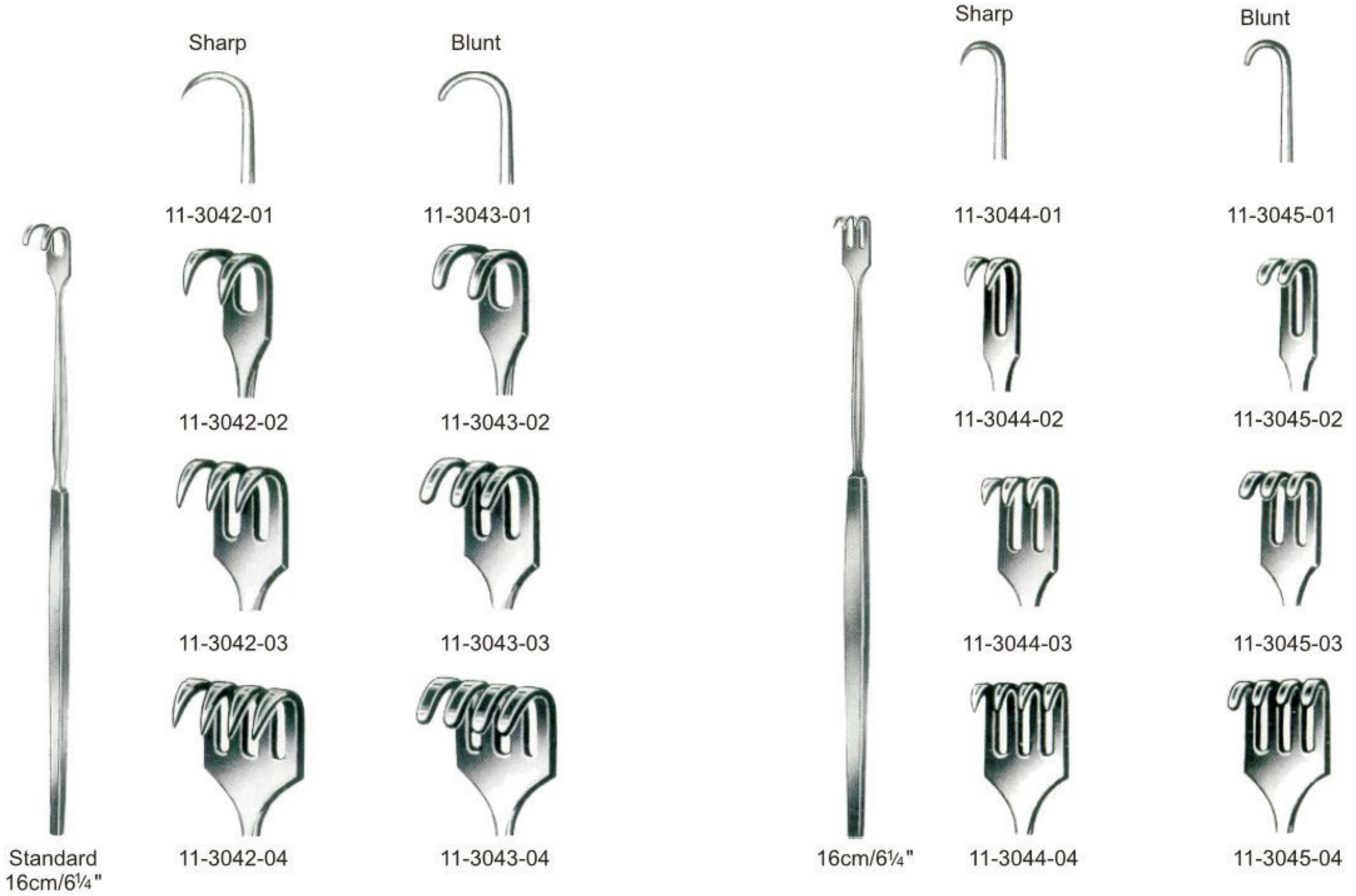



11-3050-02
 13.5cm/5¼"



Jackson
 11-3051-13
 13cm/5"



Bergmann
 11-3052-14
 14cm/5½"



Iterson
 16cm/6¼"



11-3053-16



11-3054-16



Meyerding
 18cm/7"



11-3055-18
 18x7 mm



11-3056-18
 16x5 mm



11-3055-18
 7x4 mm



11-3056-18
 10x3 mm



11-3055-18
 7x4 mm



11-3056-18



Volkmann
 11.5cm/4½"



Sharp
 11-3057-02



Blunt
 11-3058-02



11-3057-03



11-3058-03



11-3057-04



11-3058-04



11-3057-06



11-3058-06

Retractors ● EN
 Wundhaken ● DE
 Separadores ● ES

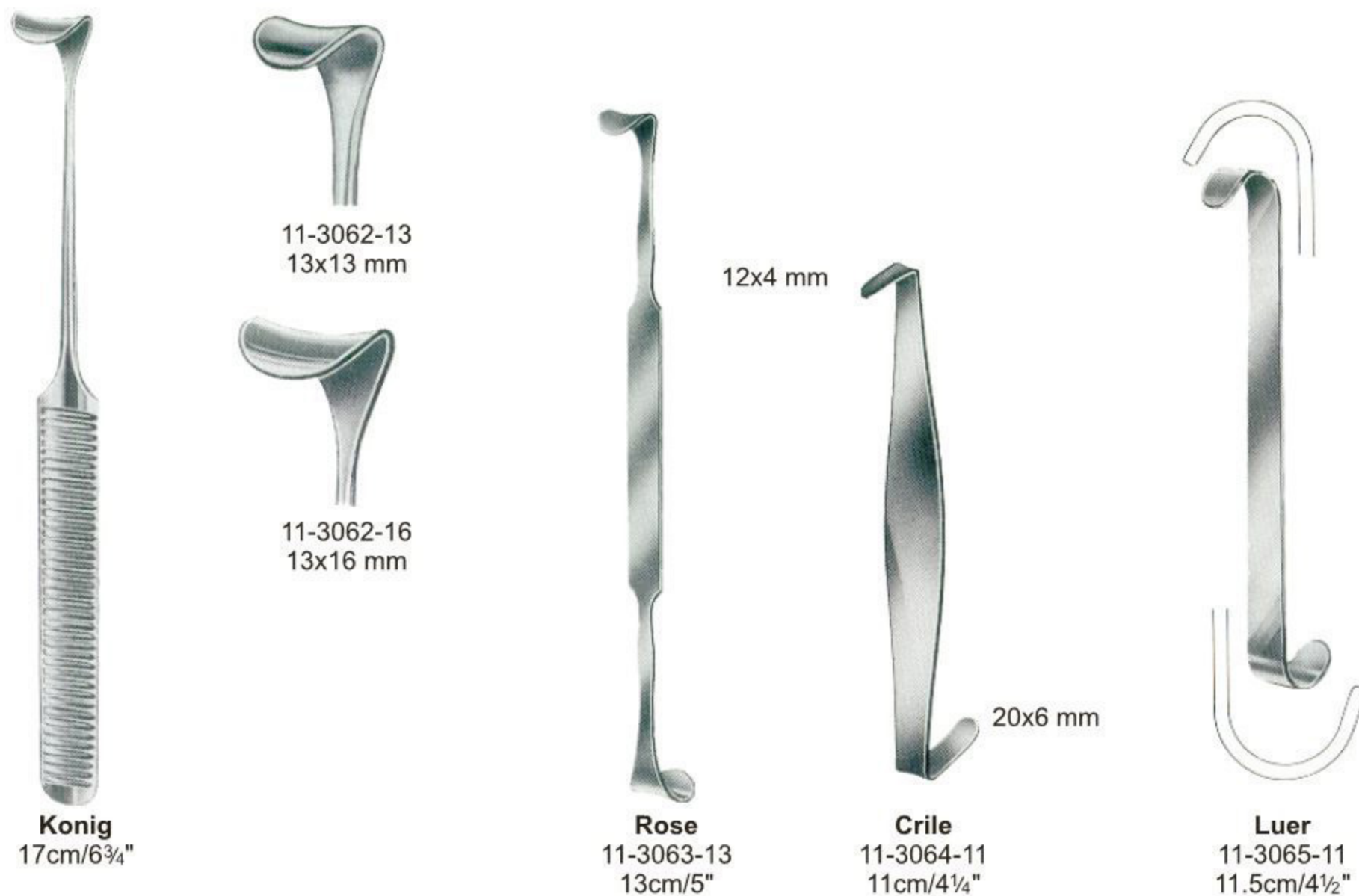
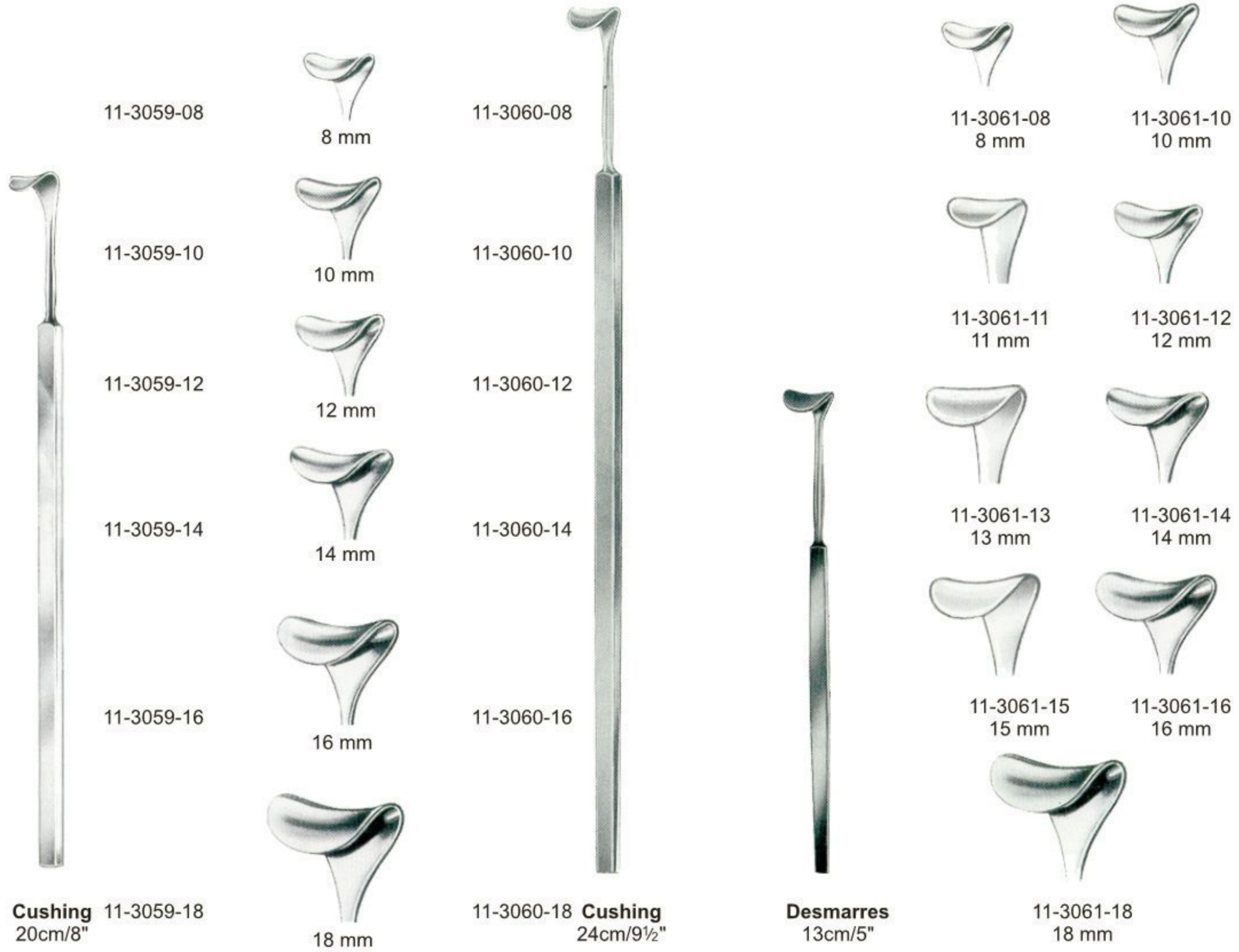

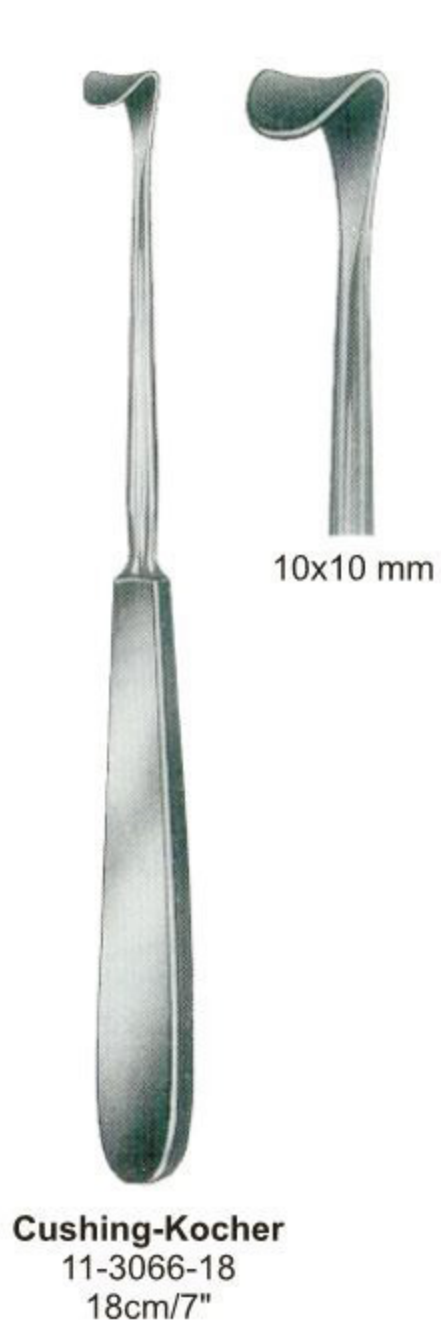



Senn-Miller
 16cm/6¼"

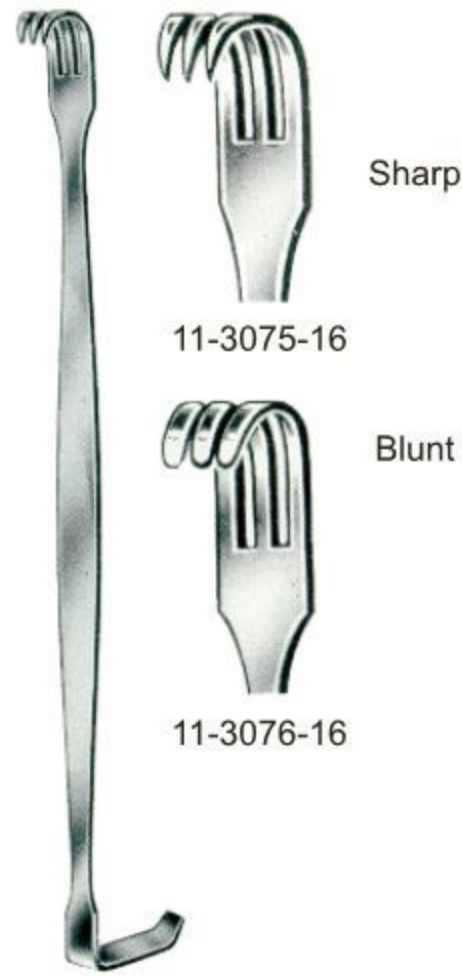

Baby-Senn-Miller
 16cm/6¼"



Rangell-Davis
 11-3077-14
 14cm/5½"



Senn-Green
 15cm/6"



Langenbeck-Green
 16cm/6¼"

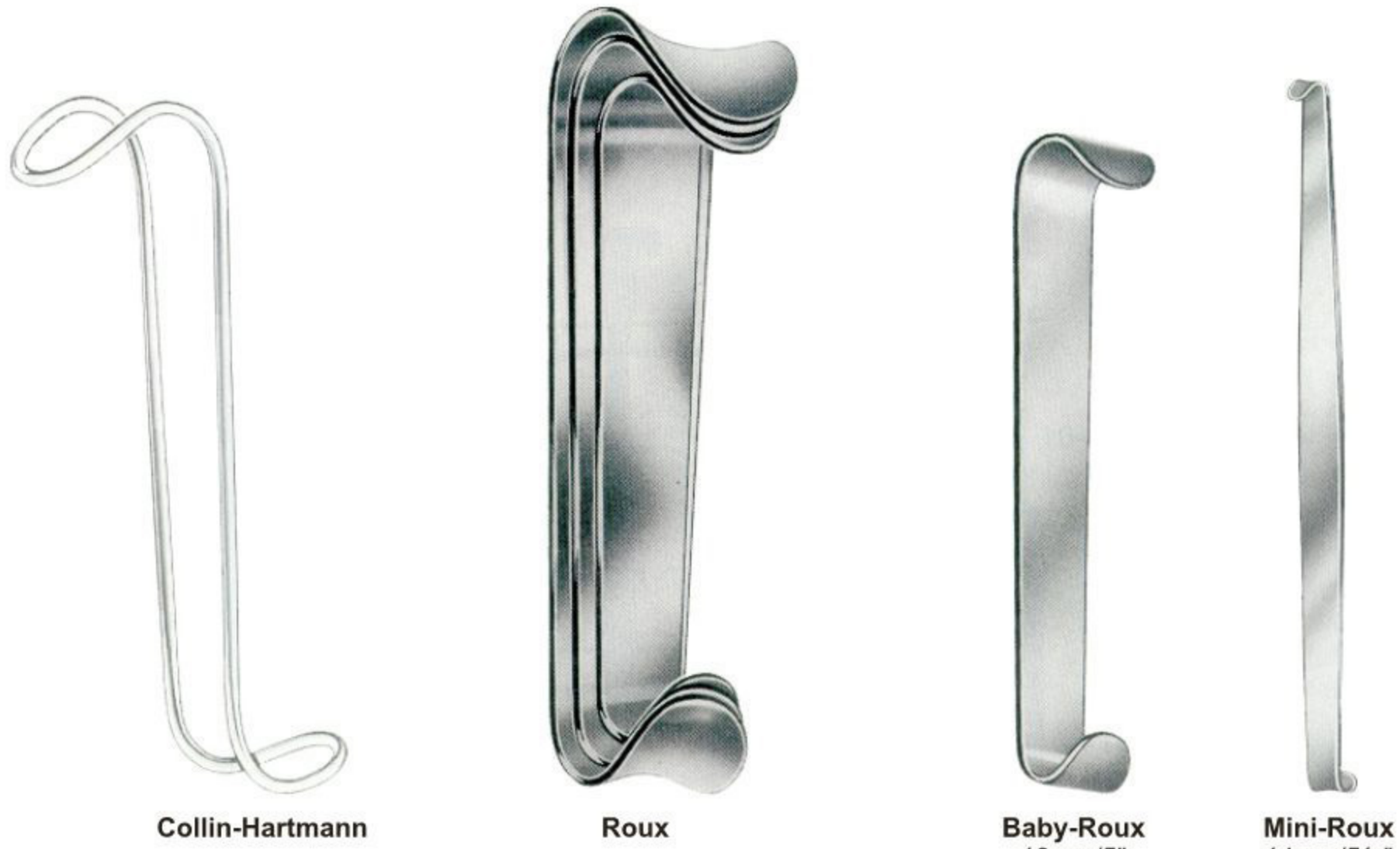

	Collin-Hartmann	Roux	Baby-Roux	Mini-Roux
			13 cm/5"	14 cm/5½"
Set	11-3084-00	Set	11-3086-13	11-3087-14
14 cm/5½"	11-3084-01	14 cm/5½" Fig. 1		
16 cm/6"	11-3084-02	15 cm/6" Fig. 2		
		17 cm/6¾" Fig. 3		

37x40 mm



37x31 mm

Goelet
 11-3088-19
 19 cm/7½"



Parker-Langenbeck (US-Army)
 11-3089-21
 21cm/8¼"

Set



Set

Parker
 11-3090-13
 13.5 cm/5¼"



Set

Parker
 11-3091-18
 18 cm/7"



Set

Parker-Mott
 11-3092-16
 16 cm/6¼"

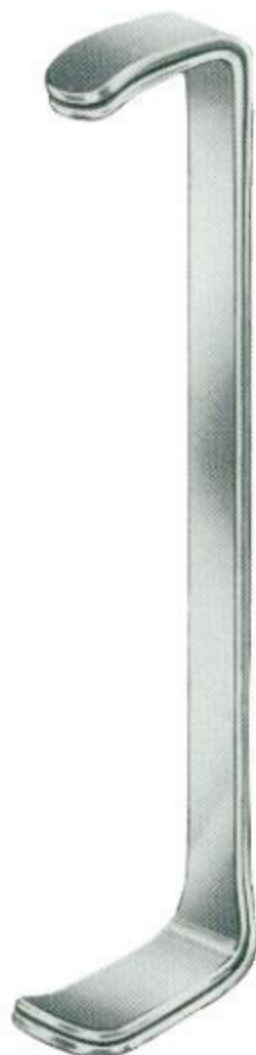

Set

Farabeuf
 11-3093-12
 12 cm/4¾"

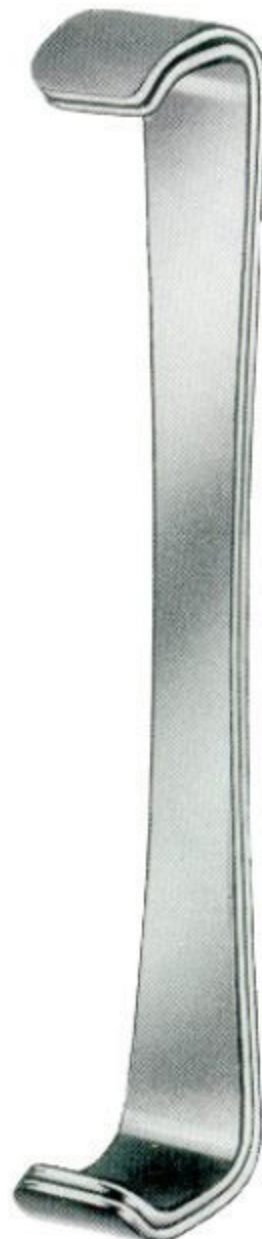

Set

Farabeuf
 11-3094-15
 15 cm/6"

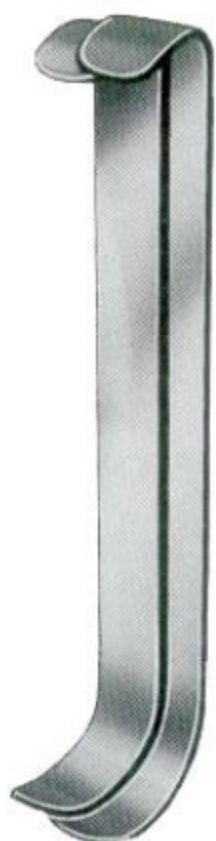
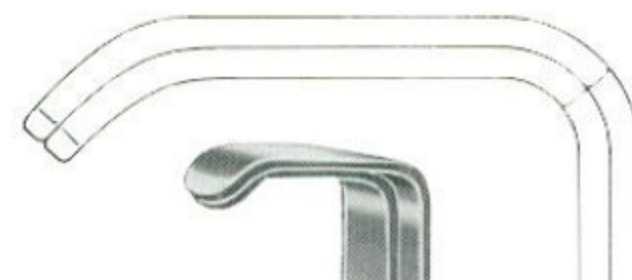

Set

Collin
 11-3095-16
 16.5 cm/6½"



Set

Mayo-Collin
 11-3096-15
 15 cm/6"



Set

Mathieu
 11-3097-19
 19 cm/7½"

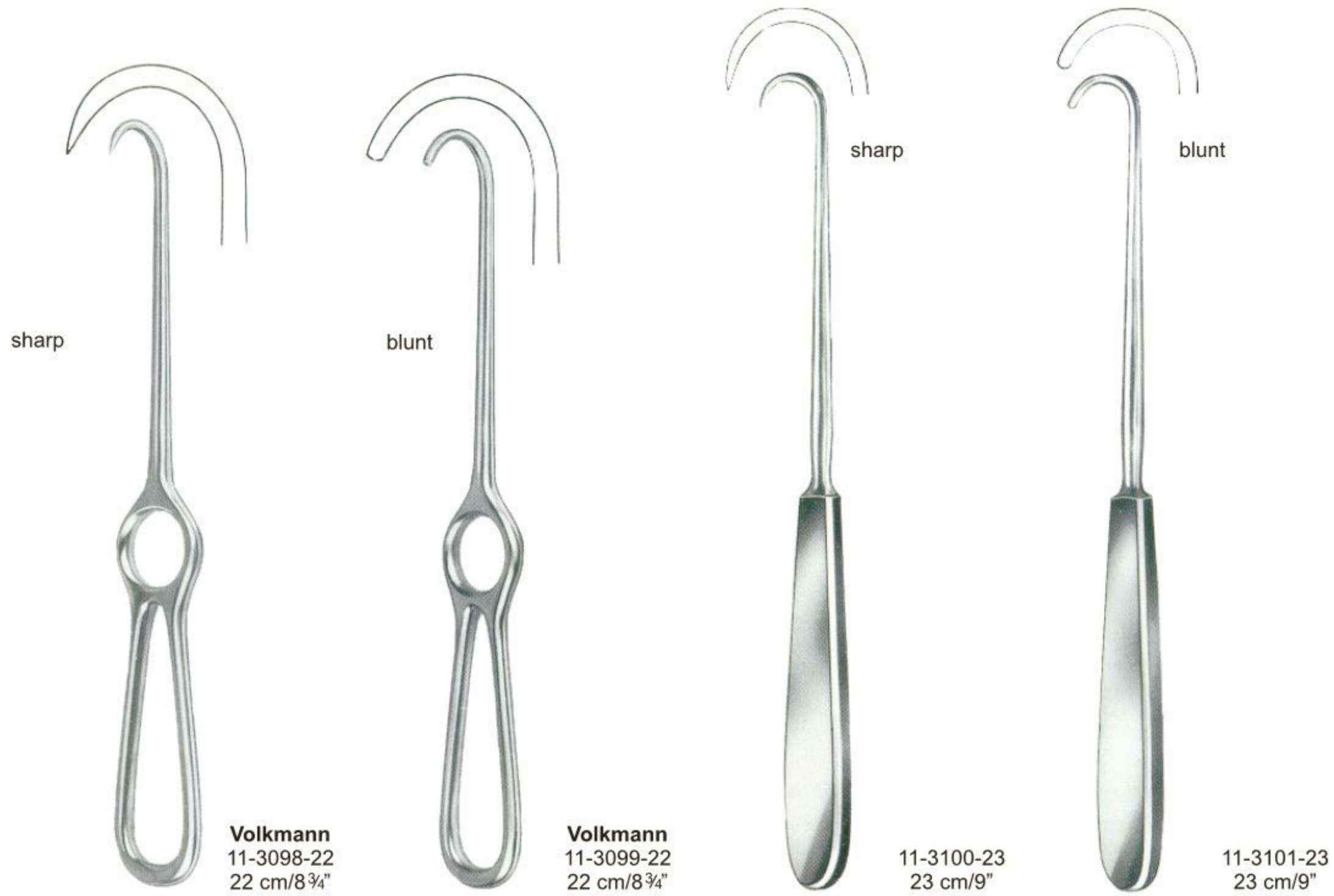

Retractors ● EN
 Wundhaken ● DE
 Separadores ● ES



Volkmann
 23 cm/9"

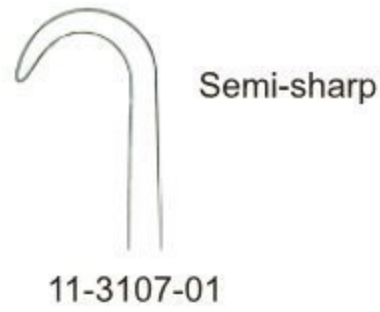



Kocher
 21.5cm/8½"



sharp

11-3116-20
 20 cm/8"



blunt

11-3117-20
 20 cm/8"

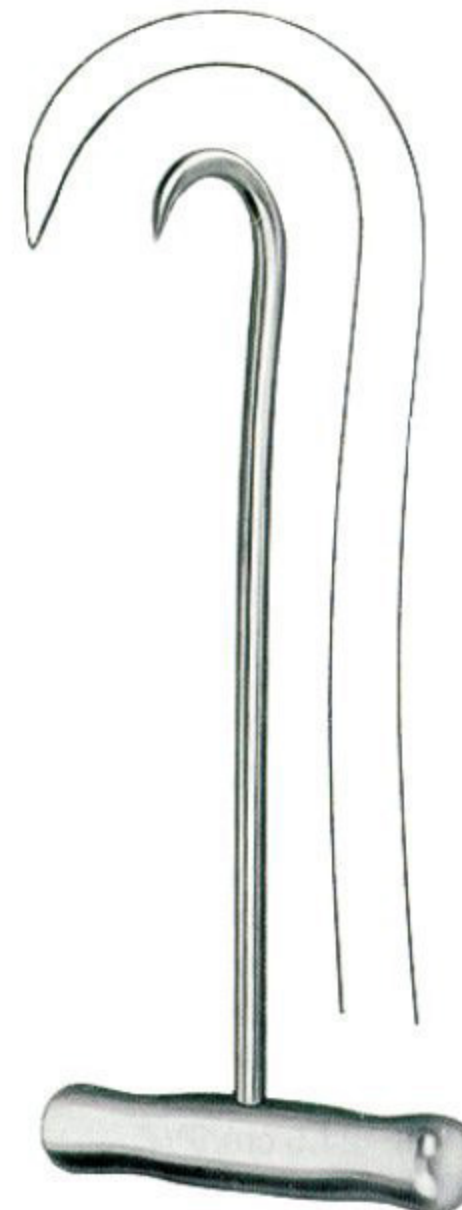

sharp

11-3118-14
 14 cm/5½"



11-3119-03
 36x30 mm



11-3120-04
 36x60 mm

Ollier
 22.5 cm/9"



Murphy
 19.5 cm/7 3/4"

Sharp



11-31121-02



11-3121-03



11-3121-04



11-3121-06

blunt



11-3122-02



11-3122-03



11-3122-04



11-3122-06



Wassmund
 11-3123-20
 20cm/8"



Israel
 25cm/10"

11-3124-02
 40x50 mm



11-3124-01
 40x40 mm



11-3124-03
 50x60 mm



11-3124-04
 70x70 mm

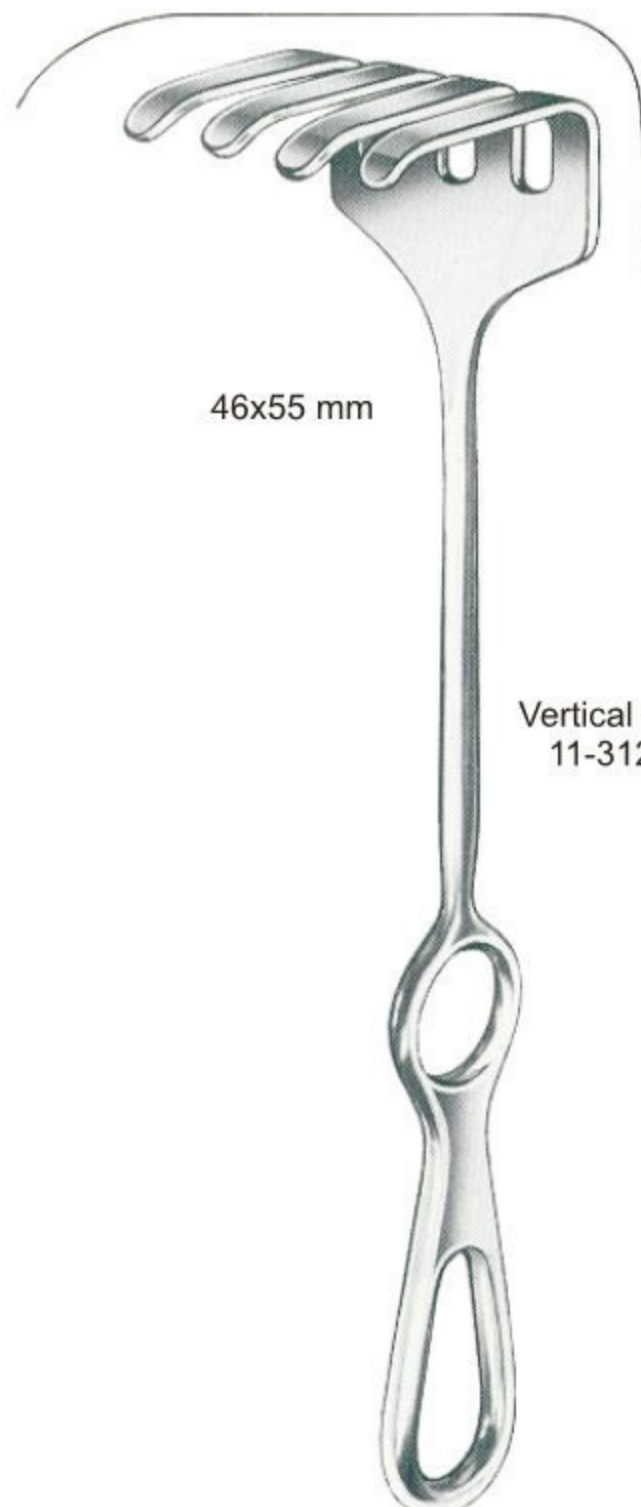

46x55 mm

Vertical Handle
 11-3125-23

Koerte
 23cm/9"



Koerte-Wagner
 11-3126-28
 28cm/11"



Koerte
 24cm/9½"

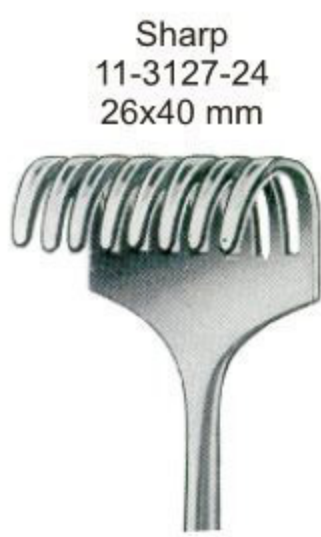

Sharp
 11-3127-24
 26x40 mm

Blunt
 11-3128-24
 26x40 mm



11-3129-24
 24cm/9½"



11-3130-25
 25cm/10"

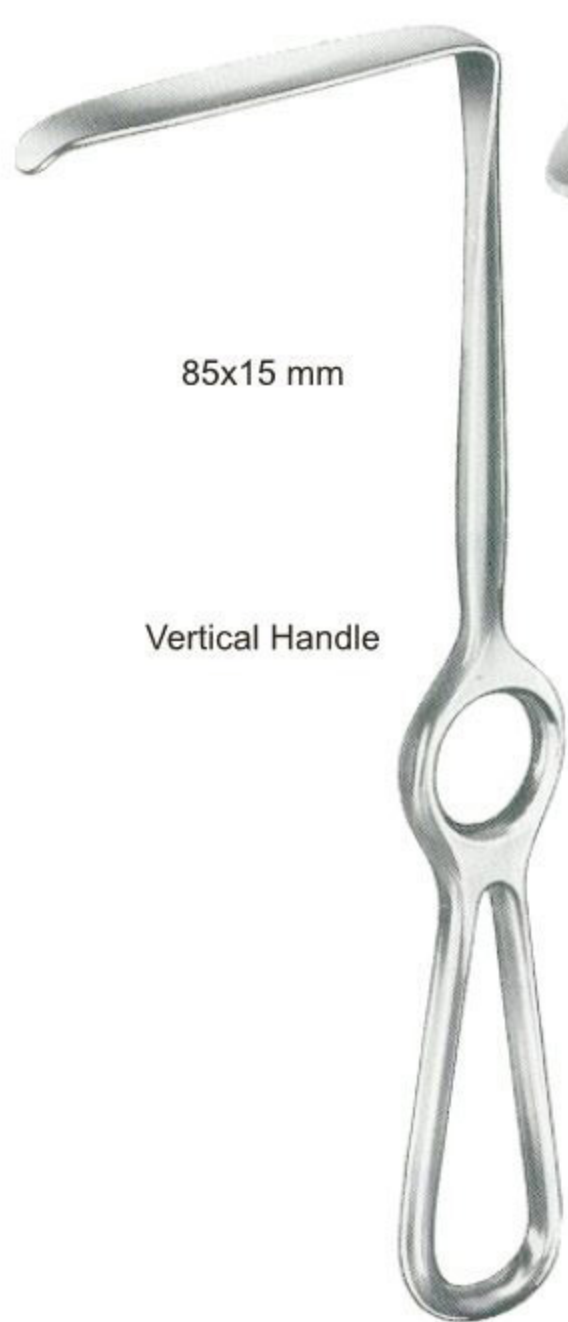

85x15 mm

Vertical Handle

Langenbeck
 11-3131-21
 21.5cm/8½"



11-3132-01
 55x20 mm
 11-3132-02
 63x20 mm
 11-3132-03
 60x20 mm

Langenbeck
 21cm/8¼"



11-3133-01
 35x7 mm
 11-3133-02
 35x10 mm
 11-3133-03
 35x15 mm
 11-3133-04
 60x20 mm

Langenbeck
 21cm/8¼"



11-3134-19
 28x6 mm

Lahey
 19cm/7½"



23cm/9"

Sauerbruch
 11-3135-01 45x15 mm
 11-3135-02 55x23 mm
 11-3135-03 72x20 mm



Langenbeck
 21cm/8¼"

11-3136-01 30x11 mm 11-3137-01
 11-3136-03 33x14 mm
 11-3136-04 30x16 mm
 11-3136-05 40x11 mm 11-3137-05
 11-3136-06 42x13 mm 11-3137-06
 11-3136-07 50x11 mm



Langenbeck
 22cm/8¾"



38x20 mm

Kocher
 11-3138-22
 22cm/8¾"

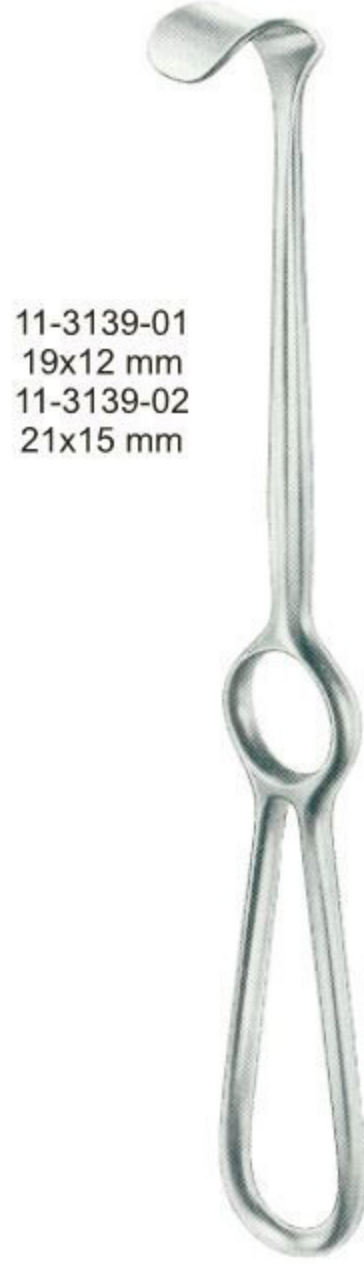

11-3139-01
 19x12 mm
 11-3139-02
 21x15 mm

Kocher
 19cm/7½"

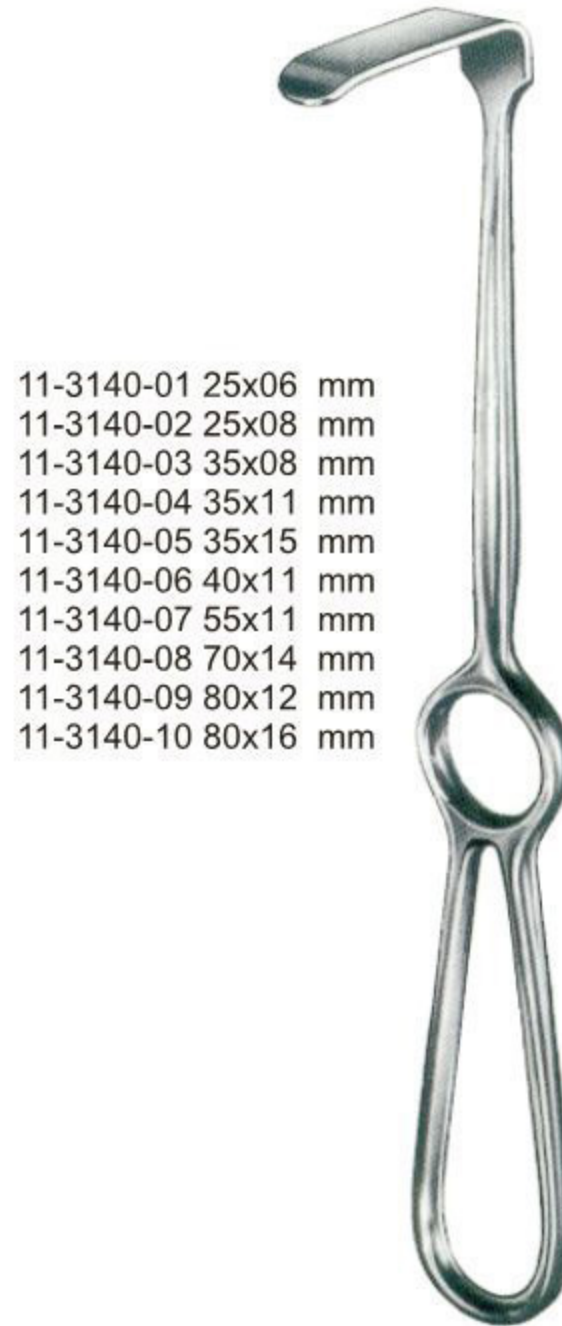

11-3140-01 25x06 mm
 11-3140-02 25x08 mm
 11-3140-03 35x08 mm
 11-3140-04 35x11 mm
 11-3140-05 35x15 mm
 11-3140-06 40x11 mm
 11-3140-07 55x11 mm
 11-3140-08 70x14 mm
 11-3140-09 80x12 mm
 11-3140-10 80x16 mm

Kocher-Langenbeck
 21.5cm/8½"



67x17cm

Casper
 11-3141-21
 21.5cm/8½"

11-3143-01
 22x15 mm



11-3143-02
 38x20 mm

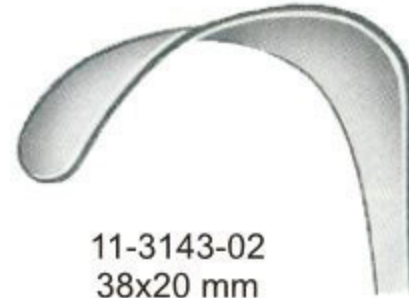

11-3143-03
 67x25 mm



11-3143-04
 100x35 mm



11-3142-01
 40x18 mm
 11-3142-02
 60x20 mm
 11-3142-03
 60x25 mm
 11-3142-04
 75x30 mm
 11-3142-05
 75x40 mm

Kocher
 23cm/9"



Kocher-Wagner
 28cm/11"



11-3144-01
 60x20 mm
 11-3144-02
 80x30 mm
 11-3144-03
 100x30 mm
 11-3144-04
 120x30 mm
 11-3144-05
 140x30 mm
 11-3144-06
 140x40 mm

Heysel
 25cm/10"





130x60 mm

St. Marks
 11-3145-29
 29cm/11½"

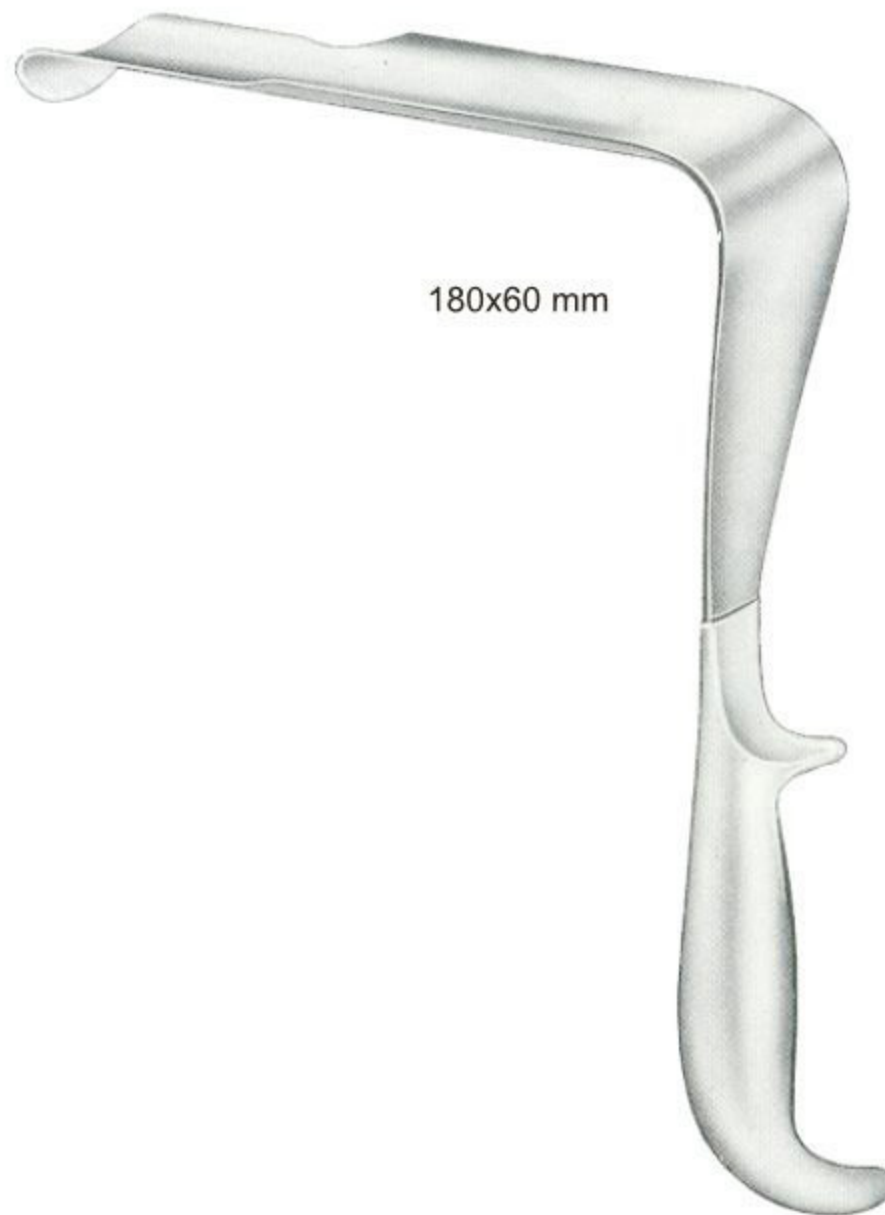

180x60 mm

St. Marks
 11-3146-32
 32.5cm/12¾"

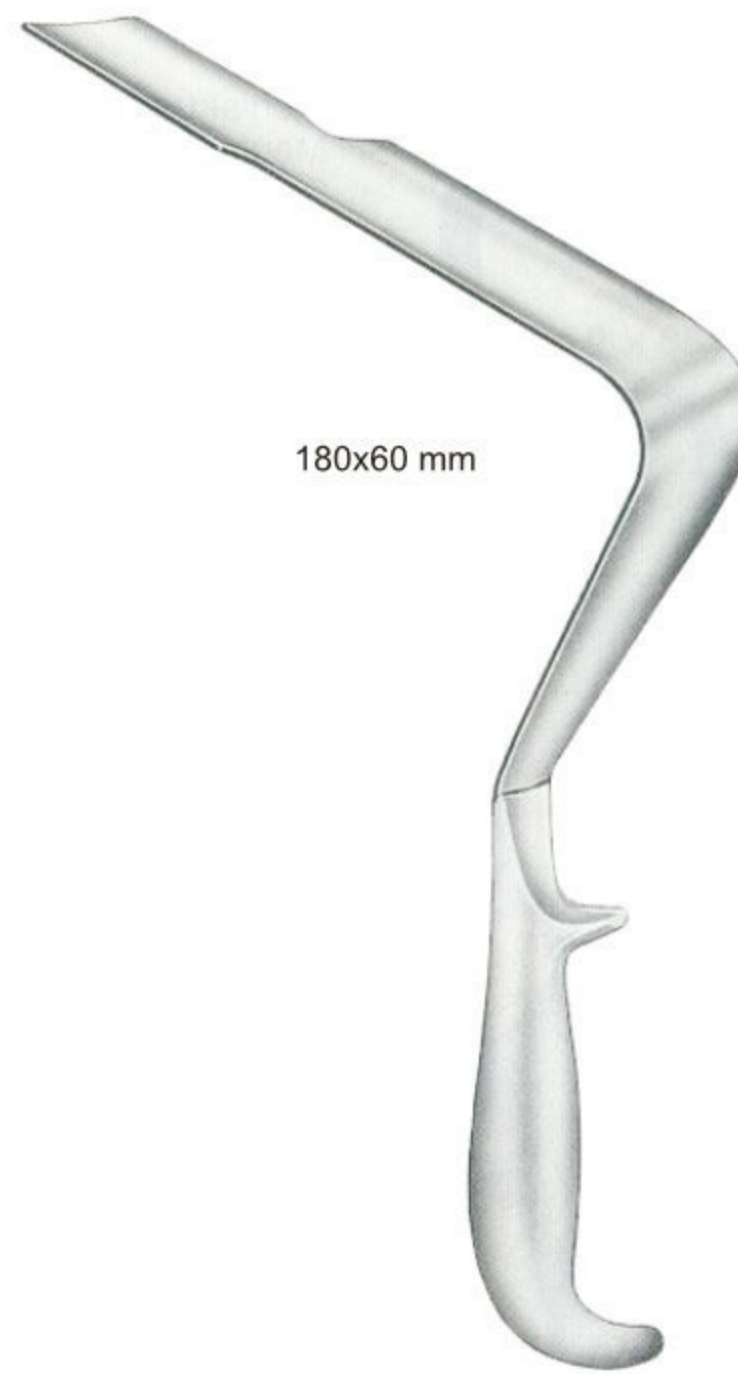

180x60 mm

St. Marks
 11-3147-33
 33cm/13"



11-3148-01
 70x40 mm
 11-3148-02
 70x50 mm
 11-3148-03
 70x65 mm

Morris
 21cm/8¼"



11-3149-01
 32x50 mm/38x50mm
 11-3149-02
 45x50 mm/50x50mm
 11-3149-03
 65x50 mm/38x50mm

Morris
 24cm/9½"



11-3150-21
 21cm/8¼"



Blount
 11-3151-18
 18cm/7"



Crawford
 19cm/7½"

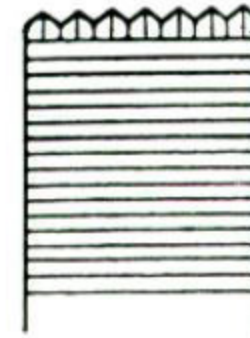

11-3152-01
 15x15 mm

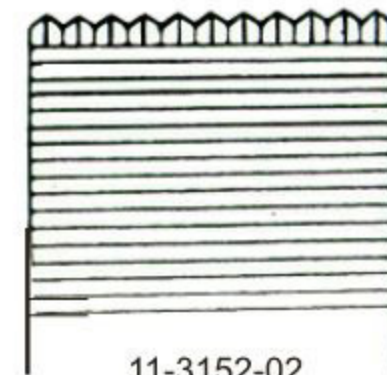

11-3152-02
 15x23 mm



Green
 11-3152-22
 22cm/8½"



Middeldorpf

11-3153-01



14x17 mm
 21.5cm/8½"

11-3153-02



22x22 mm
 22cm/8¾"

11-3153-03



26x30 mm
 23.5cm/9¼"

11-3154-01

11-3154-02

11-3154-03



Middeldorpf



11-3155-01
 45x45 mm

Middeldorpf
 25.5cm/10"

- 11-3155-01 45x45 mm
- 11-3155-02 45x50 mm
- 11-3155-03 55x70 mm



Richardson
 26cm/10¼"



11-3156-01
 28x20 mm

11-3156-02
 30x28 mm

11-3156-03
 38x37 mm

11-3156-04
 52x22 mm

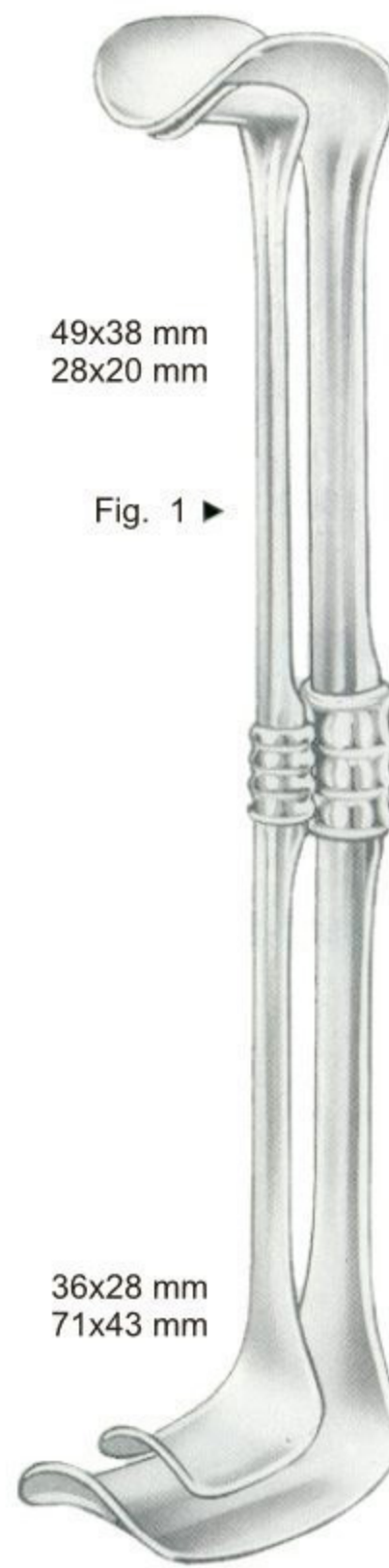

49x38 mm
 28x20 mm

Fig. 1 ▶

◀ Fig. 2

36x28 mm
 71x43 mm

Richardson-Eastman

Set 11-3157-00

Fig. 1
 26cm/10¼" 11-3157-01

Fig. 2
 28cm/11" 11-3157-02



Kelly
 26cm/10¼"

- 11-3158-01 40x50 mm
- 11-3158-02 50x65 mm
- 11-3158-03 65x75 mm
- 11-3158-04 75x90 mm

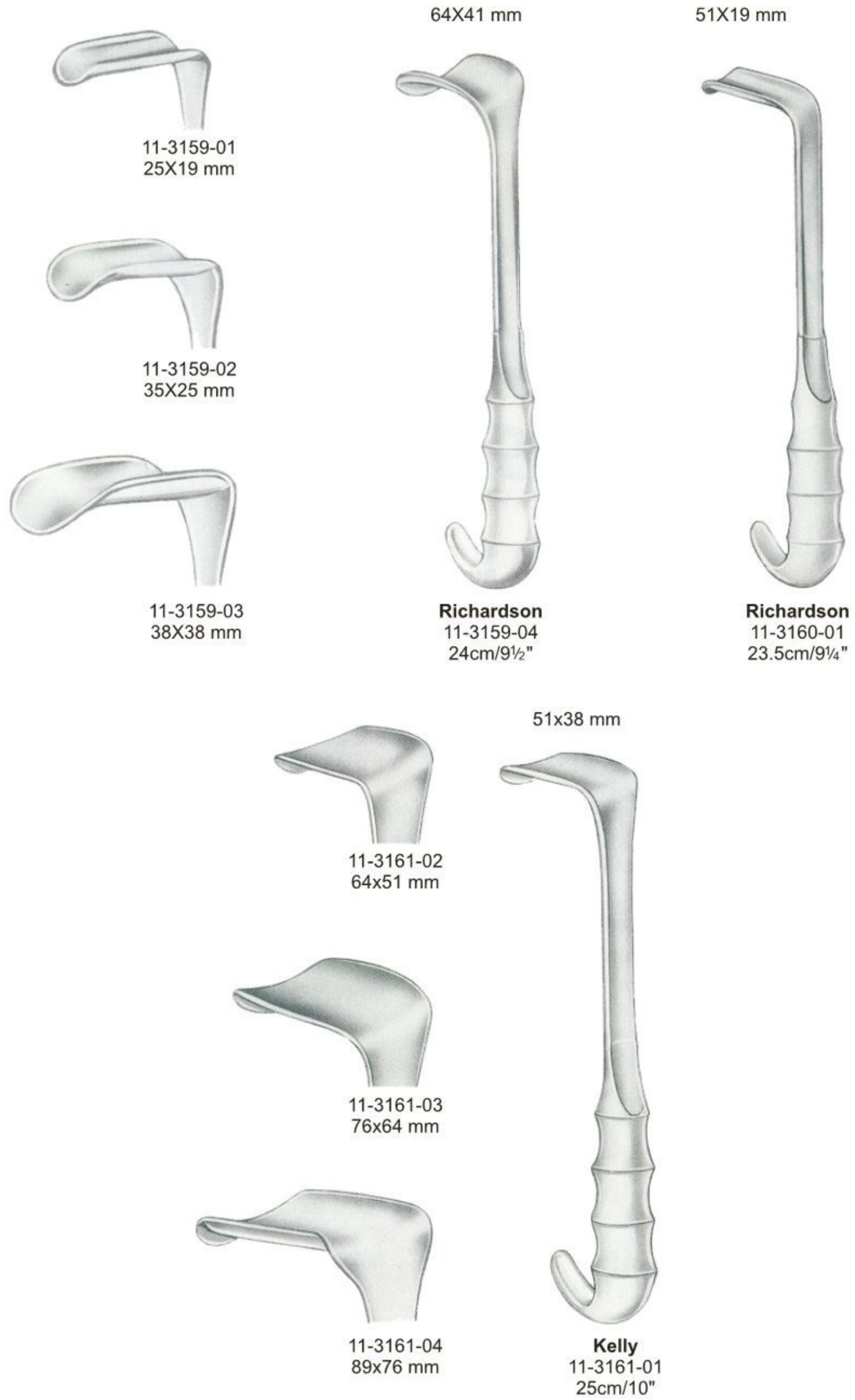

11-3162-01
 45x40 mm
 11-3162-02
 45x50 mm
 11-3162-03
 45x60 mm
 11-3162-04
 45x75 mm
 11-3162-05
 65x85 mm



Fritsch
 24cm/9½"

50x85 mm

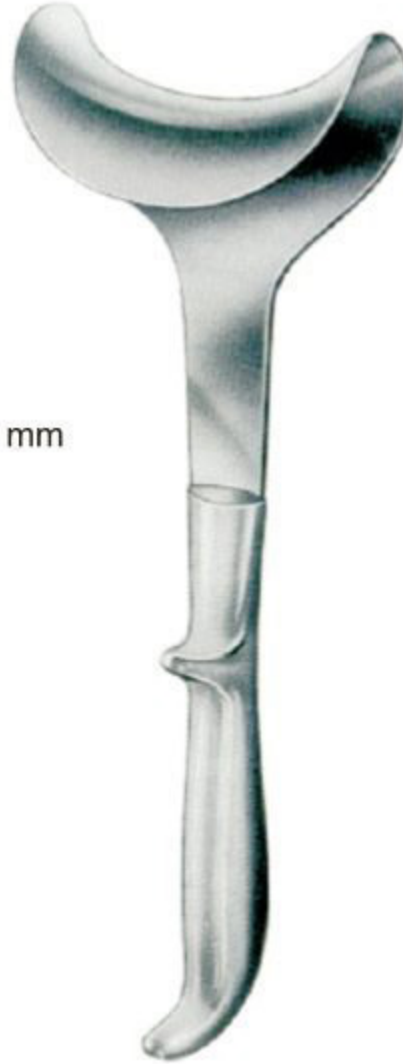

Doyen
 11-3163-25
 25cm/10"

11-3164-01
 15x90 mm
 11-3164-02
 20x90 mm
 11-3164-03
 30x90 mm
 11-3164-04
 35x110 mm
 11-3164-05
 40x110 mm
 11-3164-06
 55x120 mm

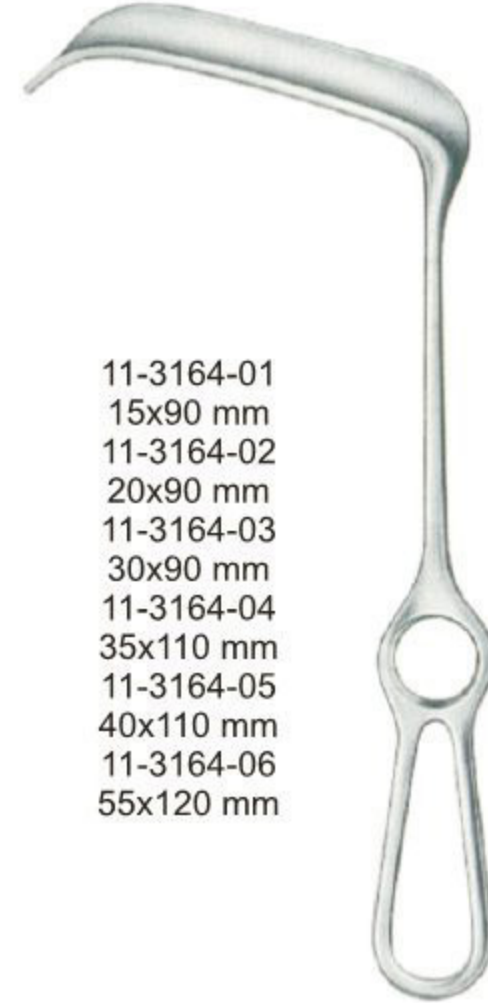

Doyen-Stille
 24cm/9½"

70x25 mm



Kocher
 11-3165-22
 22.5cm/9"

11-3166-01
 80x42 mm
 11-3166-02
 80x50 mm
 11-3166-03
 80x60 mm



Kocher
 25cm/10"

60x60 mm



Tuffier
 11-3167-23
 23cm/9"

11-3168-01
 115x22 mm



Simon
 28cm/11"

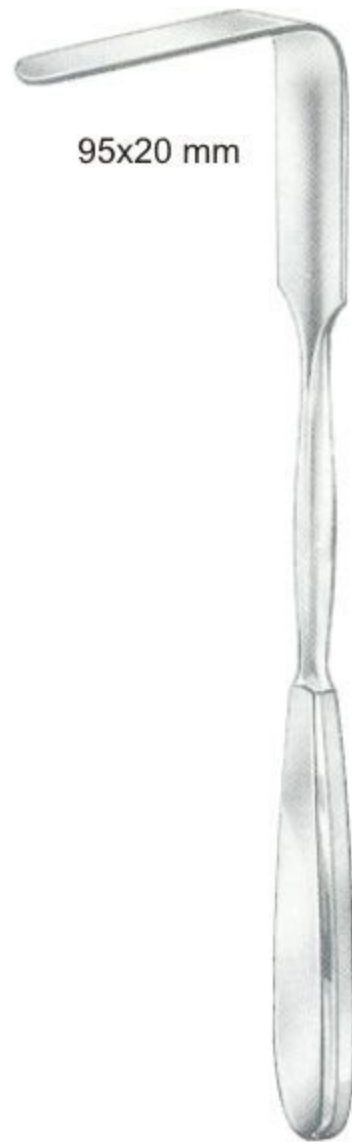

95x20 mm

Tuebingen
 11-3169-28
 28cm/11"

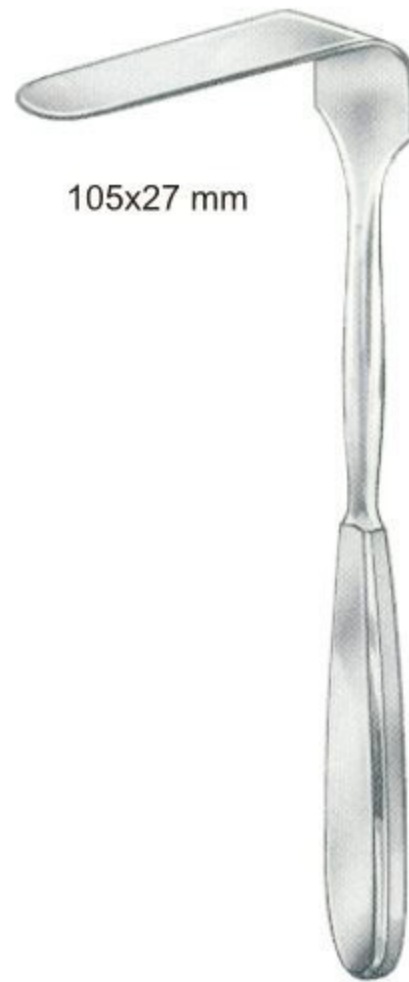

105x27 mm

Martin
 11-3170-26
 26cm/10¼"

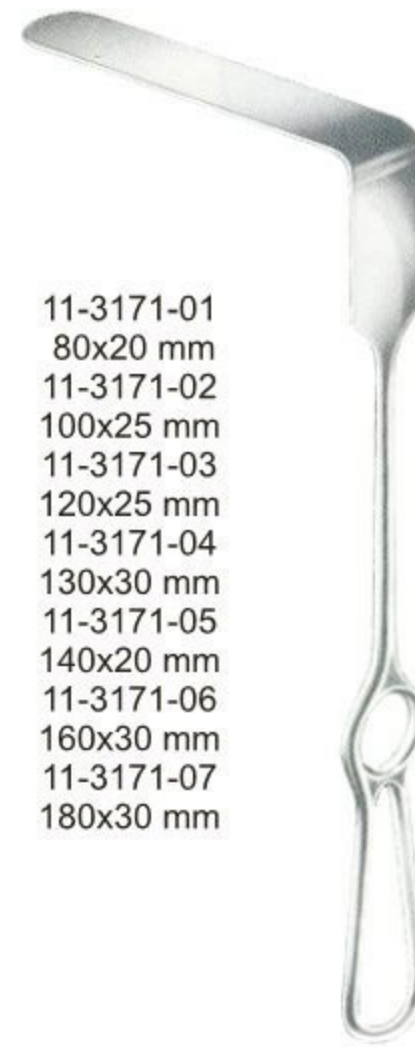

- 11-3171-01
80x20 mm
- 11-3171-02
100x25 mm
- 11-3171-03
120x25 mm
- 11-3171-04
130x30 mm
- 11-3171-05
140x20 mm
- 11-3171-06
160x30 mm
- 11-3171-07
180x30 mm

Brunner
 25cm/10"

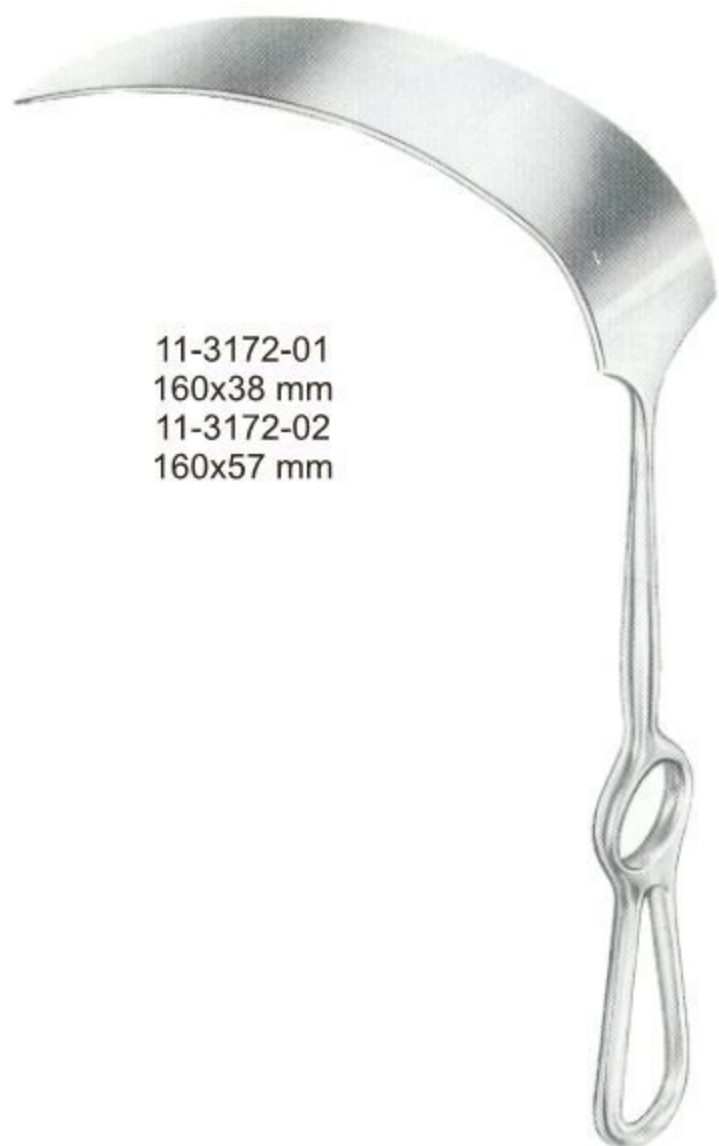

11-3172-01
 160x38 mm
 11-3172-02
 160x57 mm

Kelly
 27cm/10½"



Polloson
 11-3173-27
 27cm/10½"



Polloson
 11-3174-27
 27cm/10½"



11-3175-03
 115x65 mm

11-3175-02
 115x38 mm

11-3175-01
 82x20 mm

Coryllos
 23.0cm/9"



11-3175-25
 130x38 mm

Sauerbruch
 25cm/10"





11-3185-01
 50x16 mm
 11-3185-02
 75x25 mm
 11-3185-03
 90x50 mm

Meyerding
 22.5cm/9"



Zenker

11-3186-01 25cm/10" 35x08 mm
 11-3186-02 26cm10¼" 60x12 mm
 11-3186-03 27.5cm/10¾" 75x12 mm

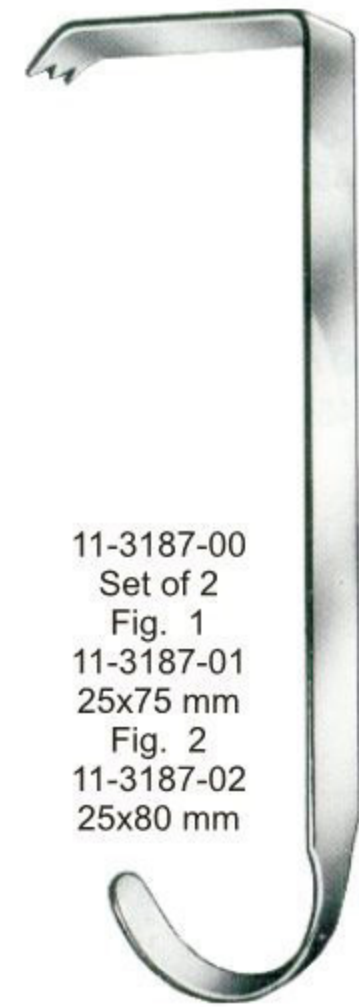

11-3187-00
 Set of 2
 Fig. 1
 11-3187-01
 25x75 mm
 Fig. 2
 11-3187-02
 25x80 mm

Hibbs
 24cm/9½"

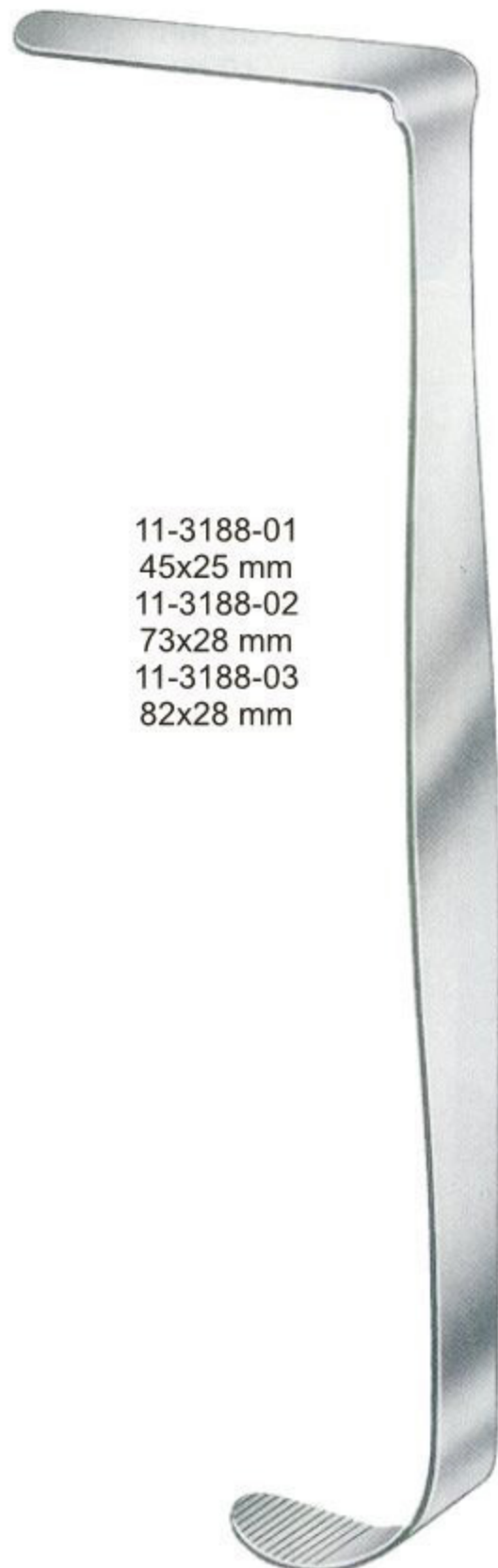

11-3188-01
 45x25 mm
 11-3188-02
 73x28 mm
 11-3188-03
 82x28 mm

Heaney
 27cm/10½"

46 mm



Kuemmel
 11-3189-33
 33cm/13"

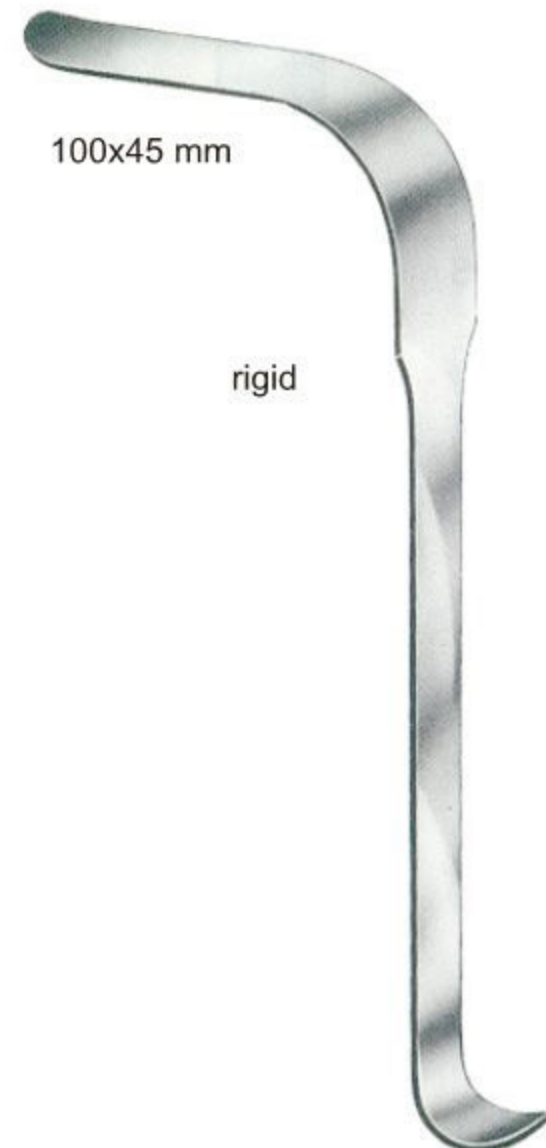

100x45 mm

rigid

Koerte
 11-3190-28
 28cm/11"

11-3191-20
 20 mm
 11-3191-30
 30mm
 11-3191-40
 40 mm



Kader
 27cm/10½"



11-3192-01
 25.5cm/10"
 45 mm
 11-3192-02
 27.5cm/10¾"
 60 mm

Leriche



Malleable
 11-3193-01 20 mm
 11-3193-02 25 mm
 11-3193-03 30 mm
 11-3193-04 35 mm
 11-3193-05 40 mm
 11-3193-06 45 mm
 11-3193-07 50 mm
 11-3193-08 64 mm
 11-3193-09 76 mm
 11-3193-10 102 mm
 33cm/13"

Malleable



Tuffier
 11-3194-20
 20 cm/8"
 17x25 mm

Malleable

11-3195-01
 200x6 mm
 11-3195-02
 200x8 mm
 11-3195-03
 200x10 mm
 11-3195-04
 200x12 mm
 11-3195-05
 200x17 mm
 11-3195-06
 200x20 mm
 11-3195-07
 200x25 mm
 11-3195-08
 250x25 mm



20cm/8"

Malleable

11-3196-01
 280x25/30 mm
 11-3196-02
 300x37/45 mm
 11-3196-03
 300x40/50 mm



Haberer
 21cm/8¼"



Reverdin
 11-3197-28
 28 cm/11"



Davidson
 16cm/6¼"

75x50 mm
 75x90 mm

11-3198-01
 11-3198-02



Cooley
 11-3199-01
 21.5cm/8½"



Cooley
 11-3199-02
 21.5cm/8½"



Cooley
 11-3199-03
 23cm/9"



Ross
 27cm/10½"

- Fig. 1 11-3200-01 13x13 mm
- Fig. 2 11-3200-02 14x12 mm
- Fig. 3 11-3200-03 18x18 mm
- Fig. 4 11-3200-04 20x20 mm
- Fig. 5 11-3200-05 22x18 mm
- Fig. 6 11-3200-06 26x24 mm



Retractors ● EN
 Wundhaken ● DE
 Separadores ● ES



22cm/8¾"

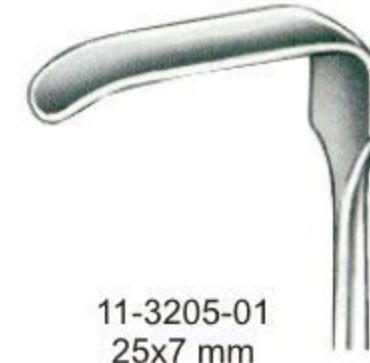

11-3205-01
 25x7 mm



11-3205-02
 31x10 mm



11-3205-03
 42x11 mm



11-3205-04
 55x12 mm



11-3205-05
 70x14 mm



11-3205-06
 80x18 mm



22cm/8¾"



11-3206-01
42x13 mm



11-3206-02
60x12 mm



11-3206-03
80x16 mm

Retractors ● EN
 Wundhaken ● DE
 Separadores ● ES



Spina-Nasalis
 11-3207-01
 22 cm/8¾"

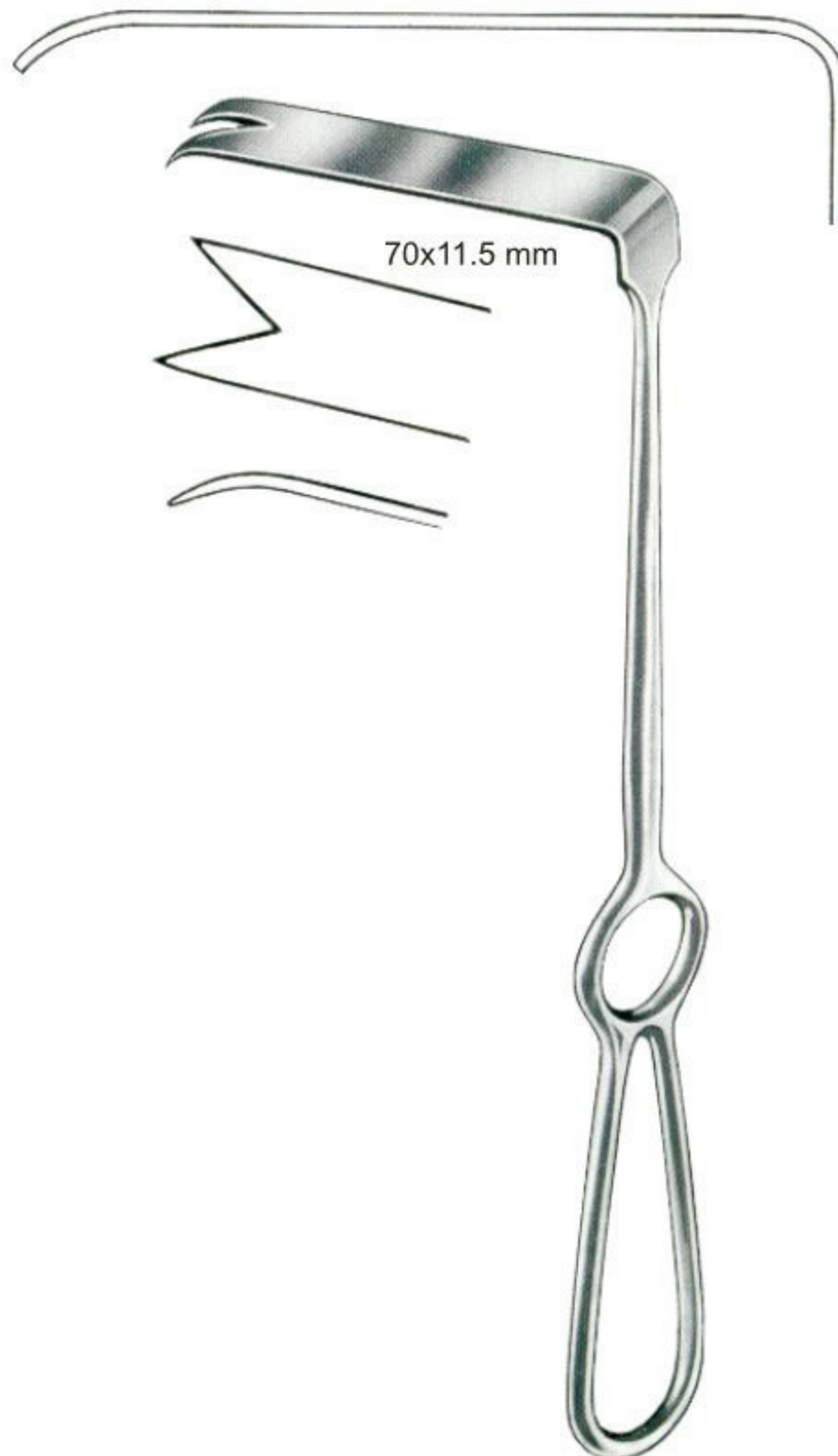

Ramus
 11-3208-02
 22 cm/8¾"



11-3209-15
 15.5 cm/6"



11-3210-16
 16 cm/6¼"

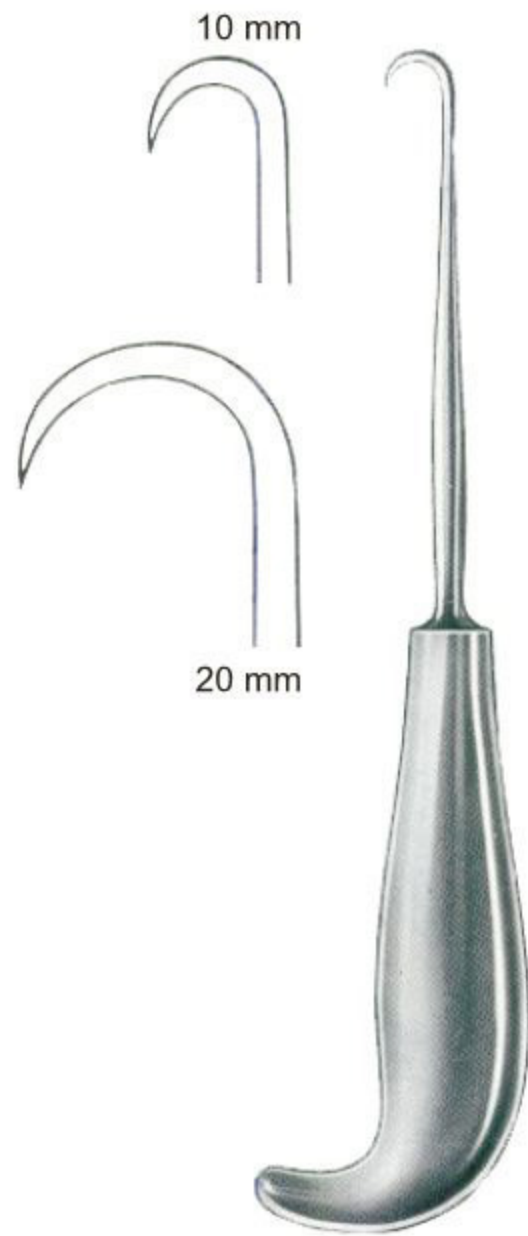

11-3211-10 10 mm
 11-3211-20 20 mm
 19cm/7½"



Dingman
 11-3212-17
 17.5cm/7"



Soeresen-Hein
 11-3213-17
 17.5cm/7"



Dingman
 11-3214-21
 21cm/8¼"



11-3215-18
 18.5cm/7¼"

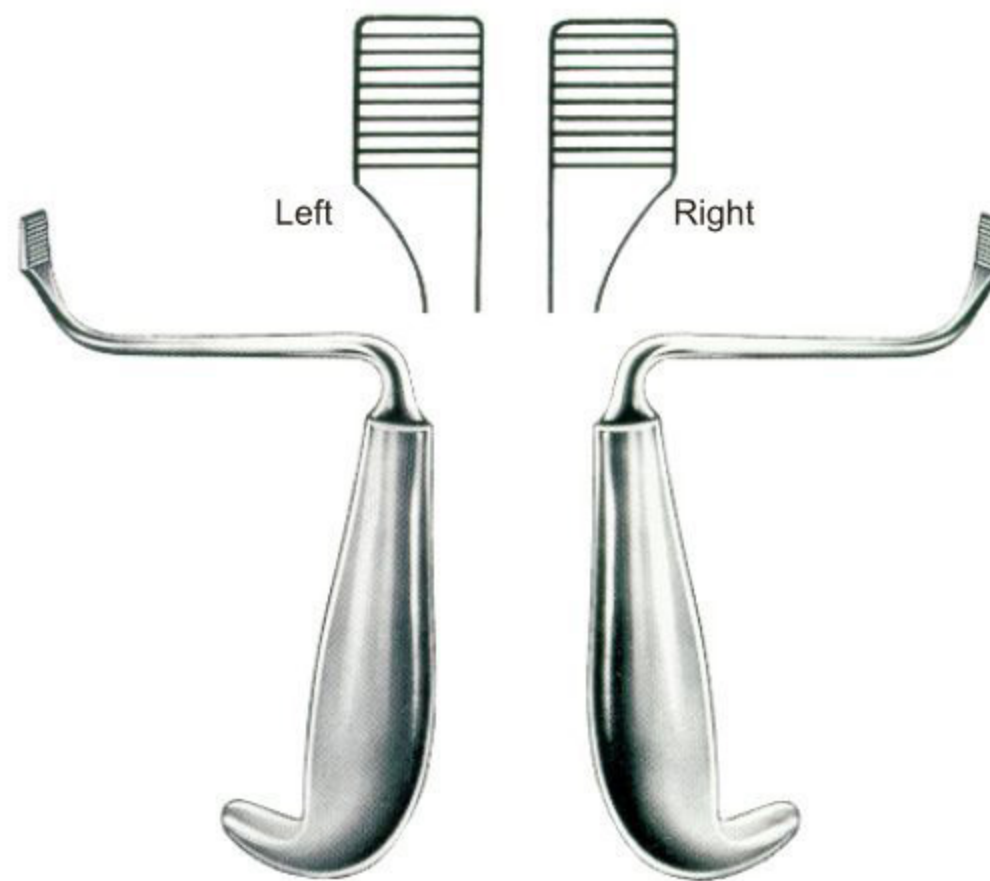

Tessier
 11-3216-01
 15cm/6"

Tessier
 11-3217-02
 15cm/6"



Dingman
 11-3218-00

Retractors ● EN
 Wundhaken ● DE
 Separadores ● ES



11-3219-21
 21cm/8¼"



11-3220-20
 20.5cm/8"



11-3221-17
 17.5cm/7"

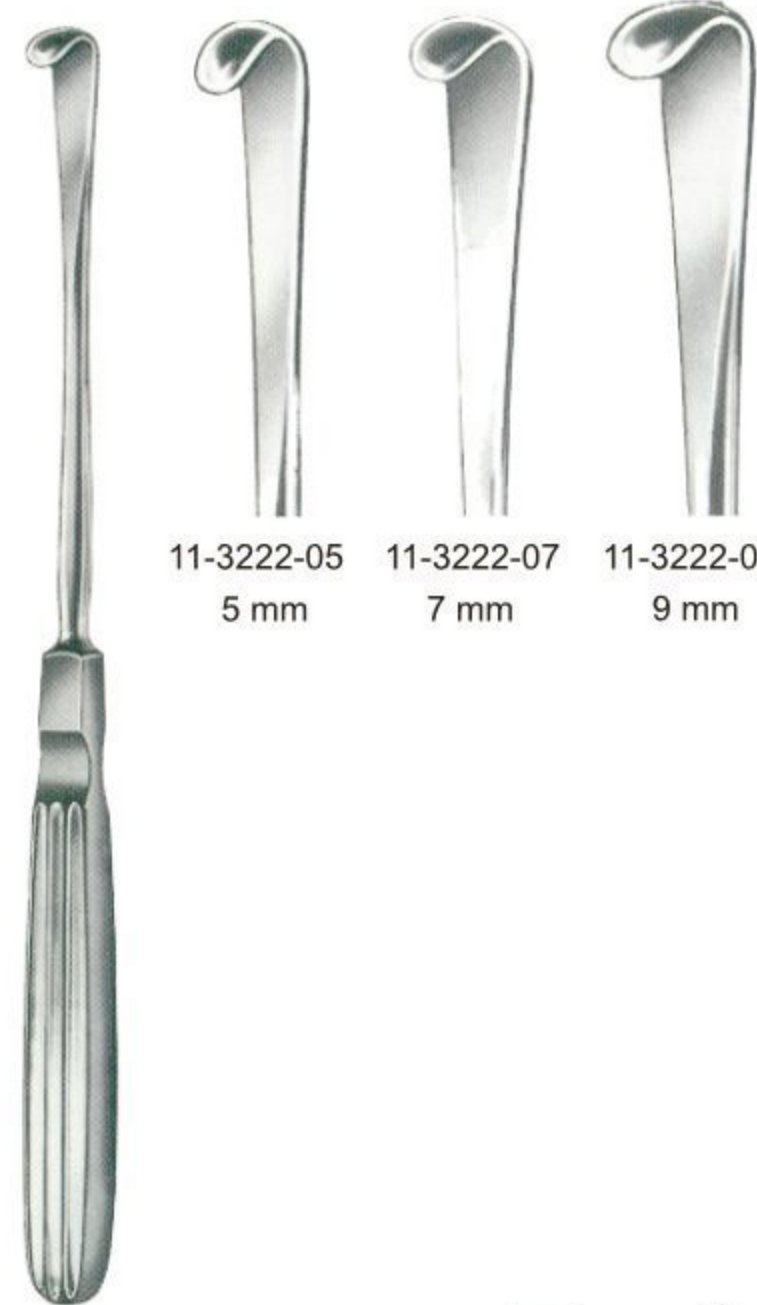

11-3222-05
 5 mm

11-3222-07
 7 mm

11-3222-09
 9 mm

20cm/8"



17.5cm/7"



11-3223-06
 6 mm



11-3223-07
 7 mm



11-3223-09
 9 mm



11-3223-11
 11 mm

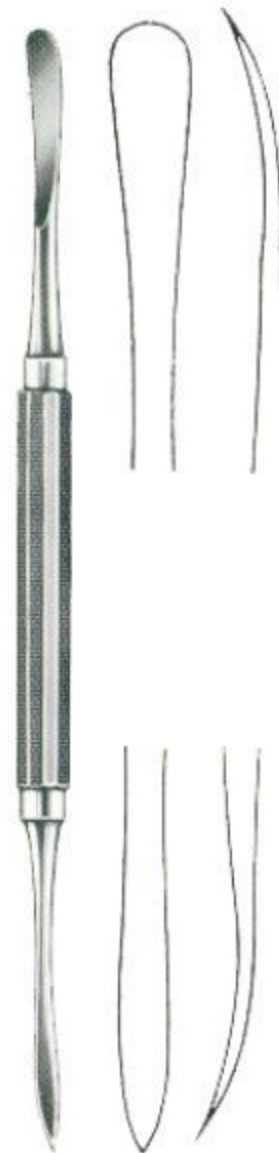

Dingman
 11-3224-18
 18cm/7"



11-3225-23
 23.5cm/9¼"
 10 mm



Tessier
 20.5cm/8"



11-3226-10
 10 mm



11-3227-10
 10 mm



11-3228-01
 18.5cm/7¼"

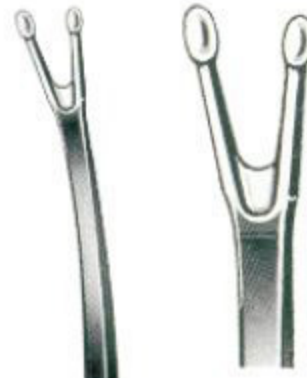

11-3229-02
 18.5cm/7¼"



11-3230-07
 7 mm
 21.5cm/8½"



11-3231-10
 10 mm
 21.5cm/8½"



15cm/6"



11-3232-02
 2.5 mm



11-3232-04
 4 mm



Bowdler-Henry's
 11-3233-16
 16.5cm/6½"



Gillies
 11-3234-21
 21cm/8¼"



Gillies
 11-3235-21
 21cm/8¼"

Retractors ● EN
 Wundhaken ● DE
 Separadores ● ES



Sanders-Brown
 11-3236-30
 30cm/12"



Sanders-Brown
 11-3237-29
 29cm/11½"



11-3238-14
 14cm/5½"



11-3239-23
 23cm/9"



11-3240-18
 18cm/7"



Kelsey-Fry
 11-3241-15
 15cm/6"



Kelsey-Fry
 11-3242-18
 18cm/7"



Mershon
 11-3243-14
 14.5cm/5½"



Bose



Finsen



Finsen

Sharp

Blunt

Sharp

cm	in				
5	2		11-3245-05	11-3246-05	
7	2¾"	11-3244-07	11-3245-07	11-3246-07	11-3247-07



Allport
 11-3248-09
 9.5cm/3¾"



Alm

Sharp

Blunt

cm	in		cm	in		
8.5	3½"	11-3248-08	7	2¾"	11-3249-07	11-3250-07
11.5	4½"	11-3248-11	10	4	11-3249-10	11-3250-10



Holzheimer
 Sharp 11-3251-10 10 cm/4"
 blunt 11-3252-10



Jansen
 Sharp 11-3253-10 10.5 cm/4¼"
 blunt 11-3254-10



Jansen-Deep
 Sharp 11-3255-10 10.5 cm/4¼"
 blunt 11-3256-10



Plester
 11-3257-11
 11.5 cm/4½"



Plester
 11-3258-11
 11.5 cm/4½"

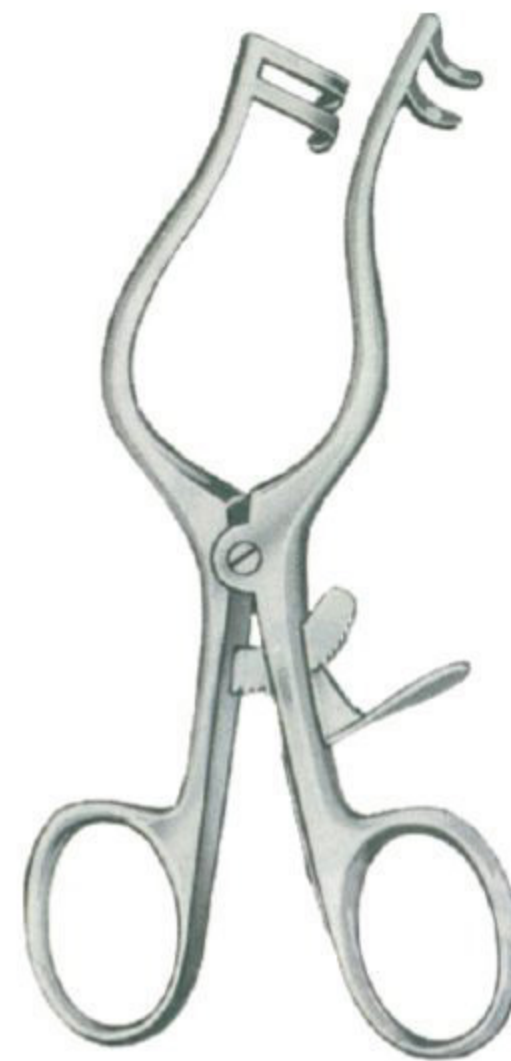

Plester
 Sharp 11-3259-13 13 cm/5"
 blunt 11-3260-13

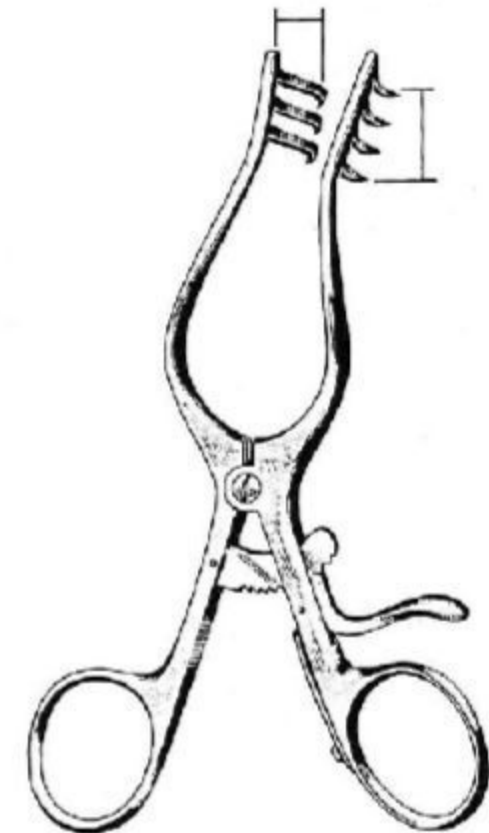

	Weitlaner		Weitlaner		Weitlaner-Wullstein	
	Sharp	Blunt	Sharp	Blunt	Sharp	Blunt
10.5 cm/4¼"	11-3261-10	11-3262-10				
13.0 cm/5"	11-3261-13	11-3262-13	11-3263-13	11-3264-13	11-3265-13	11-3266-13
14.0 cm/5½"	11-3261-14	11-3262-14	11-3263-14	11-3264-14	11-3265-14	11-3266-14
16.5 cm/6½"	11-3261-16	11-3262-16	11-3263-16	11-3264-16	11-3265-16	11-3266-16



Mollison
 11-3267-15
 15 cm/6"



Tuebinger-Modell
 11-3268-16
 16 cm/6¼"



Henner(Lempert)
 11-3269-12
 12 cm/4½"

Complete with 2 pairs of blades and centre blade

Complete with 3 Central blades

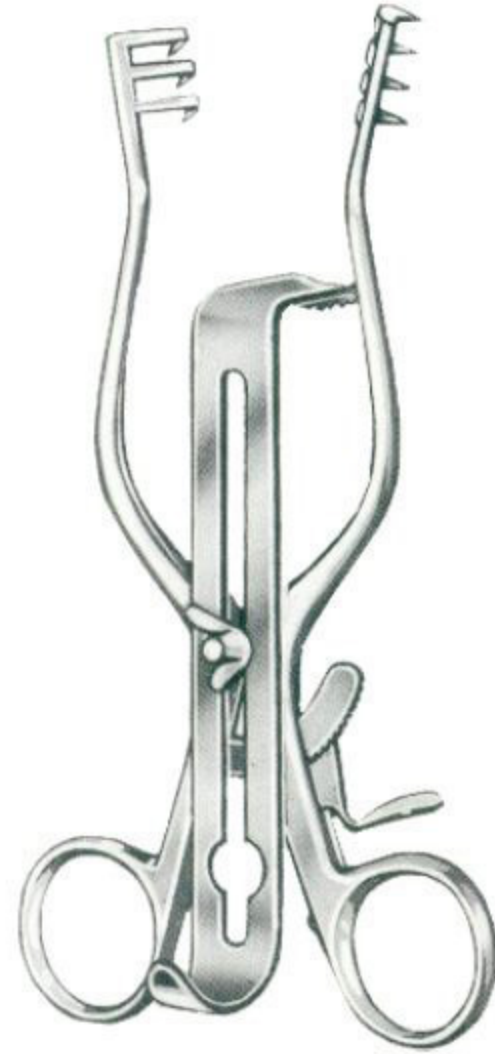

Central blades, only



Henley
 Sharp 11-3270-16
 16.5 cm/6½"
 Blunt 11-3271-16

11-3272-19 16x19 mm
 11-3272-25 16x25 mm
 11-3272-32 16x32 mm



Weitlaner-Baby

13 cm/5"
 16 cm/6¼"
 11-3273-13



Milligan

Sharp 11-3274-13
 Blunt 11-3275-13



Cone (Adson-Baby)

Sharp 11-3276-13
 11-3276-16
 Blunt 11-3277-13
 11-3277-16



Weitlaner

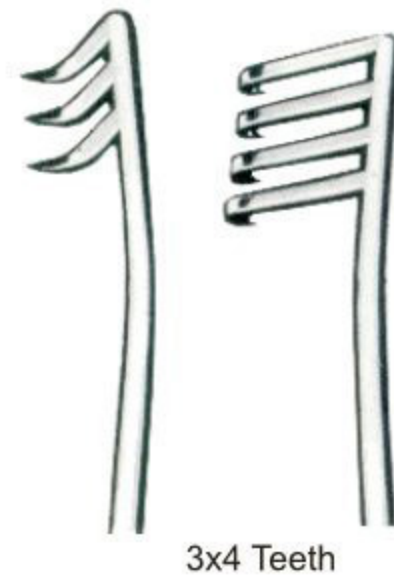

3x4 Teeth

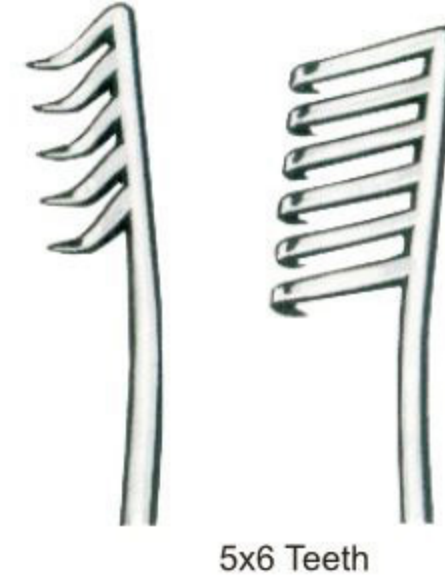

5x6 Teeth

	Sharp	Blunt	Sharp	Blunt
20 cm/8"	11-3278-20	11-3279-20		
25 cm/10"	11-3278-25	11-3279-25	11-3280-25	11-3281-25



Adson

	Sharp	Blunt
20 cm/8"	11-3282-20	11-3283-20
26 cm/10¼"	11-3282-26	11-3283-26



Anderson-Adson

	Sharp	Blunt
	11-3284-20	11-3285-20



Cone

	Sharp	Blunt
	11-3286-20	11-3287-20
	11-3286-26	11-3287-26

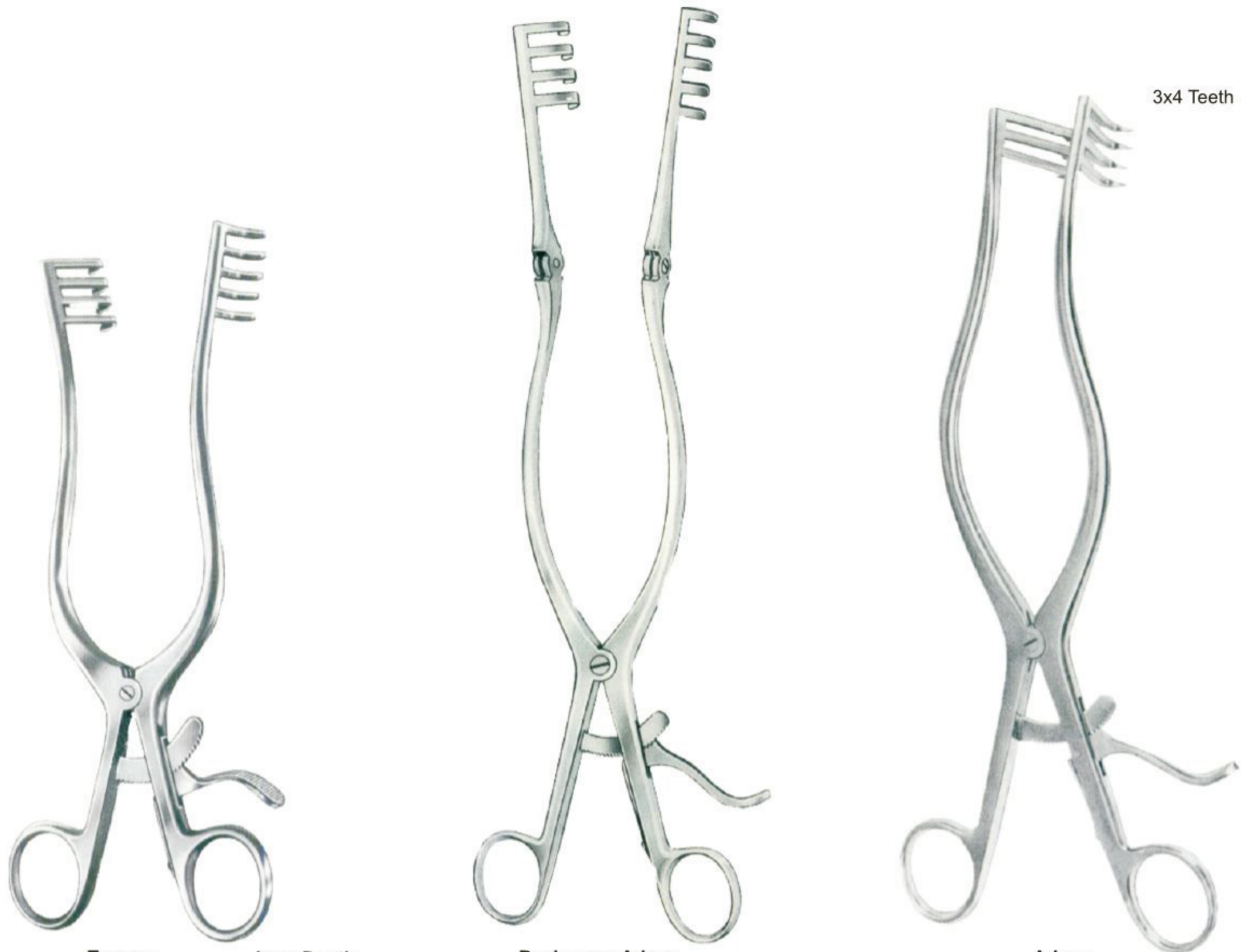

Travers
 11-3288-21
 21 cm/8¼"

Jaws Depth

Beckmann-Adson
 31 cm/12¼"

Adson
 27 cm/10½"

	Sharp	Blunt	Sharp	Blunt
25 mm	11-3289-01	11-3290-01	11-3291-27	11-3292-27
44 mm	11-3289-02	11-3290-02		

5x6 Teeth



Adson
 Sharp 11-3293-27 27cm/10½"
 Blunt 11-3294-27



Beckmann-Adson (Standard)
 Sharp 11-3295-31 31cm/12¼"
 Blunt 11-3296-31



Adson
 11-3297-33 33cm/13"

Hemilaminectomy Retractor



11-3298-27
 27cm/10½"



Beckmann-Eaton
 11-3299-33
 33 cm/13"

Retractor Only 11-3300-01 Lateral Blades 11-3300-02

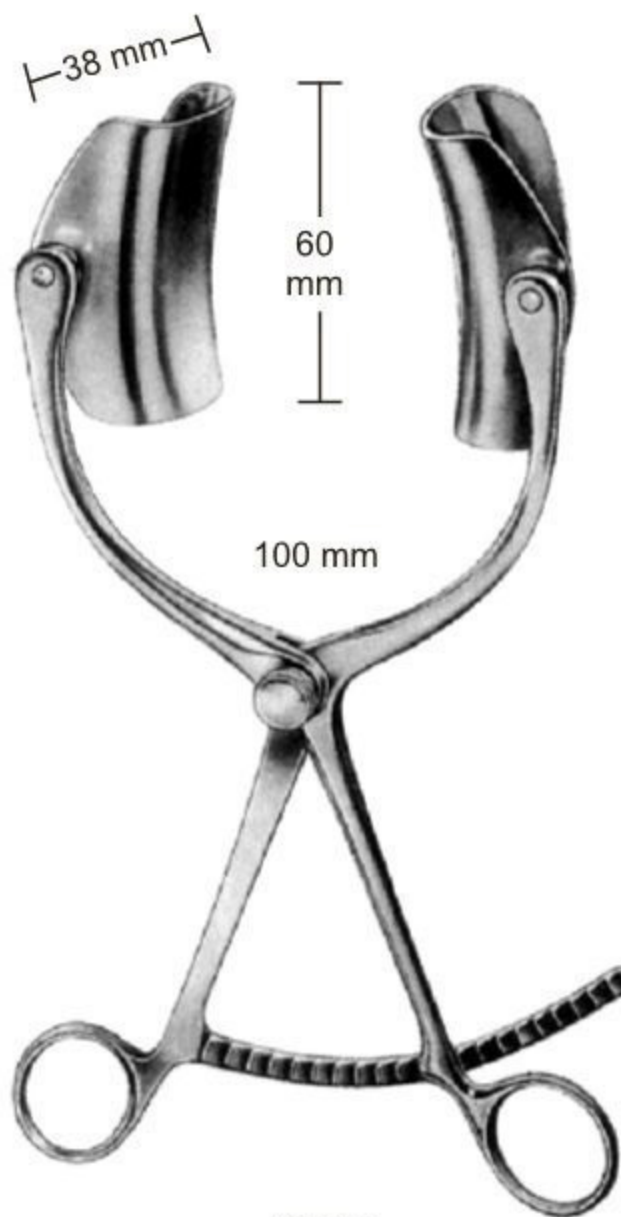

Collin
 11-3300-00
 20cm/8"

EN —● Ophthalmologie. Ophthalmology, Oftalmoloia
 DE —● Keratoplastikmesser, Stanzen Meibel
 ES —● Keratoplastikmesser, Stanzen Meibel

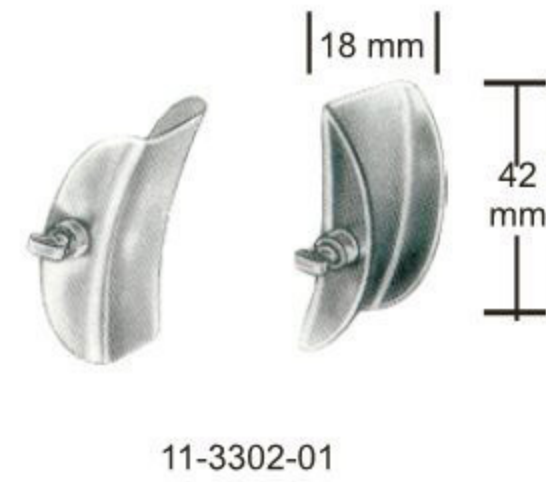
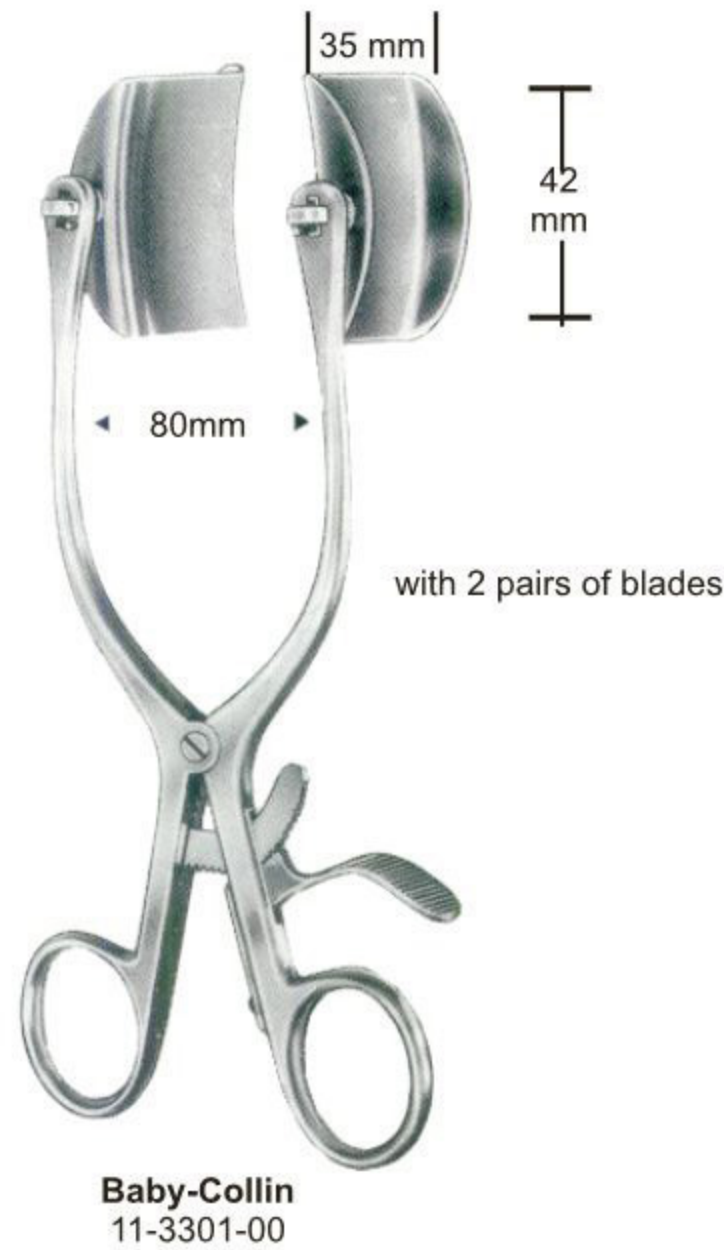
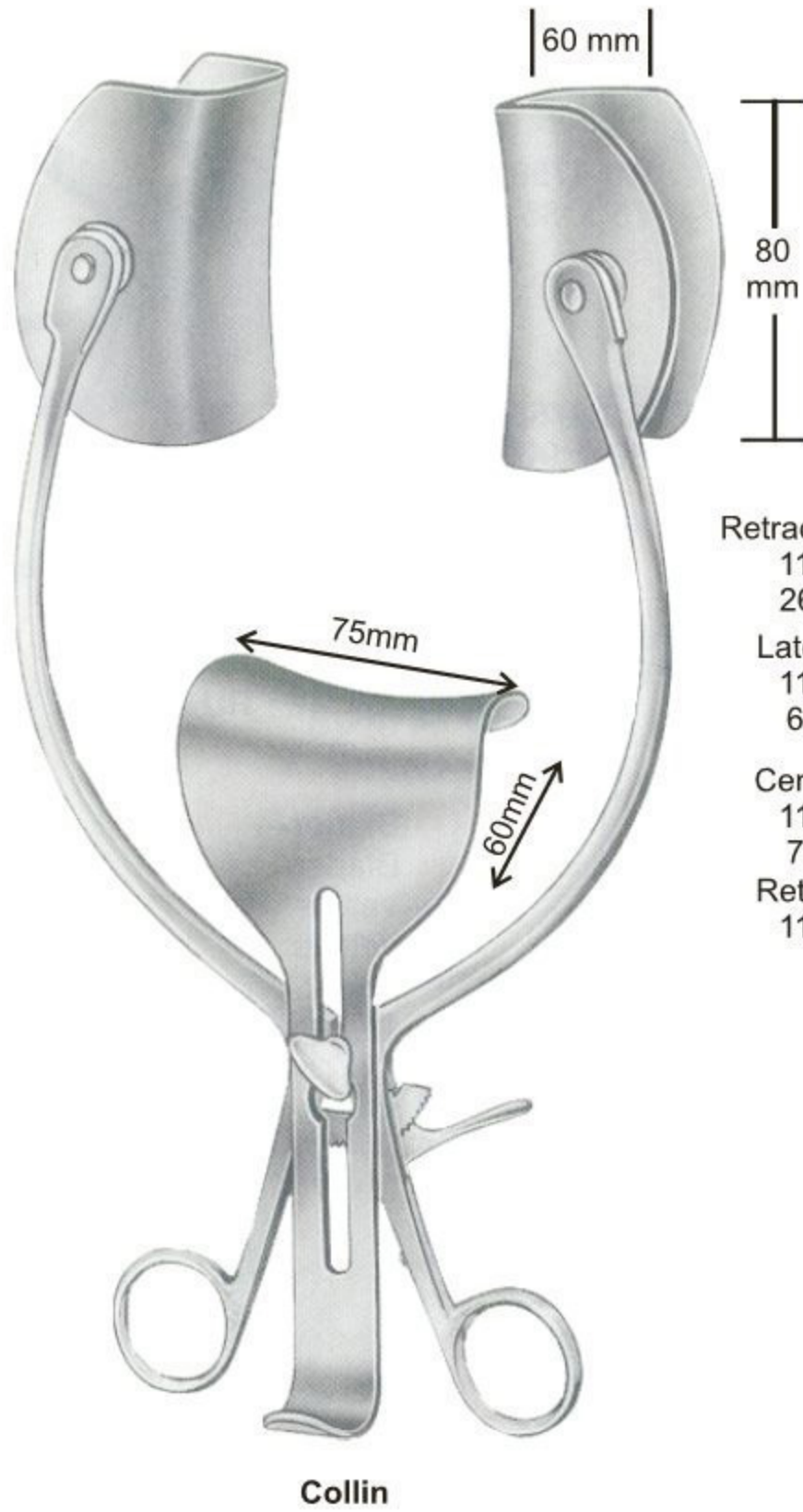

	Fig. 1 11-3303-00	Fig. 2 11-3304-00	Fig. 3 11-3305-00
Retractors Complete	11-3303-00	11-3304-00	11-3305-00
Retractors Only	11-3303-01	11-3304-01	11-3305-01
Lateral Blades	11-3303-02 38x62 mm	11-3304-02 38x80 mm	11-3305-02 38x100 mm
Central Blades	11-3303-03 55x55 mm		11-3305-03 55x75 mm

Ophthalmologie. Ophthalmology, Oftalmoloia ●— EN
 Keratoplastikmesser, Stanzen Meibel ●— DE
 Keratoplastikmesser, Stanzen Meibel ●— ES



Retractor Complete
 11-3306-00
 26cm/10½"
 Lateral Blades
 11-3306-01
 60X80mm
 Central Blades
 11-3306-02
 75X60mm
 Retractor Only
 11-3306-03



Mayo-Adams
 11-3307-01
 17cm/6¾"



Mayo-Adams
 11-3307-02
 17cm/6¾"

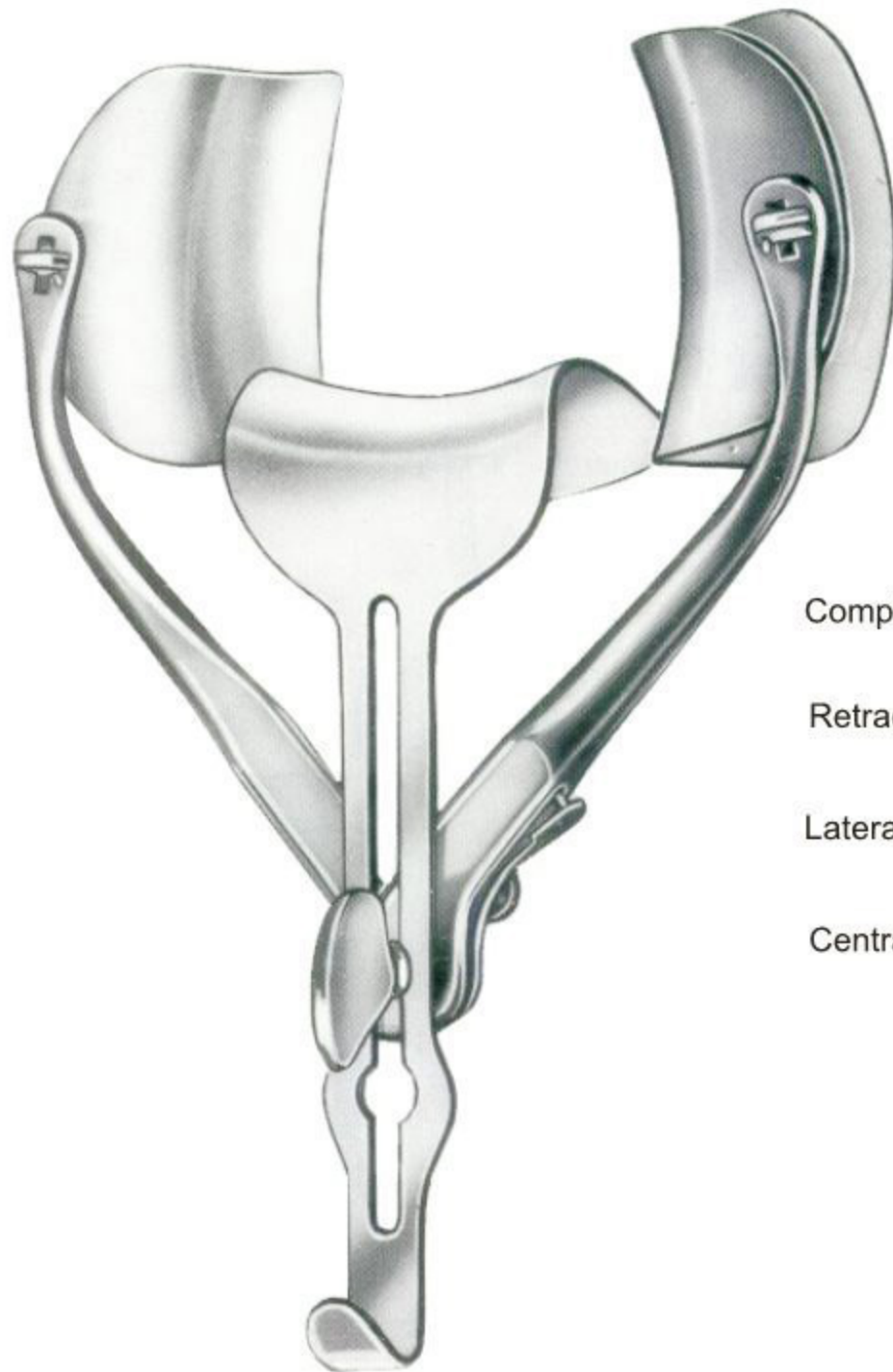

Ricard
 11-3308-00 28cm/11"
 11-3308-00 30cm/12"

Complete	Fig. 1 11-3309-00	Fig. 2 11-3310-00
Retractors Only	11-3309-01	11-3310-01
Lateral Blades	11-3309-02 60x80 mm	11-3310-02 75x85 mm
Central Only	11-3309-03 53x70 mm	11-3310-03 80x90 mm

Vulval Retractor



Richter
 11-3310-16
 16.5 cm/6½"



Gelpi
 11-3311-09 9 cm/3½"
 11-3311-11 11 cm/4½"
 11-3311-13 13 cm/5"
 11-3311-19 19 cm/7½"



Gelpi
 11-3312-19
 19 cm/7½"



Meyerding
 Fig. 1 11-3313-01
 Fig. 2 11-3313-02
 Fig. 3 11-3313-03
 Fig. 4 11-3313-04
 18 cm/7"

Blades

- Fig. 1 1¾"x1"
- Fig. 2 2⅛"x1"
- Fig. 3 2⅜"x1¾"
- Fig. 4 2⅜"x1"



Markham-Meyerding

11-3314-18 18cm/7" 11-3315-18

Rigby

11-3316-19
 19cm/7½"

De Bakey

11-3317-12 12cm/4 ¾"
 11-3317-17 17cm/6 ¾"

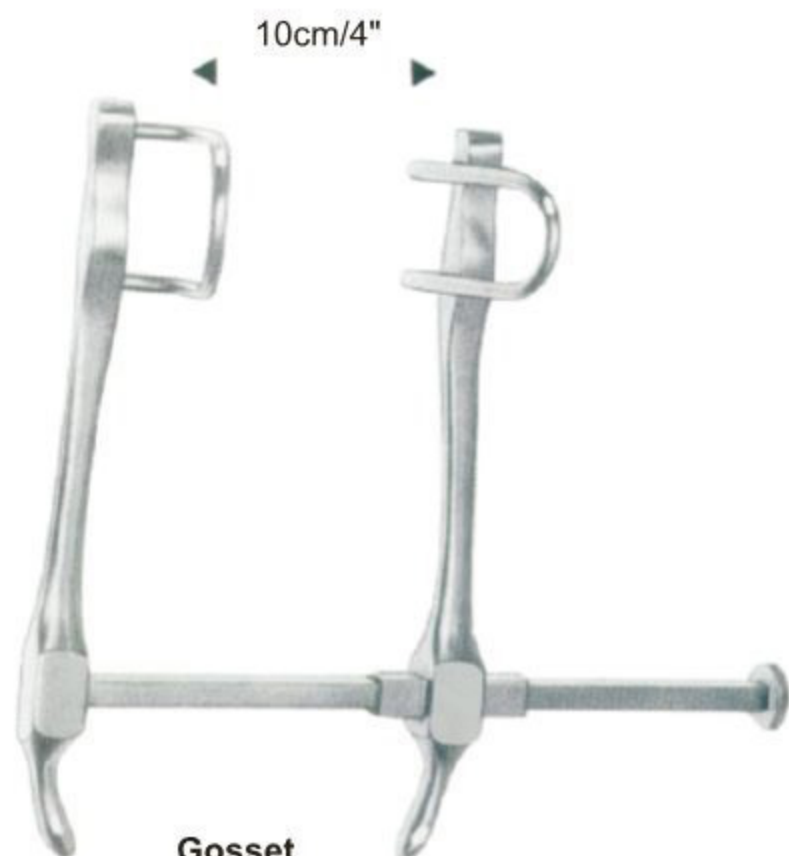

Gosset
 11-3318-00

Fig.1 ◀ 10cm/4" ▶
 Fig.2 ◀ 14cm/5½" ▶



Gosset
 Fig.1 11-3319-01
 Fig.2 11-3319-02



Gosset
 11-3320-00

Retractors Only
 11-3320-01

Central Blade
 11-3320-02
 56X60mm



Hertzler
 11-3321-00

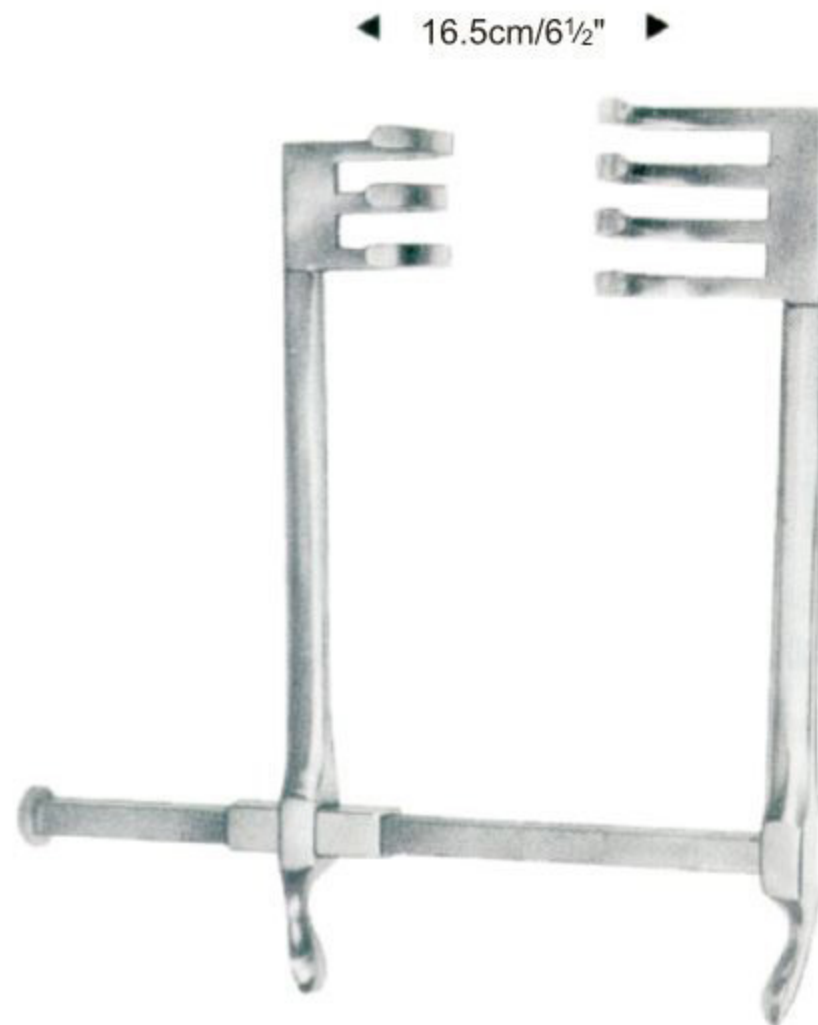

Frazier
 11-3322-00

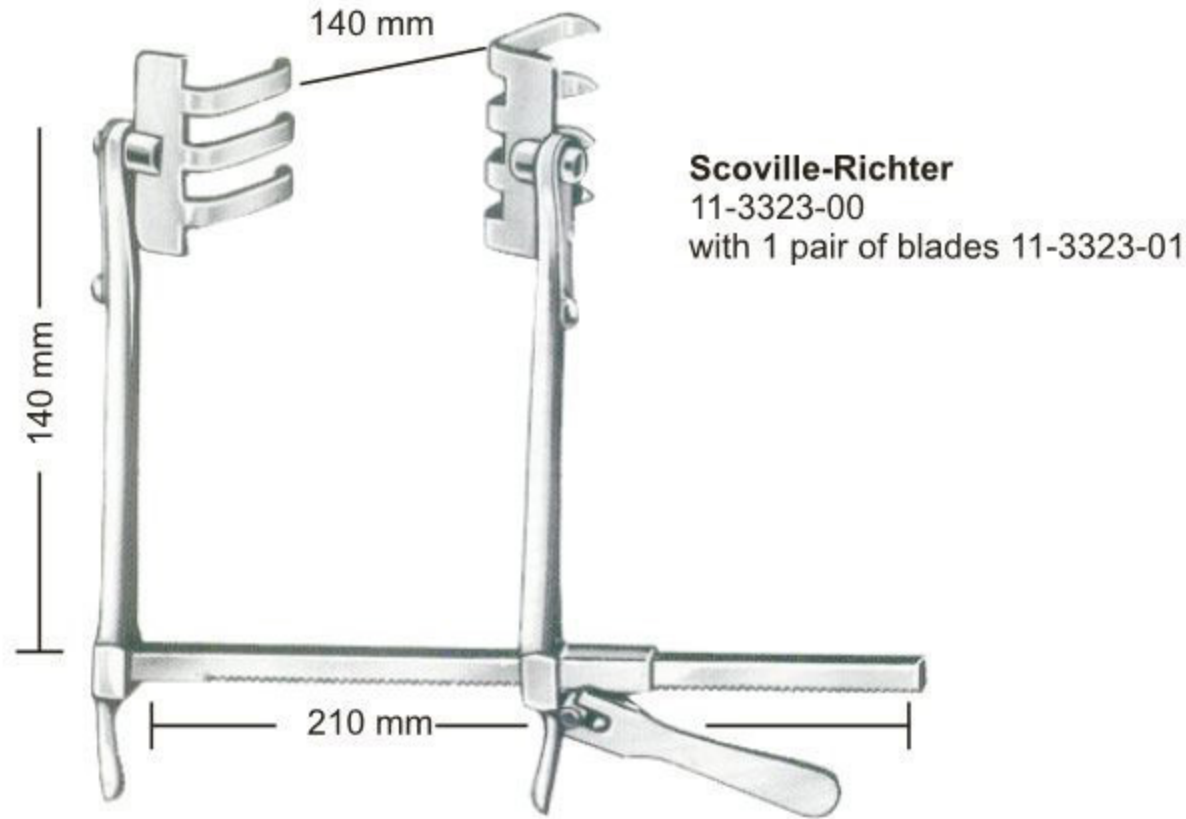

the blades are available by pairs

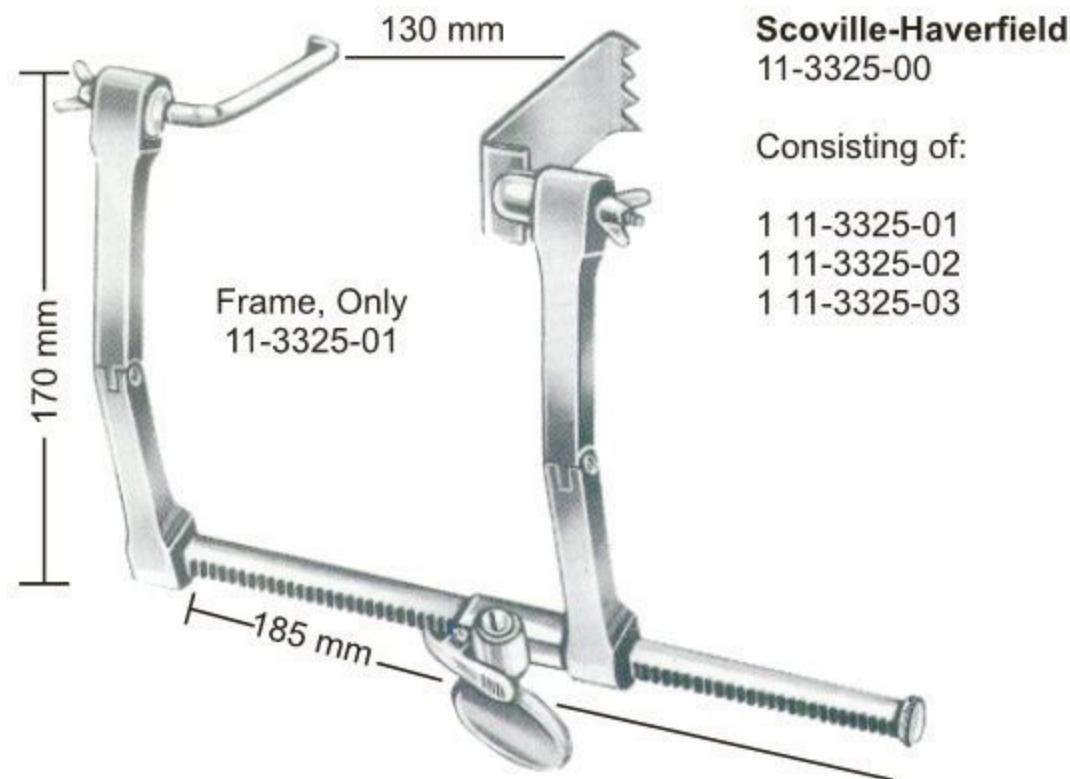
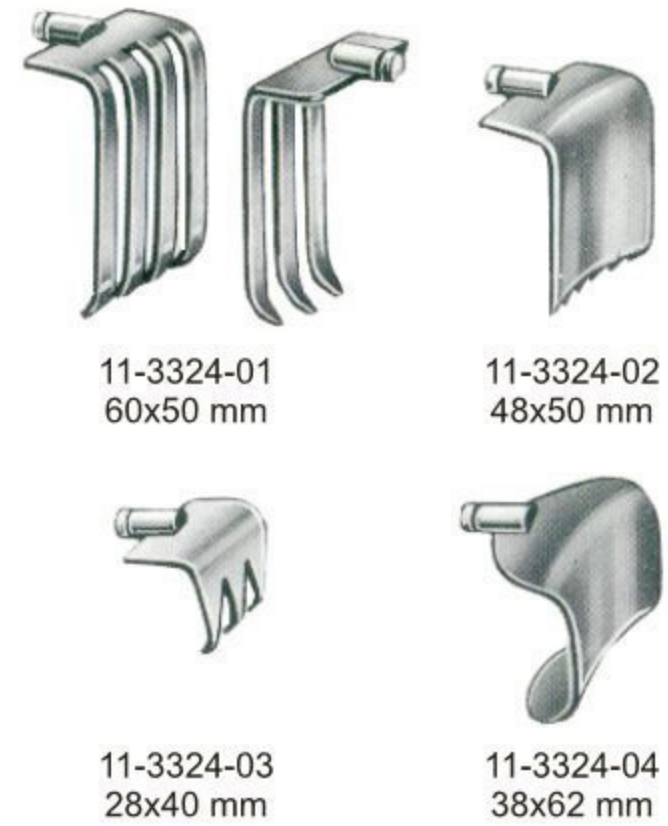

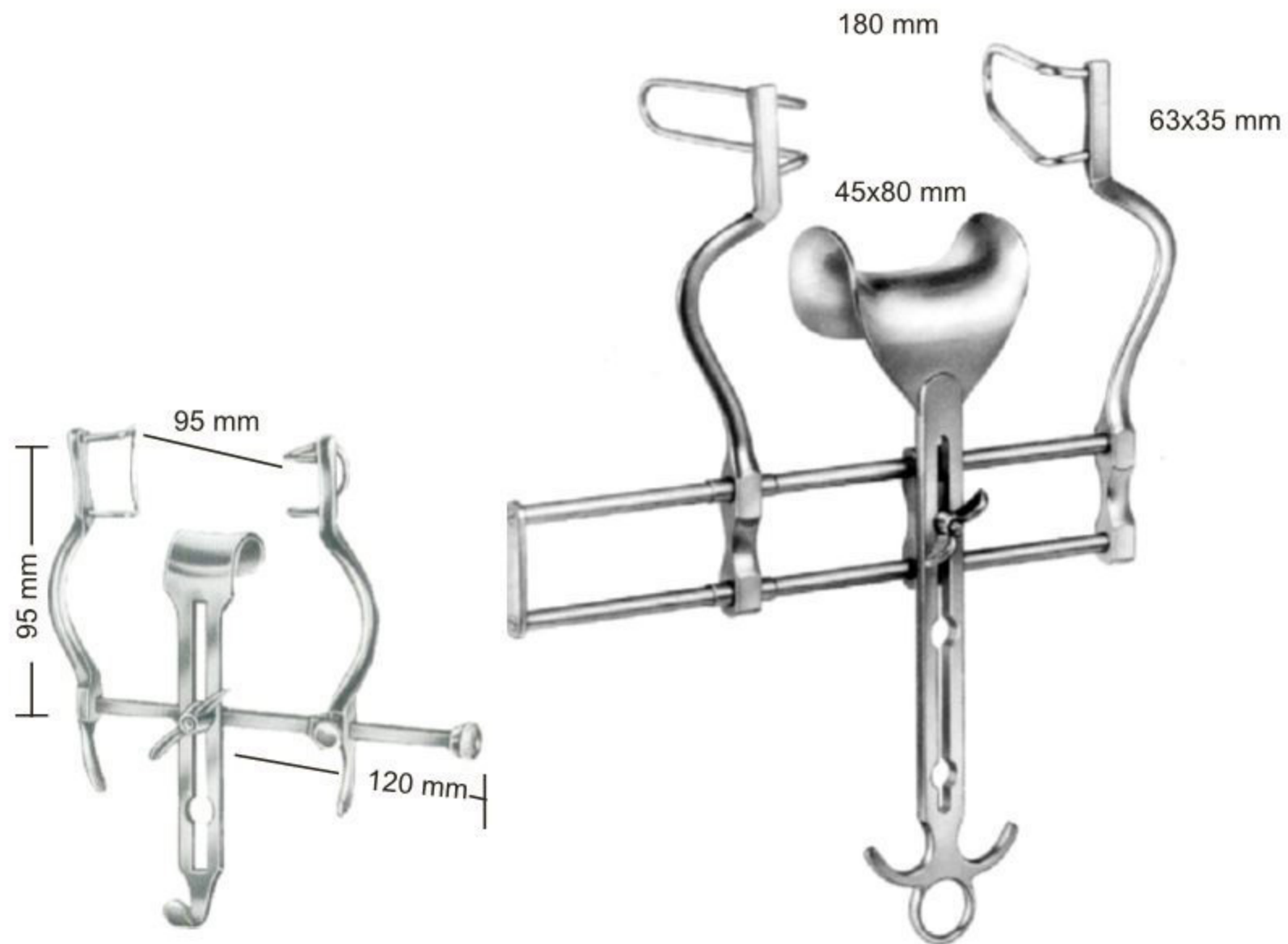

	Baby-Balfour 11-3327-00	Balfour 11-3328-00
Retractor Complete		
Retractor Only	11-3327-01	11-3328-01
Central Blade Only	11-3327-02	11-3328-02

Abdominal Retractors ● EN
 Bauchdeckenhalter ● DE
 Separadores abdominales ● ES



Retractor Complete
11-3329-00

Retractor Only
11-3329-01

Central Blade Only
11-3329-02

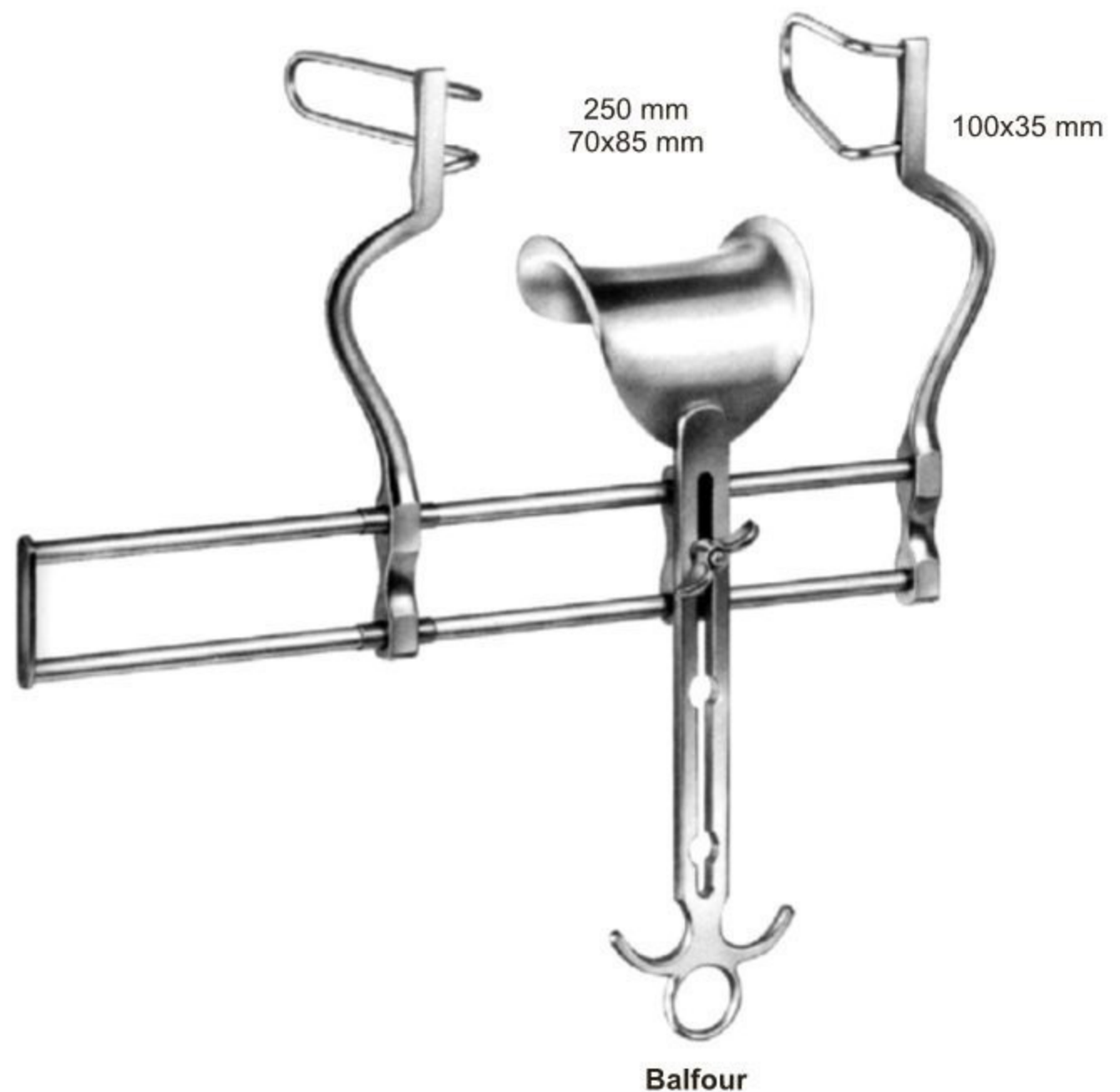

Retractor, Complete
11-3330-00

Retractor Only
11-3330-01

Central Blade Only
11-3330-02

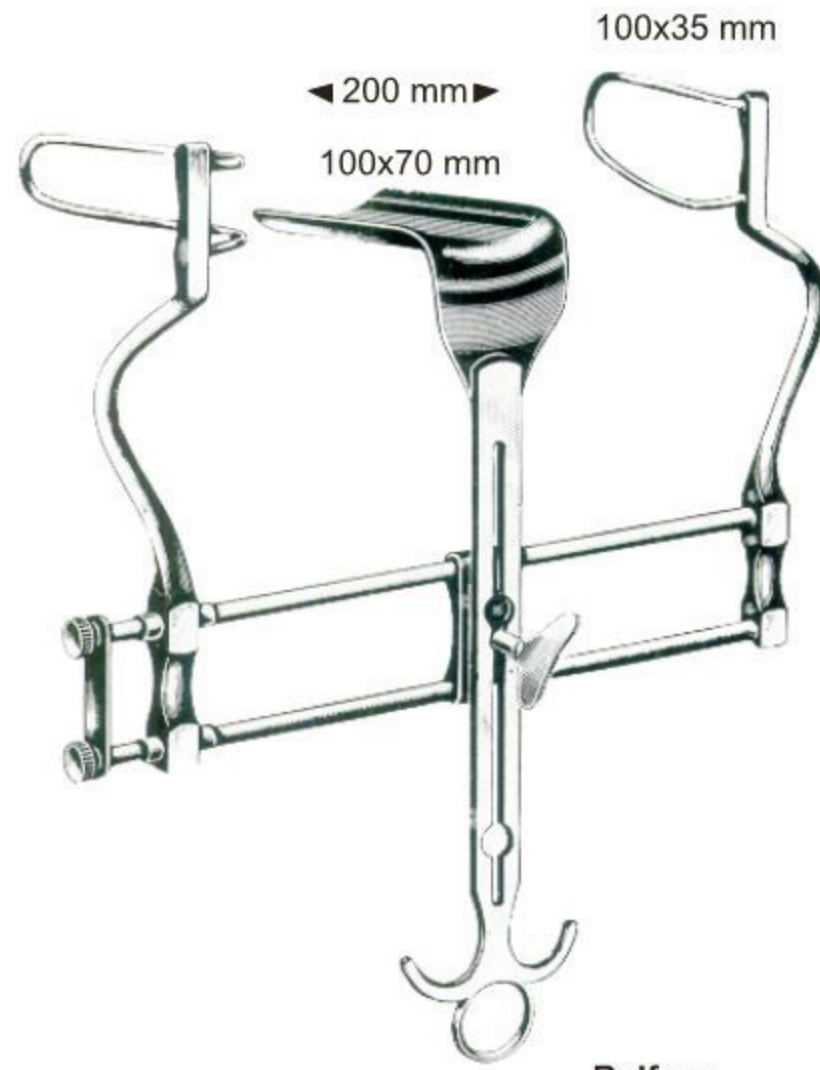

Balfour

Retractor, complete
 11-3331-00
 Retractor, only
 11-3331-01
 Central blade, only
 11-3331-02

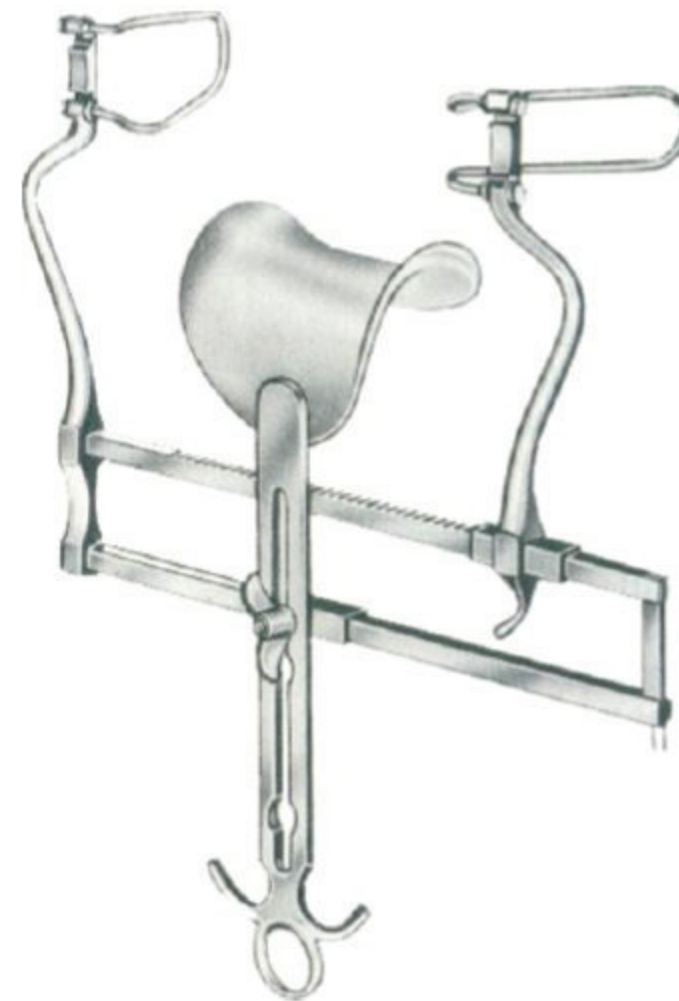

Balfour USA-Modell

Retractor, complete	
11-3332-00	
<hr/>	
Retractor, only	
11-3332-01	
<hr/>	
Central blade, only	
11-3332-02	11-3332-03
45x68 mm	68x85 mm
<hr/>	
Lateral blades, only	
11-3332-04	11-3332-05
60 mm	80 mm

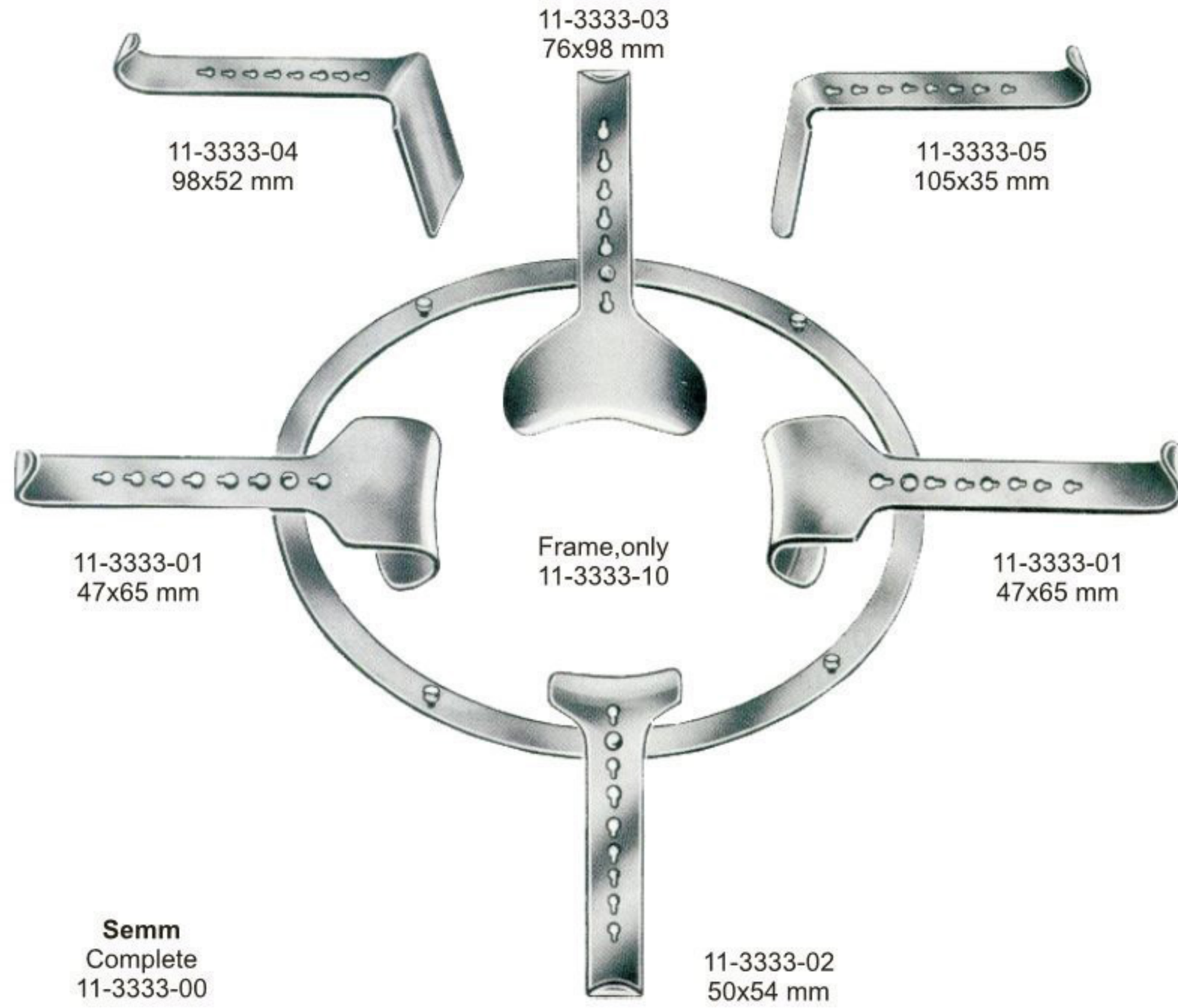

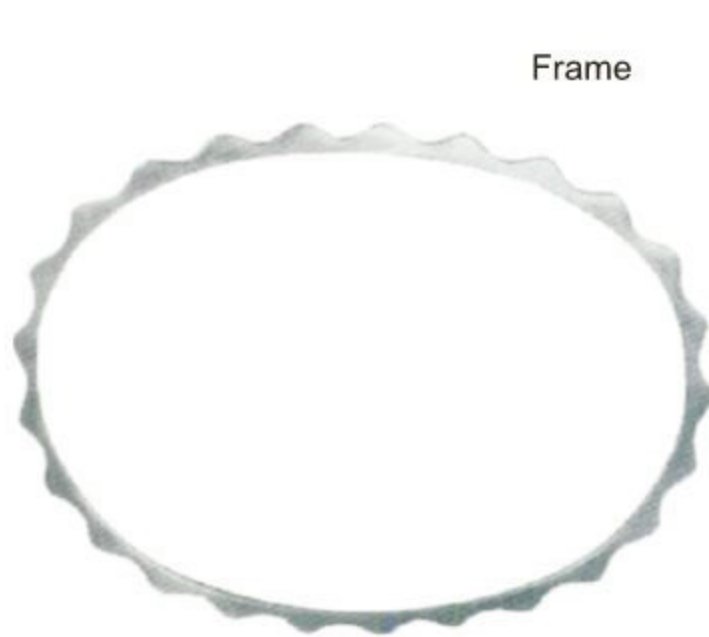

Frame

11-3337-10 178x140 mm
 11-3338-20 255x178 mm



Fig.1 11-3337-01 38x38 mm
 Fig.2 11-3338-02 38x25 mm

Complete
 11-3337-00
 11-3338-00

Denis-Brown
 Consisting of

1x 11-3337-10
 1x 11-3338-20

2x 11-3337-01
 2x 11-3338-01

2x 11-3337-02
 2x 11-3338-02



110x70 mm

O'Sullivan-O'Connor
 Complete
 11-3339-00



11-3339-01
 80x45 mm



11-3339-02
 80x45 mm



11-3339-03
 110x70 mm

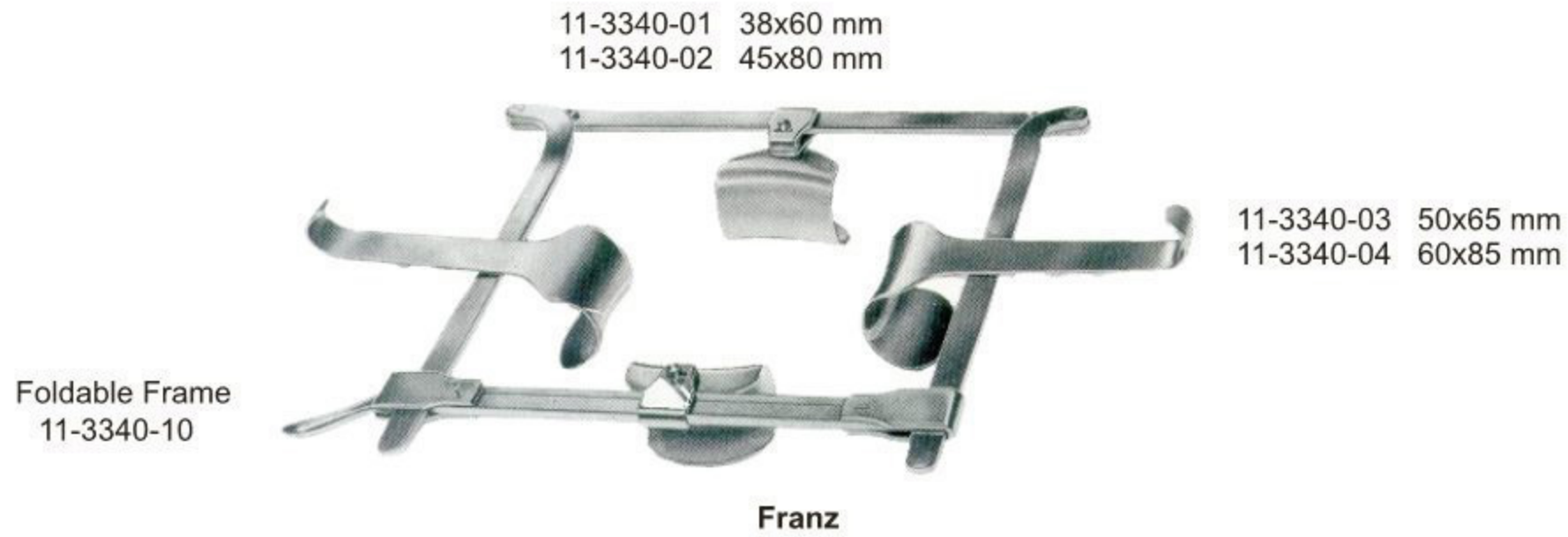

Complete with 4 valves 11-3340-00	With con	11-3340-10 1x 11-3340-01 2x 11-3340-03 2x
Complete with 8 valves 11-3341-00	With con	11-3340-10 1x 11-3340-01 2x 11-3340-02 2x 11-3340-03 2x 11-3340-04 2x



- EN** Bone Surgery
- DE** Knochenchirurgie
- ES** Cirugía ósea

Page 243 to 314





Mead
 12-3501-17 17.0cm
 26mm Ø, 320 g (11¼ oz)



Parsch
 12-3502-18 18.0cm
 22mm Ø, 200 g (7 oz)



12-3503-30
 30mm Ø, 510 g



12-3504-25 250 g
 12-3505-45 450 g
 12-3506-90 900 g
 26.5cm



12-3507-18 18.5cm
 25mm Ø 135 g



lead filled

12-3508-19 19.0cm
 22mm Ø 155 g



Hajek
 12-3509-22 22.0cm
 27mm Ø 130 g

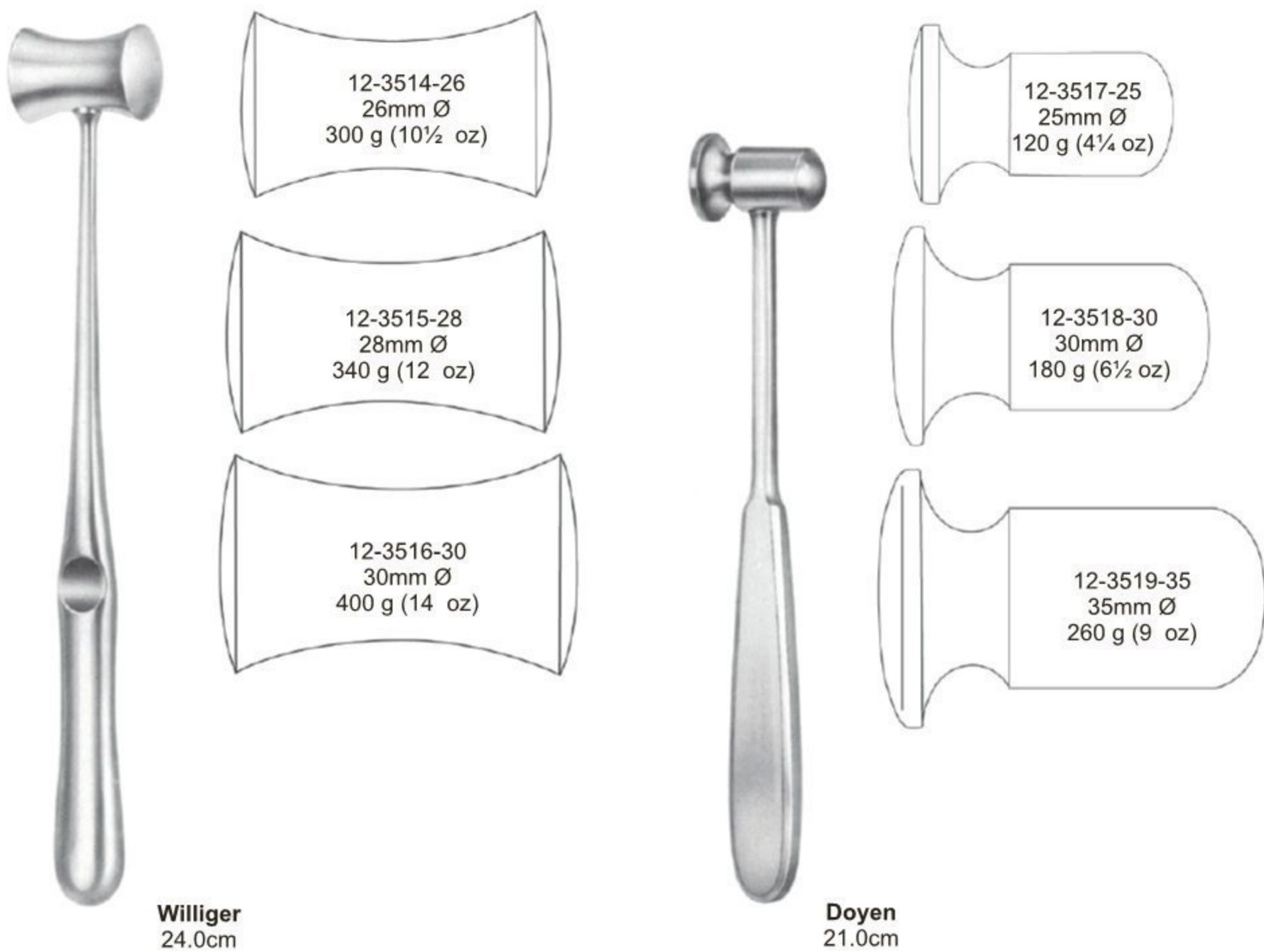
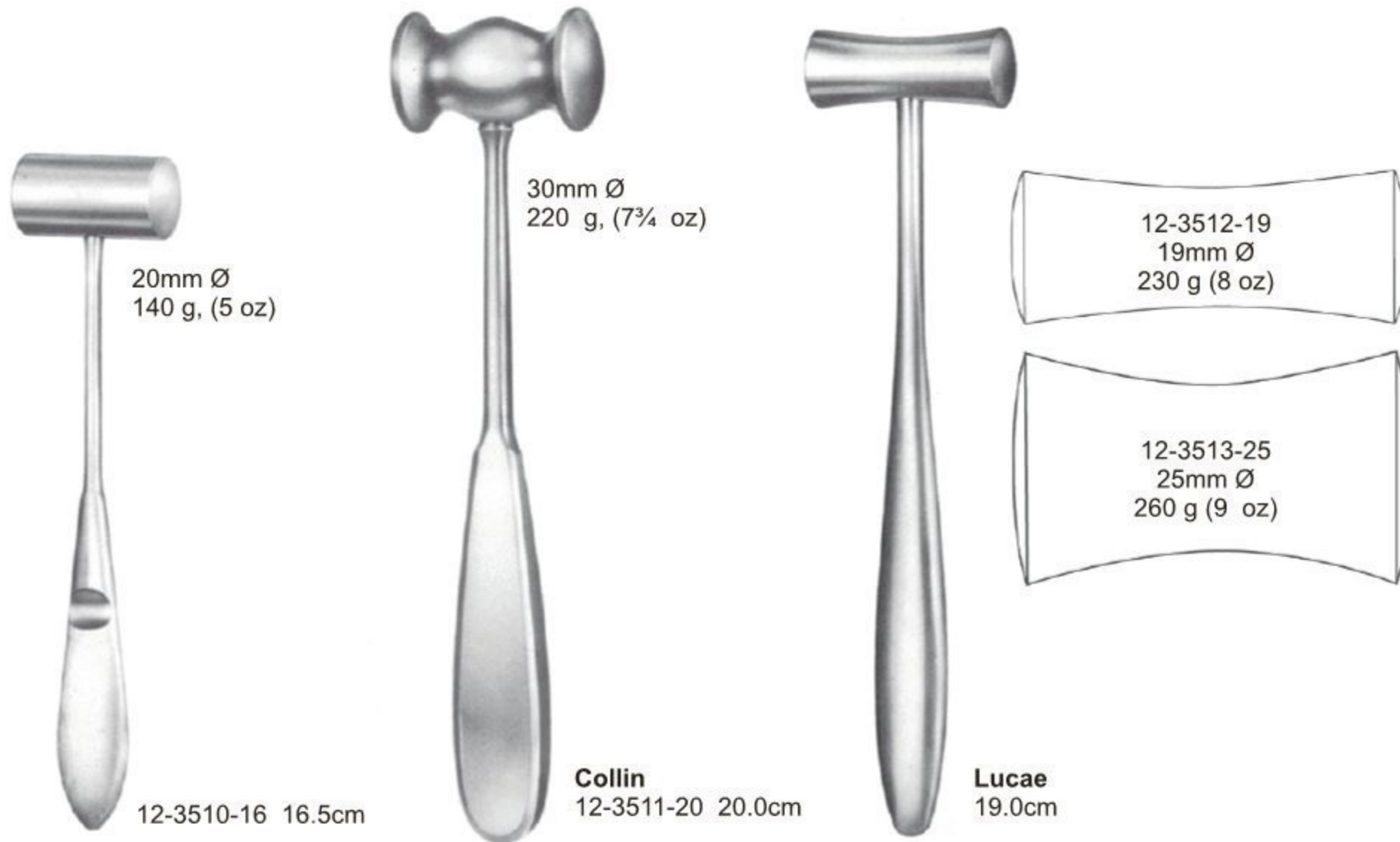



Gerzog
 12-3520-18 18.0cm
 250 g

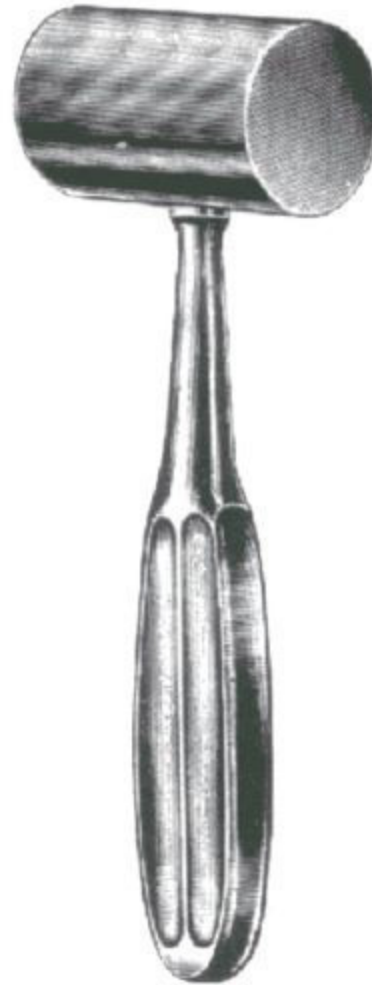

Kirk
 12-3521-19 19.0cm
 750 g

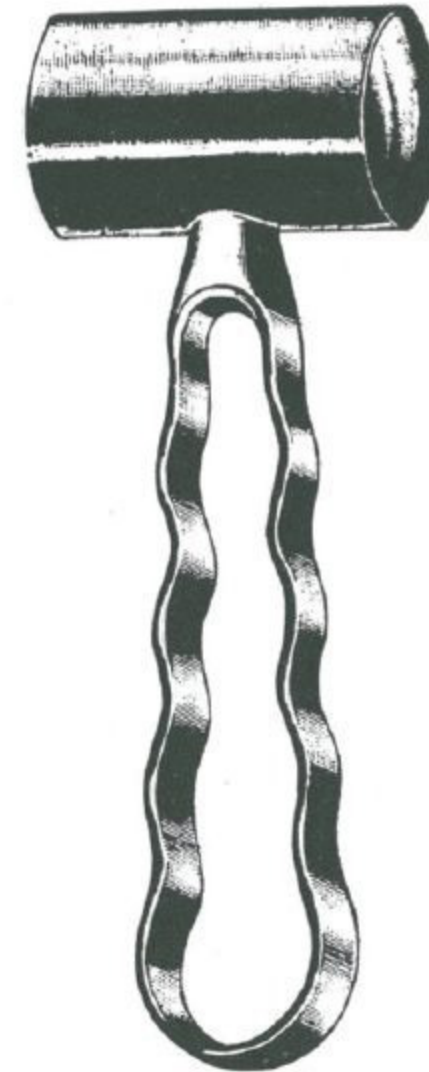

Heath
 18.0cm
 12-3522-35 35mm Ø (28 oz)
 12-3522-40 40mm Ø (36 oz)



12-3523-26
 26.5cm 530 g (19 oz)



12-3524-24
 24.0cm (30mm Ø 480 g)



12-3525-22
 22.5cm (37mm Ø 370 g)



12-3526-24 24.0cm

Mallets ● EN
 Hämmer ● DE
 Martillos y Mazos ● ES



12-3527-26 26.5cm
 30mm Ø, 510 g (18 oz)



12-3528-26 26.5cm



12-3529-25 26.5cm 250 g (0.55 lbs)
 12-3529-45 26.5cm 450 g (1 lbs)
 12-3529-90 26.5cm 900 g (2 lbs)



mm **Partsch**
 02 12-3530-02
 03 12-3530-03
 04 12-3530-04
 05 12-3530-05
 06 12-3530-06
 07 12-3530-07
 08 12-3530-08
 13.5 cm/5¼"



mm **Partsch**
 12-3531-02
 12-3531-03
 12-3531-04
 12-3531-05
 12-3531-06
 12-3531-07
 12-3531-08
 17 cm/6¾"

mm **Partsch**
 12-3532-02
 12-3532-03
 12-3532-04
 12-3532-05
 12-3532-06
 12-3532-07
 12-3532-08
 13.5 cm/5¼"

mm
 12-3533-04
 12-3533-06
 12-3533-08
 12-3533-10
 12-3533-12
 12-3533-14
 12-3533-16
 17cm/6¾"



Width

mm
 04 12-3534-04 12-3535-04 12-3536-04
 06 12-3534-06 12-3535-06 12-3536-06
 08 12-3534-08 12-3535-08 12-3536-08
 10 12-3534-10 12-3535-10 12-3536-10
 12 12-3534-12 12-3535-12 12-3536-12
 14 12-3534-14 12-3535-14 12-3536-14
 16 12-3534-16 12-3535-16 12-3536-16
 13.5 cm/5¼"



mm
 06 12-3537-06
 12 12-3537-12
 18 12-3537-18



Mod. USA
 12-3538-06
 12-3538-12
 12-3538-18
 16 cm/6¼"



12-3539-06
 12-3539-12
 12-3539-18



16 cm/6¼"

12-3540-03
 3mm
 12-3540-05
 5mm
 12-3540-07
 7mm
 212-3540-09
 9mm



Passow
 12 cm/4¾"

12-3541-02
 2.5mm
 12-3541-03
 3.5mm



Lexer
 27.5 cm/10¾"

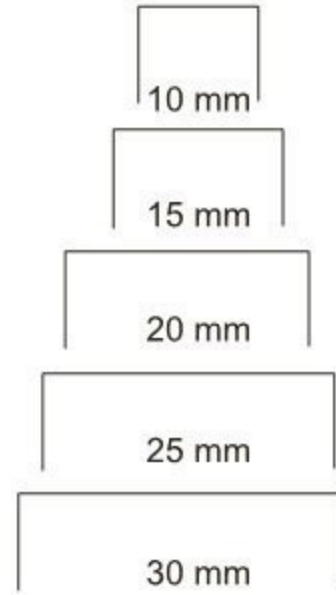

- 12-3542-10
- 12-3542-15
- 12-3542-20
- 12-3542-25
- 12-3542-30

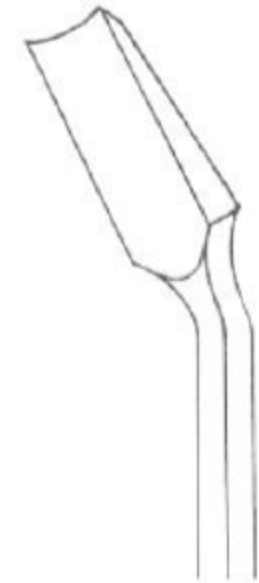

- 12-3543-10
- 12-3543-15
- 12-3543-20
- 12-3543-25
- 12-3543-30



Cloward
 24 cm/9½"

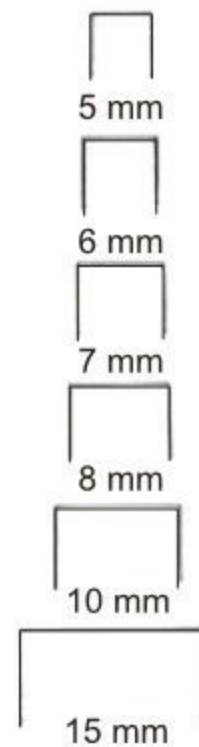

- 12-3544-05
- 12-3544-06
- 12-3544-07
- 12-3544-08
- 12-3544-10
- 12-3544-15



- 12-3545-05
- 12-3545-06
- 12-3545-07
- 12-3545-08
- 12-3545-10
- 12-3545-15



Alexander
 18 cm/7"

	mm
12-3546-04	04
12-3546-06	06
12-3546-08	08
12-3546-10	10
12-3546-12	12
12-3546-14	14



12-3547-04
12-3547-06
12-3547-08
12-3547-10
12-3547-12
12-3547-14



Hoke

14 cm/5½"

	mm
12-3548-02	2
12-3548-03	3
12-3548-04	4
12-3548-05	5
12-3548-06	6
12-3548-07	7
12-3548-08	8

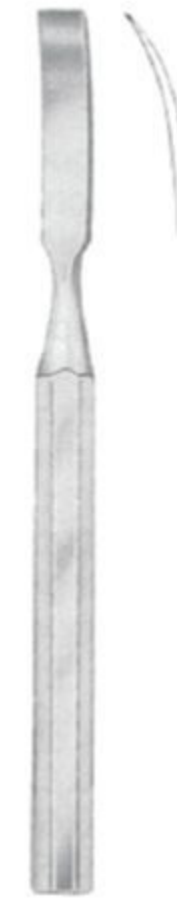

12-3549-02
12-3549-03
12-3549-04
12-3549-05
12-3549-06
12-3549-07
12-3549-08



Smith-Petersen
 20 cm/8"



mm				
06	12-3550-06	12-3551-06	12-3552-06	12-3553-06
09	12-3550-09	12-3551-09	12-3552-09	12-3553-09
13	12-3550-13	12-3551-13		
14			12-3552-14	12-3553-14
16	12-3550-16	12-3551-16	12-3552-16	12-3553-16
19	12-3550-19	12-3551-19	12-3552-19	12-3553-19
25	12-3550-25	12-3551-25	12-3552-25	12-3553-25
32	12-3550-32	12-3551-32	12-3552-32	12-3553-32



Lambotte
 mm
 12-3554-04 04 12-3555-04
 12-3554-06 06 12-3555-06
 12-3554-08 08 12-3555-08
 12-3554-10 10 12-3555-10
 12-3554-13 13 12-3555-13
 12-3554-16 16 12-3555-16
 12-3554-18 18 12-3555-18
 12-3554-20 20 12-3555-20
 12-3554-25 25 12-3555-25
 12-3554-30 30 12-3555-30
 12-3554-38 38 12-3555-38
 12-3554-44 44 12-3555-44
 12-3554-50 50 12-3555-50

24 cm/9½"

Curved



23 cm/9"



Mini-Lambotte
 mm
 12-3556-02 02 12-3557-02
 12-3556-03 03 12-3557-03
 12-3556-04 04 12-3557-04
 12-3556-06 06 12-3557-06
 12-3556-08 08 12-3557-08
 12-3556-10 10 12-3557-10
 12-3556-12 12 12-3557-12
 12-3556-15 15 12-3557-15
 12.5 cm/5" 17 cm/6¾"



Mini-Lexer
 mm
 12-3558-04 04 12-3559-04
 12-3558-06 06 12-3559-06
 12-3558-08 08 12-3559-08
 12-3558-10 10 12-3559-10
 12-3558-12 12 12-3559-12

18 cm/7"



Lexer
 mm
 12-3560-05 05 12-3561-05
 12-3560-07 07 12-3561-07
 12-3560-10 10 12-3561-10
 12-3560-15 15 12-3561-15
 12-3560-20 20 12-3561-20
 12-3560-25 25 12-3561-25
 12-3560-30 30 12-3561-30

22 cm/8¾"





Chisel
12-3562-20
24.5 cm/9 3/4"
20 mm



Chisel-Curved
12-3563-20
26.5 cm/10 1/2"
20 mm

Gouge for the
removing of
broken screws



12-3564-22
22 cm/8 3/4"

Bone Chisels and Gauges ●— EN
 Meißel und Osteotome ●— DE
 Cinceles y Gubias para huesos ●— ES



Zielke
 23 cm/9"
 5.5 mm
 9.0 mm

12-3565-05
 12-3565-09



Width

mm	12-3566-06	12-3567-06	12-3568-06	12-3569-06	12-3570-06
06	12-3566-06	12-3567-06	12-3568-06	12-3569-06	12-3570-06
08	12-3566-08	12-3567-08	12-3568-08	12-3569-08	12-3570-08
10	12-3566-10	12-3567-10	12-3568-10	12-3569-10	12-3570-10
12	12-3566-12	12-3567-12	12-3568-12	12-3569-12	12-3570-12
15	12-3566-15	12-3567-15	12-3568-15	12-3569-15	12-3570-15
20	12-3566-20	12-3567-20	12-3568-20	12-3569-20	12-3570-20
25	12-3566-25	12-3567-25	12-3568-25	12-3569-25	12-3570-25
30	12-3566-30	12-3567-30	12-3568-30	12-3569-30	12-3570-30

Stille
 20 cm/8"



mm	12-3571-06	12-3572-06	12-3573-06	12-3574-06	12-3575-06
06	12-3571-06	12-3572-06	12-3573-06	12-3574-06	12-3575-06
09	12-3571-09	12-3572-09	12-3573-09	12-3574-09	12-3575-09
13	12-3571-13	12-3572-13	12-3573-13	12-3574-13	12-3575-13
16	12-3571-16	12-3572-16	12-3573-16	12-3574-16	12-3575-16
19	12-3571-19	12-3572-19	12-3573-19	12-3574-19	12-3575-19
25	12-3571-25	12-3572-25	12-3573-25	12-3574-25	12-3575-25
32	12-3571-32	12-3572-32	12-3573-32	12-3574-32	12-3575-32

Hibbs
 24 cm/9½"



12-3579-01

12-3579-02



12-3579-03

Cobb
28 cm/11"

12-3579-04

mm **Lexer**
 05 12-3576-05
 10 12-3576-10
 15 12-3576-15
 28 cm/11"

Lexer
 12-3577-05
 12-3577-10
 12-3577-15
 25 cm/10"

Lexer
 12-3578-05
 12-3578-10
 12-3578-15
 25 cm/10"

Bone Files ● EN
 Knochenfeile ● DE
 Lima para huesos ● ES



Putti
 12-3580-30
 30 cm/12"



Putti
 12-3581-27
 27 cm/10½"



12-3582-25
 25 cm/10"



12-3583-24
 24 cm/9½"



12-3584-22
 22 cm/8¾"



Width

Lambotte
 21 cm/8¼"

	mm
12-3585-05	05
12-3585-10	10
12-3585-15	15
12-3585-20	20
12-3585-25	25



Schneider
 12-3586-17
 13 mm
 17.5 cm/7"



Schneider-Sauerbruch
 12-3587-19
 13 mm
 19 cm/7½"



Alexander
 12-3588-20
 20 cm/8"



Jansen
 12-3589-16
 15 mm
 16.5 cm/6½"



Seldin
 12-3590-19
 19 cm/7½"



Davidson-Alexander
 12-3591-29
 29 cm/11½"



Williger
 12-3592-29
 13 cm/5"

Periosteal Raspatories ● EN
 Raspatorien ● DE
 Legras-Periostótomos ● ES

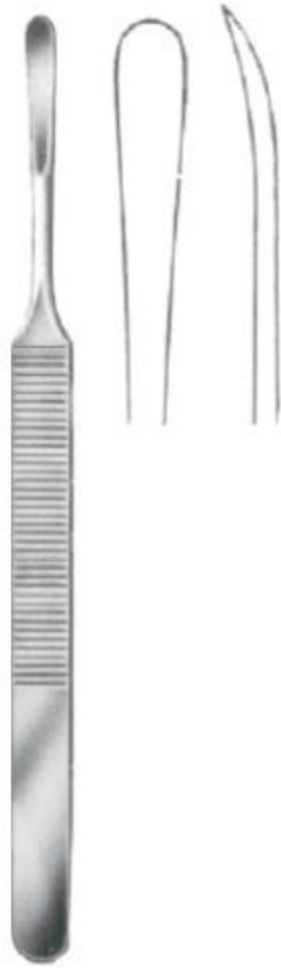

Konig
 12-3593-15
 15.5 cm/6"
 5 mm

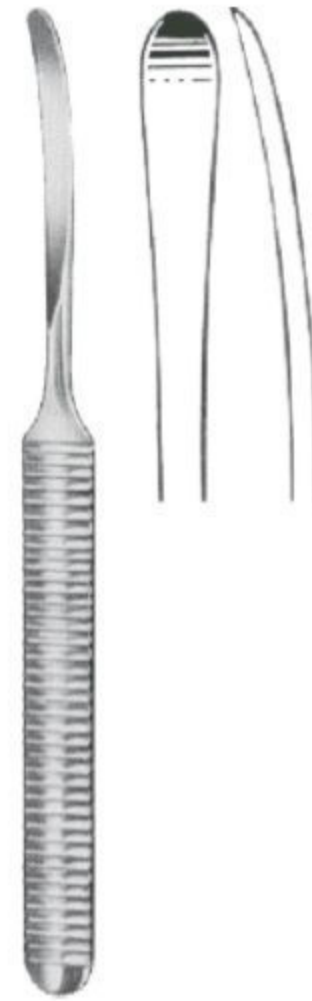

Williger
 12-3594-16
 16 cm/6¼"



Adson
 17 cm/6¾"



12-3595-01



12-3595-02



12-3595-03



12-3595-04



12-3596-06
 6 mm

17 cm/6¾"

12-3597-08
 8 mm

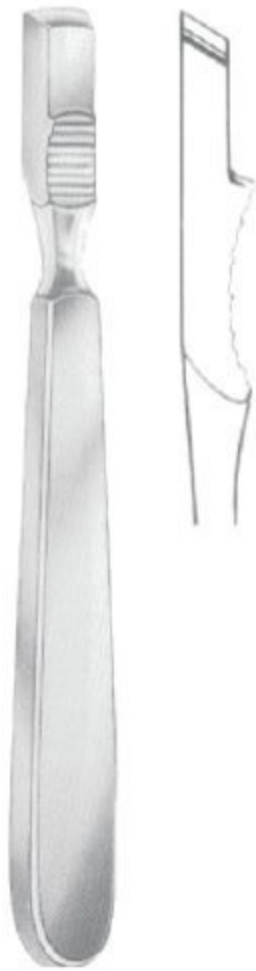

Farabeuf
 12-3598-15
 15 cm/6"



Farabeuf
 12-3599-15
 15 cm/6"



Farabeuf-Collin
 12-3600-15
 15.5 cm/6"
 11 mm



Farabeuf-Collin
 12-3601-15
 15.5 cm/6"
 11 mm



Farabeuf
 12-3602-19
 19 cm/7½"
 13 mm

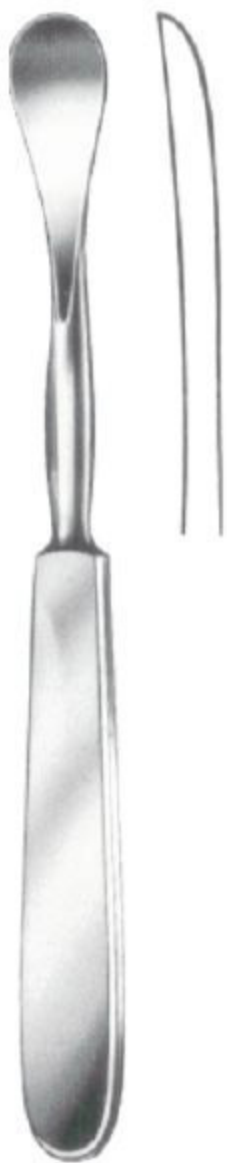

Sedillot
 12-3603-18
 18 cm/7"
 18 mm



Sedillot
 12-3604-21
 21 cm/8¼"
 15 mm



Langenbeck
 12-3605-19
 19 cm/7½"



Langenbeck
 12-3606-18
 18 cm/7"

Periosteal Raspatories ● EN
 Raspatorien ● DE
 Legras-Periostótomos ● ES



Overholt
 12-3607-29
 29.5 cm/11½"



Overholt
 12-3608-29
 29.5 cm/11½"



Overholt
 12-3609-28
 28.5 cm/11¼"



Hylin
 14.5 cm/5¾"



12-3610-01



12-3610-02



12-3610-03



Matson
 12-3611-22
 22 cm/8¾"



Semb



12-3612-01
 19.5 cm/7½"
 12 mm



12-3613-02
 19.5 cm/7½"
 12 mm



12-3614-03
 19.5 cm/7½"
 12 mm



12-3615-04
 22 cm/8¾"
 13 mm



12-3616-05
 21.5 cm/8½"
 13 mm



12-3617-06
 22 cm/8½"
 15 mm



12-3618-07
 22 cm/8½"
 15 mm



Doyen
 17 cm/6¾"

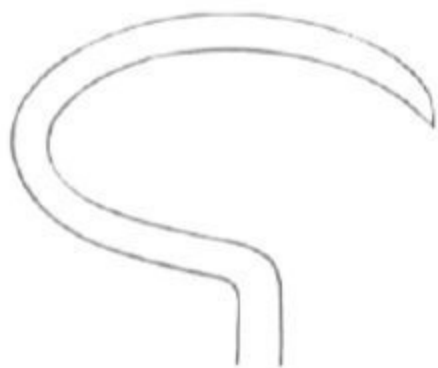

12-3619-01

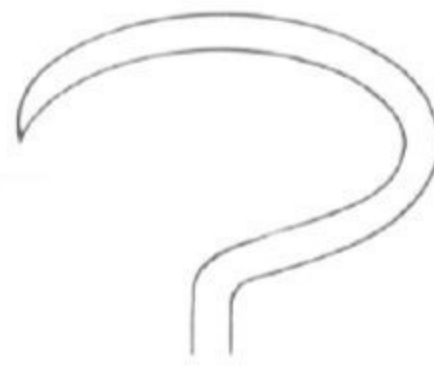

12-3619-02



12-3620-01



12-3620-02



12-3621-01



Doyen
 24 cm/9½"



12-3622-02

Periosteal Raspatories ● EN
 Raspatorien ● DE
 Legras-Periostótomos ● ES



12-3623-04
4 mm



12-3623-06
6 mm



12-3623-08
8 mm



Cobb
24 cm/9½"



12-3623-10
10 mm



12-3623-13
13 mm



12-3623-19
19 mm



12-3623-25
25 mm



12-3624-01
 19 cm/7½"
 6 mm



12-3625-02
 18.5 cm/7¼"
 3 mm



12-3626-03
 18.5 cm/7¼"
 6 mm



12-3627-04
 18.5 cm/7¼"
 6 mm

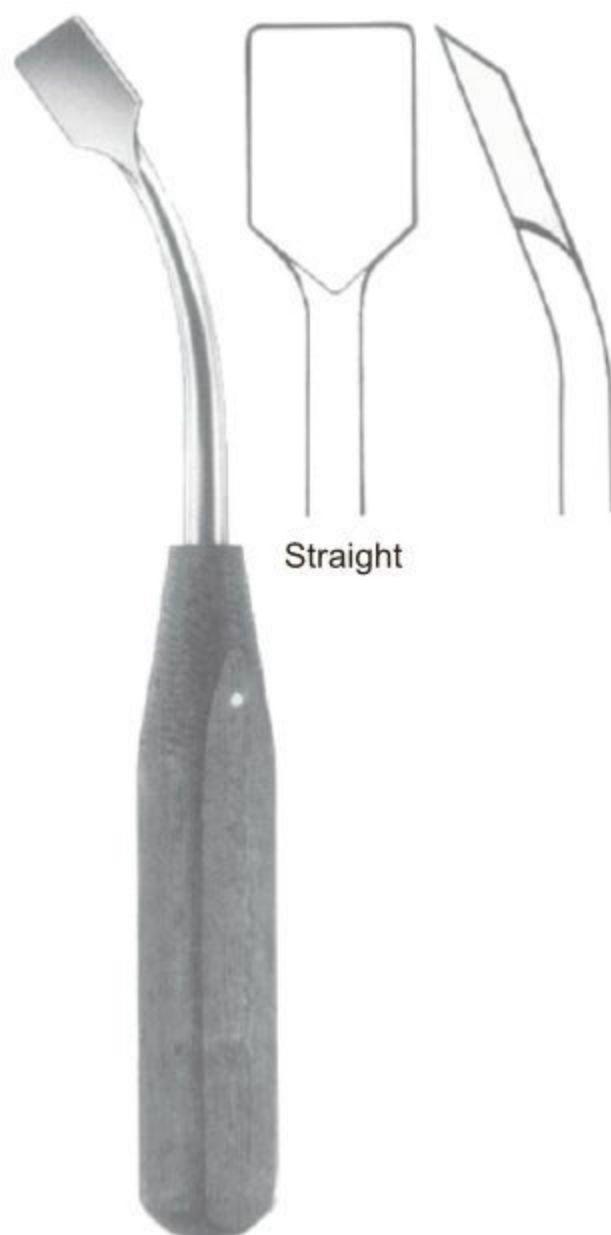

12-3628-05
 18.5 cm/7¼"
 13 mm



12-3629-06
 19.5 cm/7¾"
 14 mm



12-3630-07
 18.5 cm/7¼"
 14 mm



12-3631-08
 20 cm/8"
 20 mm

Periosteal Raspatories ● EN
 Raspatorien ● DE
 Legras-Periostótomos ● ES



12-3632-20
 27.5 cm/10¾"
 20 mm



Wagner
 8 mm 12-3633-08 33 cm/13"
 17 mm 12-3633-17 33 cm/13"



Cobb
 10 mm 12-3634-10 25 cm/10"
 13 mm 12-3634-13 25 cm/10"
 19 mm 12-3634-19 25 cm/10"
 25 mm 12-3634-25 25 cm/10"



Cobb
 10 mm 12-3635-10 28 cm/11"
 13 mm 12-3635-13 28 cm/11"
 19 mm 12-3635-19 28 cm/11"



Hoehn

12-3636-07
 16 cm/6¼"
 7 mm

12-3636-15
 18.5 cm/7¼"
 15 mm

12-3636-20
 19 cm/7½"
 20 mm



Yankauer
 12-3637-18
 18 cm/7"



Langenbeck
 12-3638-20
 20 cm/8"
 8 mm



Langenbeck
 12-3639-20
 20 cm/8"
 10 mm



Langenbeck
 12-3640-23
 23 cm/9"
 11 mm



Mass. Gen. Hosp.
 12-3641-15
 15 cm/6"



Williger
 12-3642-17
 17 cm/6¾"
 5.5 mm



Williger
 12-3643-16
 16 cm/6¼"



Quervain
 12-3644-20
 20 cm/8"

Elevators ● EN
 Elevatorien ● DE
 Elevadores ● ES



12-3645-16
 16 cm/6 1/4"

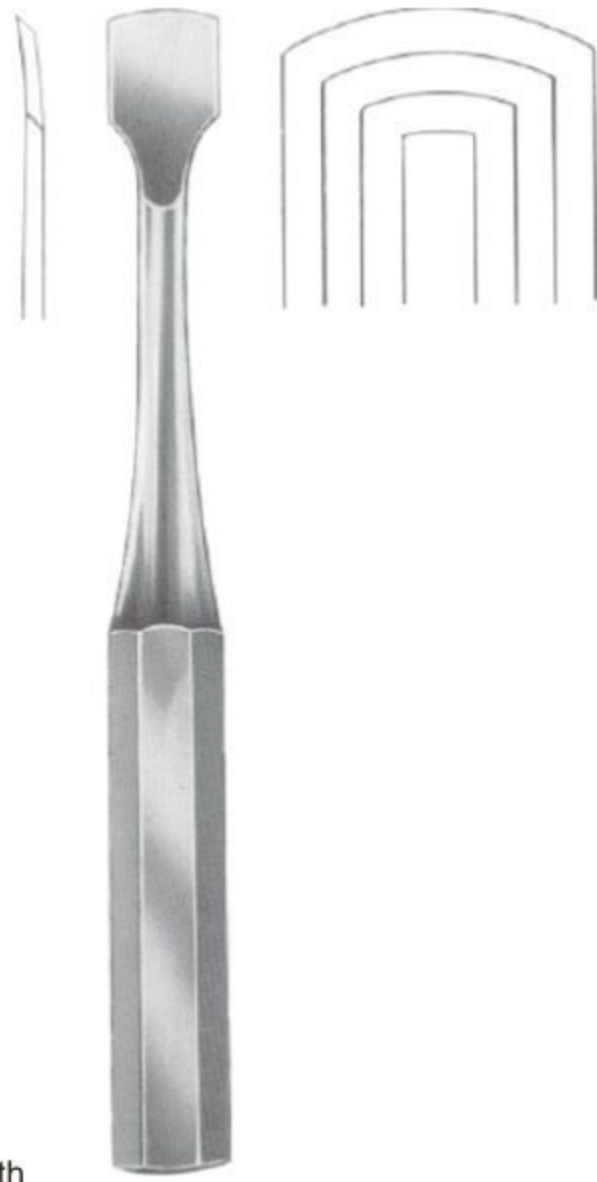

Width
Key
 6 mm 12-3646-06 19 cm/7 1/2"
 12 mm 12-3646-12 19 cm/7 1/2"
 19 mm 12-3646-19 19 cm/7 1/2"
 25 mm 12-3646-25 19 cm/7 1/2"



Konig
 12-3647-15
 15 cm/6"
 4.5 mm



Konig
 12-3648-15
 15 cm/6"
 4.5 mm



Alderdyce
 12-3649-21
 21 cm/8 1/4"



McDonald
 12-3650-19
 19 cm/7 1/2"



Watson-Cheyne
 12-3651-19
 17.5 cm/7"



Sebileau
 12-3652-17
 17 cm/6 3/4"



12-3653-14
 14 cm/5½"
 2.8 mm



12-3654-15
 15 cm/6"
 5 mm



12-3655-15
 15 cm/6"
 7 mm

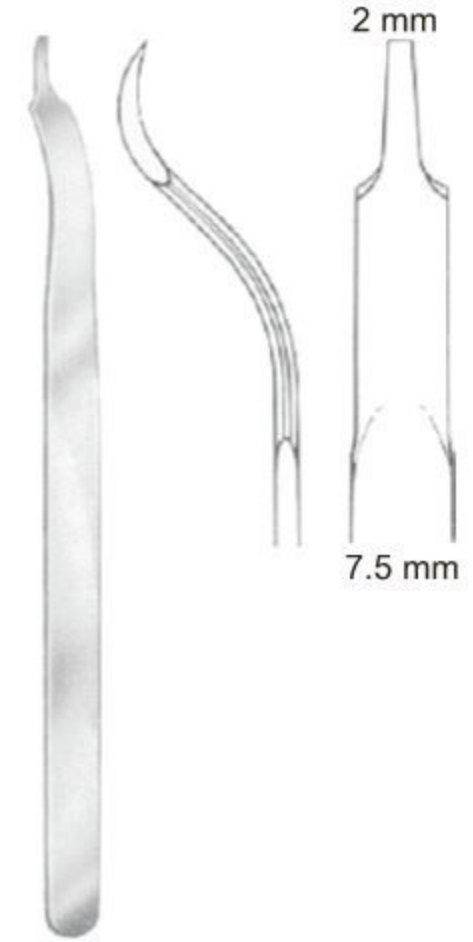

Buck-Gramcko
 12-3656-15
 15 cm/6"

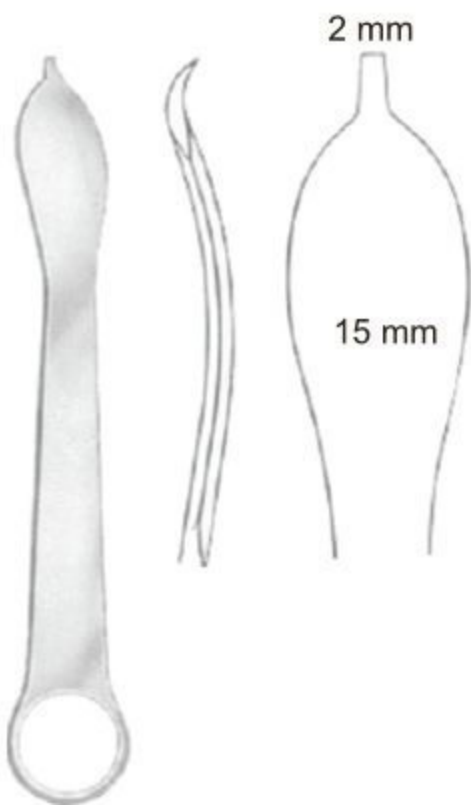

12-3657-12
 12.5 cm/5"



Mini-Hohmann
 12-3658-06
 16 cm/6¼"
 6 mm



12-3658-06
 6 mm



12-3658-08
 8 mm

Bone Levers ●— EN
 Knochenhebel ●— DE
 Elevadores para huesos ●— ES



12-3659-17
17 mm

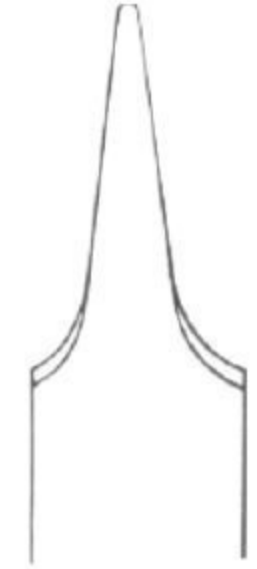

12-3660-17
17 mm



12-3661-26
26.5 cm/10½"
24 mm



Lange-Hohmann
12-3662-26
26 cm/10¼"
22 mm



Hohmann
12-3663-22
22 cm/8¾"
8 mm



Hohmann
12-3664-24
24 cm/9½"
14mm



Hohmann
 12-3665-26
 26 cm/10¼"
 22 mm

Hohmann
 12-3666-28
 28 cm/11"
 33 mm

Hohmann
 12-3667-24
 24 cm/9½"
 43 mm

Hohmann
 12-3668-24
 24.5 cm/9¾"
 43 mm

Hohmann
 12-3669-24
 24 cm/9½"
 70 mm

Hohmann
 12-3670-22
 22 cm/8¾"
 18 mm



Lange-Hohmann modif
 30 mm 12-3671-26 26.5 cm/10½"
 33 mm 12-3671-29 29.0 cm/11½"

Hohmann-Aldinger
 12-3672-27
 27 cm/10½"

Schumacher (Wagner)
 12-3673-34
 34.5 cm/13½"

Schumacher
 12-3674-29
 29 cm/11½"



Smillie
 14 cm/5½"

12-3675-01
 32x19 mm

12-3675-02
 48x19 mm

12-3675-03
 57x19 mm



12-3675-04
 52x13 mm



12-3675-05
 12x13 mm

Spinal retractors



12-3676-01
 75x30 mm

12-3676-02
 100x30 mm

Taylor
 17 cm/6½"



12-3677-21
 21.5 cm/8½"

Meniscus retractors



Blount
 12-3678-17
 17.5 cm/7"

Bone Levers ●— EN
 Knochenhebel ●— DE
 Elevadores para huesos ●— ES



Murphy-Lane
 12-3679-32
 32 cm/12½"



Chandler

Length	Width	
18 cm	13 mm	12-3680-13
20 cm	19 mm	12-3680-19
23 cm	25 mm	12-3680-23
25 cm	30 mm	12-3680-30



Blount
 12-3681-26
 26 cm/10¼"



Blount
 12-3682-26
 26 cm/10¼"



Bennett 12-3683-44 44 mm
 24 cm/9½" 12-3683-64 64 mm



Smillie
 12-3684-17
 17 cm/6¾"



Smillie
 12-3685-17
 17 cm/6¾"



Smillie
 12-3686-17
 17 cm/6¾"



Salenius
 12-3687-22
 22 cm/8¾"



Salenius
 12-3688-22
 22 cm/8¾"



12-3689-17
 17.5 cm/7"



Neff
 12-3690-21
 21.5 cm/8½"



Canad-Modell
 12-3691-01 20 cm/8"



12-3692-02



Bircher
 12-3693-20
 20.5 cm/8"

Drill guide and dura protecting forceps



Adson
 12-3694-15
 15 cm/6"

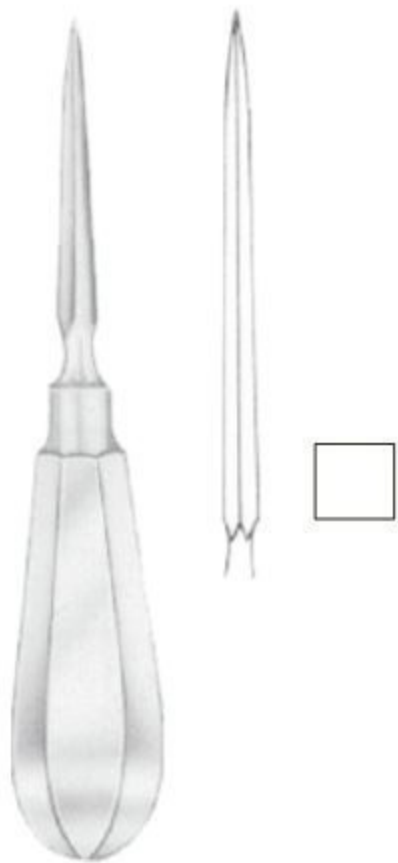

12-3695-14
 14 cm/5½"



Perthes
 12-3696-21
 21 cm/8¼"



12-3697-14
 14 cm/5½"

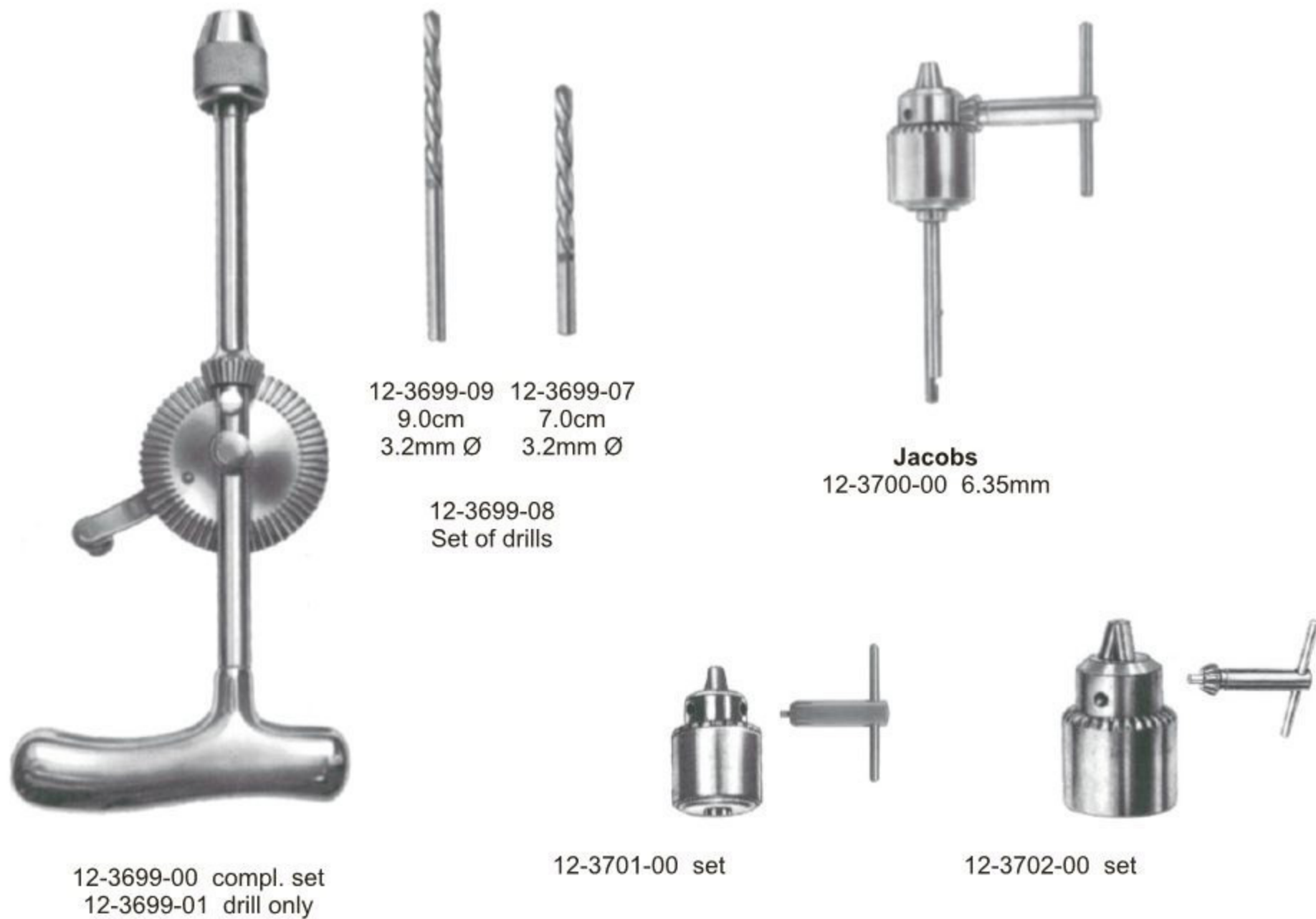
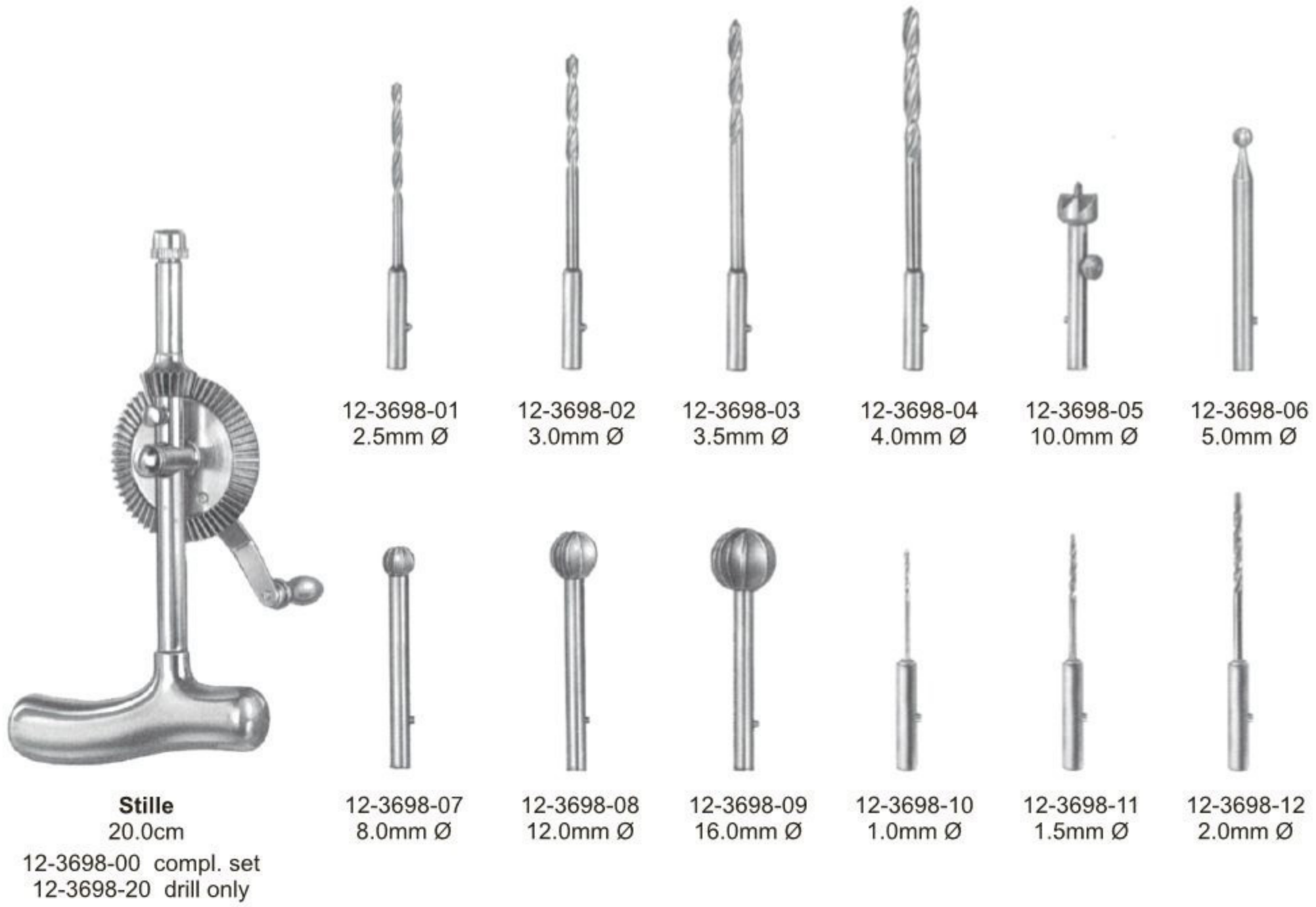

Hand Drills ● EN
 Handbohrapparate ● DE
 Perforadores de mano ● ES



Stille-Sherman
 24.0cm
 12-3703-00 compl. set
 12-3703-24 drill only



12-3703-25 2.5mm Ø
 12-3703-30 3.0mm Ø
 12-3703-35 3.5mm Ø



Hudson
 12-3704-00 compl. set / 6
 (12-3704,01,
 02,03,07,09)
 12-3704-27 handle only



12-3704-01 9mm Ø
 12-3704-02 14mm Ø
 12-3704-03 16mm Ø
 12-3704-04 22mm Ø



Cushing 12-3704-05 14mm Ø
 12-3704-06 2mm Ø
Mckenzie 12-3704-07 13mm Ø
Errico 12-3704-08 16mm Ø
 12-3704-09



12-3705-00



12-3706-00



12-3707-00



12-3708-01

12-3708-00 complete set



12-3709-01

12-3709-02



12-3709-03

Kirschner
 12-3709-00 complete set

Hand Drills ● EN
 Handbohrapparate ● DE
 Perforadores de mano ● ES

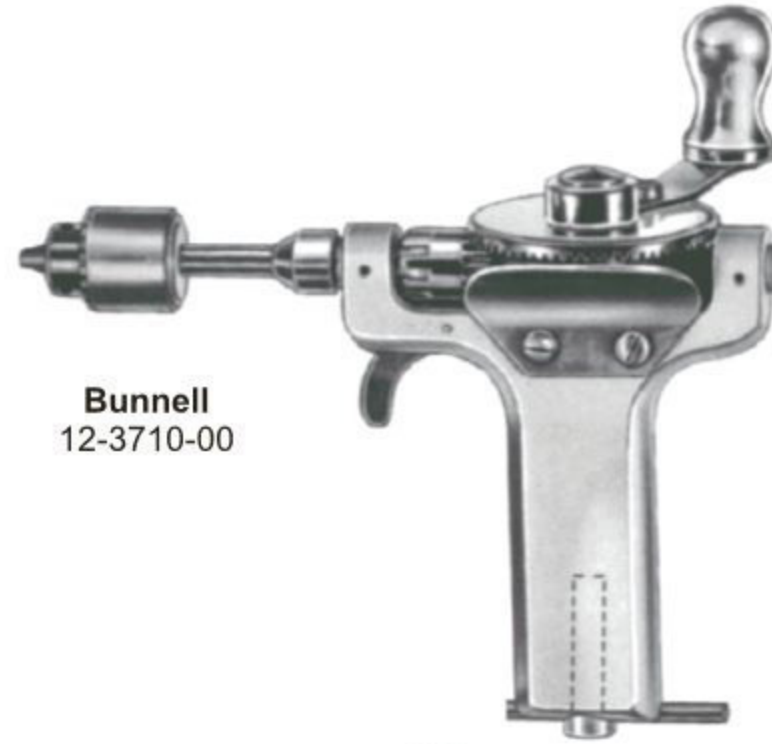

Bunnell
 12-3710-00



Ralk
 12-3711-00

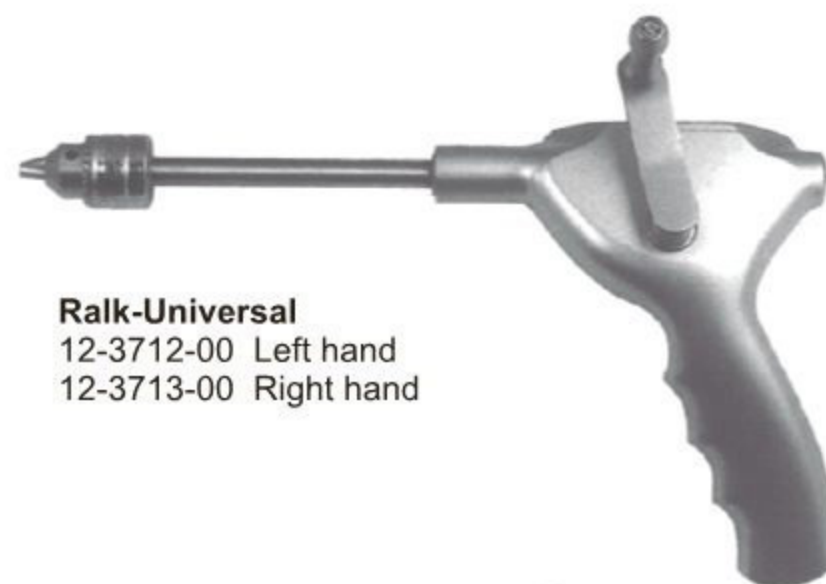

Ralk-Universal
 12-3712-00 Left hand
 12-3713-00 Right hand



12-3714-00



Spare Saw Blade
 12-3715-12 12mm
 12-3715-15 15mm
 12-3715-18 18mm

Charriere
 12-3715-35 35.0cm



Spare Saw Blade
 12-3716-03 3mm
 12-3716-05 5mm
 12-3716-07 7mm

Heferich-Bier
 12-3716-39 39.0cm



Lindemann
 12-3717-20 20.0cm



Langenbeck
 12-3718-23 23.0cm

12-3719-06 6mm
 12-3719-08 8mm
 12-3719-12 12mm
 12-3719-15 15mm
 12-3719-18 18mm

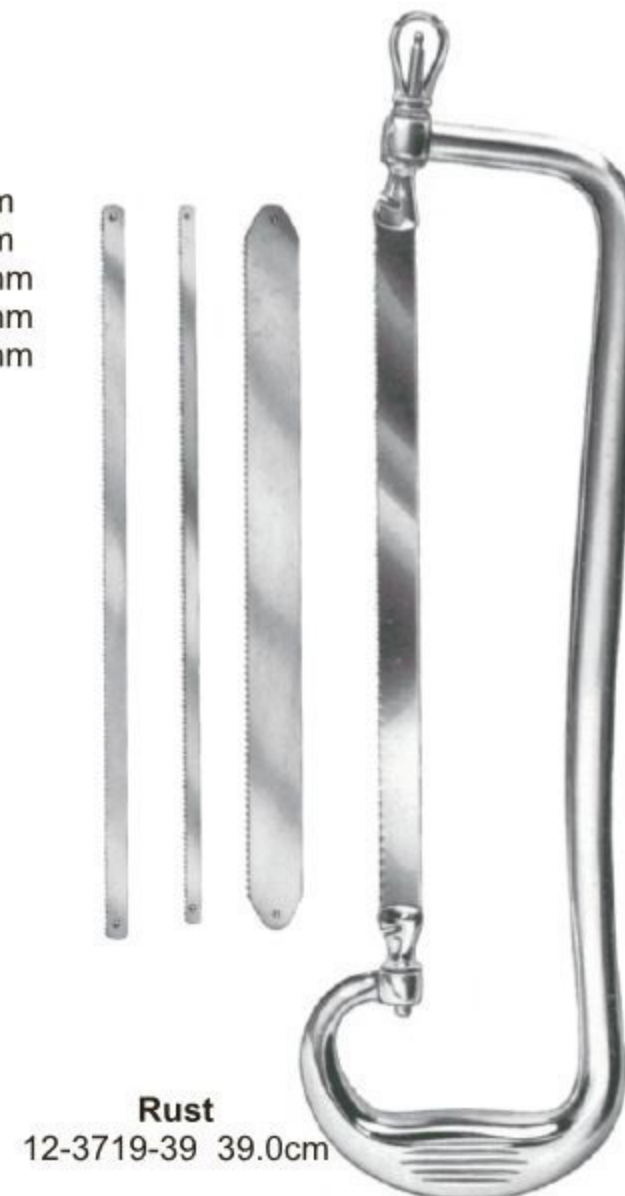

Rust
 12-3719-39 39.0cm



Charriere
 12-3720-27 27.0cm
 12-3720-30 30.0cm
 12-3720-34 34.0cm



Satterlee
 12-3721-31 31.0cm



Charriere
 12-3722-27 27.0cm
 12-3722-30 30.0cm



Satterlee
 12-3723-31
 31.0cm

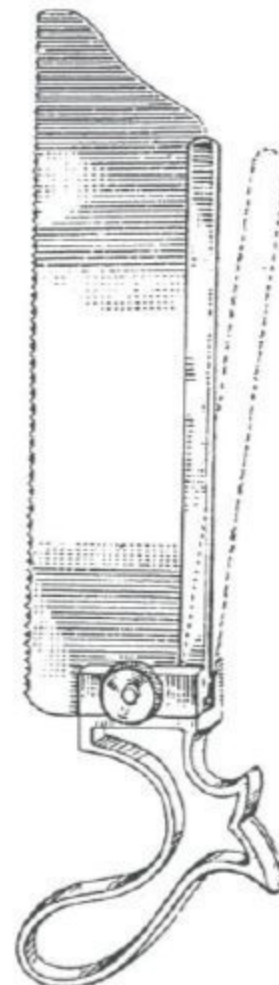

12-3724-23
 23.0cm

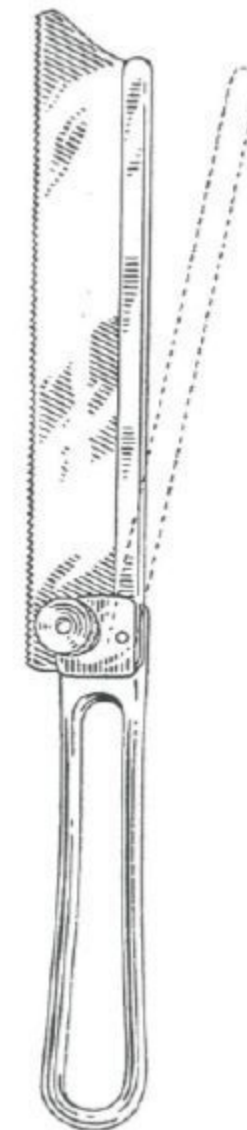

12-3725-19
 19.0cm

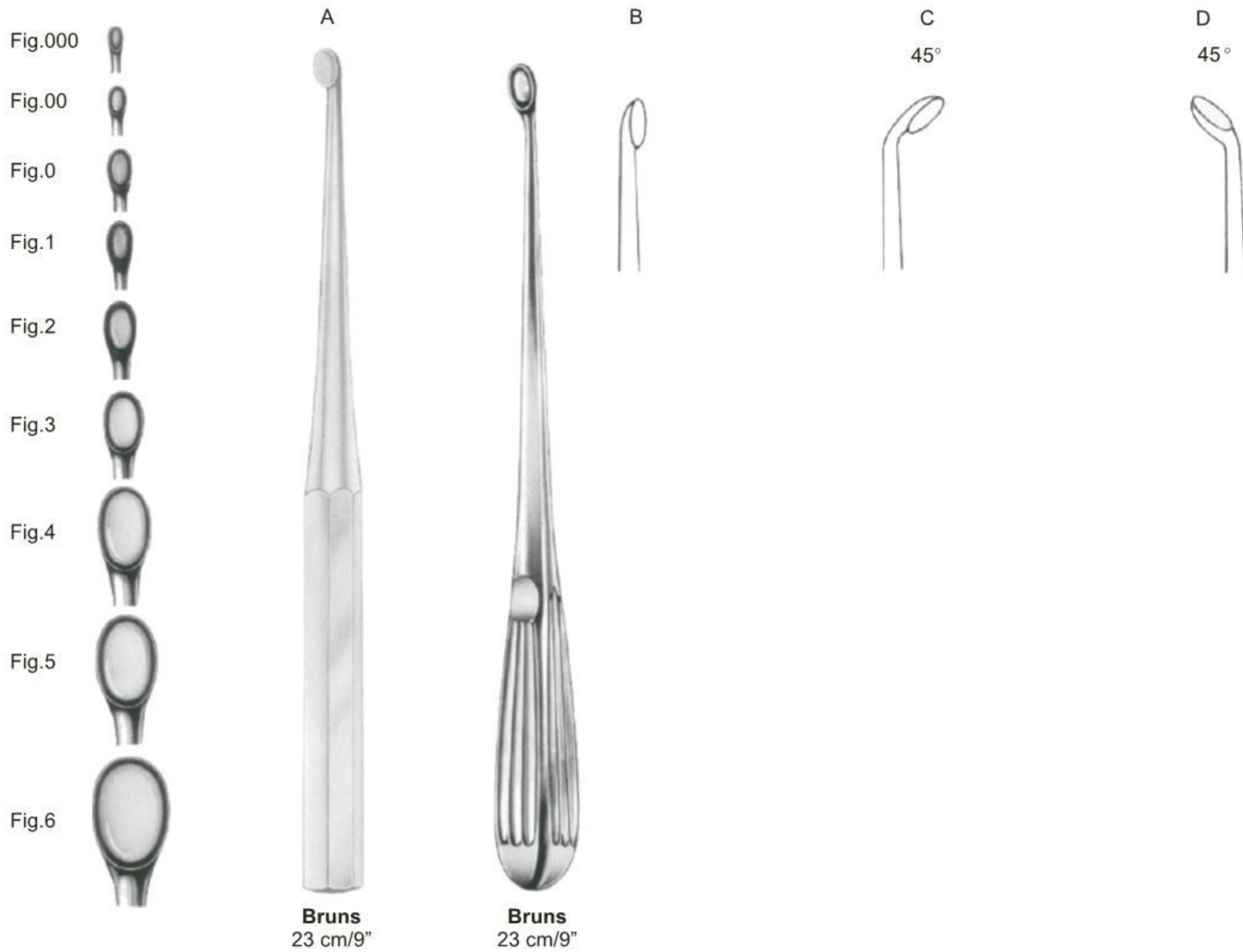

Fig.	A	B	C	D
000	12-3726-30	12-3727-30	12-3728-30	12-3729-30
00	12-3726-20	12-3727-20	12-3728-20	12-3729-20
0	12-3726-10	12-3727-10	12-3728-10	12-3729-10
1	12-3726-01	12-3727-01	12-3728-01	12-3729-01
2	12-3726-02	12-3727-02	12-3728-02	12-3729-02
3	12-3726-03	12-3727-03	12-3728-03	12-3729-03
4	12-3726-04	12-3727-04	12-3728-04	12-3729-04
5	12-3726-05	12-3727-05	12-3728-05	12-3729-05
6	12-3726-06	12-3727-06	12-3728-06	12-3729-06

Bone Curettes ● EN
 Scharfe Löffel ● DE
 Cucharillas cortantes ● ES



Volkmann
 17 cm/6¾"



- Fig.
 0000 12-3730-40
 000 12-3730-30
 00 12-3730-20
 0 12-3730-10
 1 12-3730-01
 2 12-3730-02
 3 12-3730-03
 4 12-3730-04
 5 12-3730-05
 6 12-3730-06



Volkmann
 17 cm/6¾"

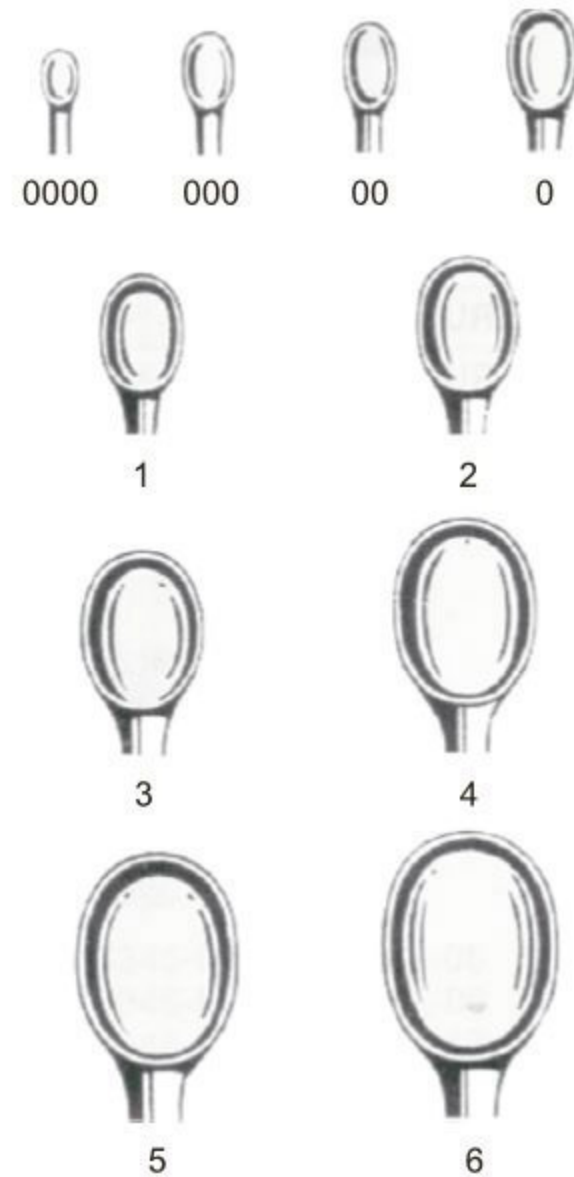

- Fig.
 0000 12-3731-40
 000 12-3731-30
 00 12-3731-20
 0 12-3731-10
 1 12-3731-01
 2 12-3731-02
 3 12-3731-03
 4 12-3731-04
 5 12-3731-05
 6 12-3731-06



12-3732-21
 21 cm/8 1/4"



Epstein



Spinal



Spinal

Fig.	12-3733-30	12-3734-30	12-3735-30
000	12-3733-30	12-3734-30	12-3735-30
00	12-3733-20	12-3734-20	12-3735-20
0	12-3733-10	12-3734-10	12-3735-10
1	12-3733-01	12-3734-01	12-3735-01
2	12-3733-02	12-3734-02	12-3735-02
3	12-3733-03	12-3734-03	12-3735-03
4	12-3733-04	12-3734-04	12-3735-04
5	12-3733-05	12-3734-05	12-3735-05
6	12-3733-06	12-3734-06	12-3735-06
	20 cm/8"	20 cm/8"	20 cm/8"

Bone Curettes ● EN
 Scharfe Löffel ● DE
 Cucharillas cortantes ● ES



	Volkman		Volkman	
Length	Oval/Oval		Oval/Round	
cm	in			
13	5"	12-3736-13		12-3737-13
14	5½"	12-3736-14		
16	6¼"			12-3737-16
17	6¾"	12-3736-17		
20	8"	12-3736-20		12-3737-20

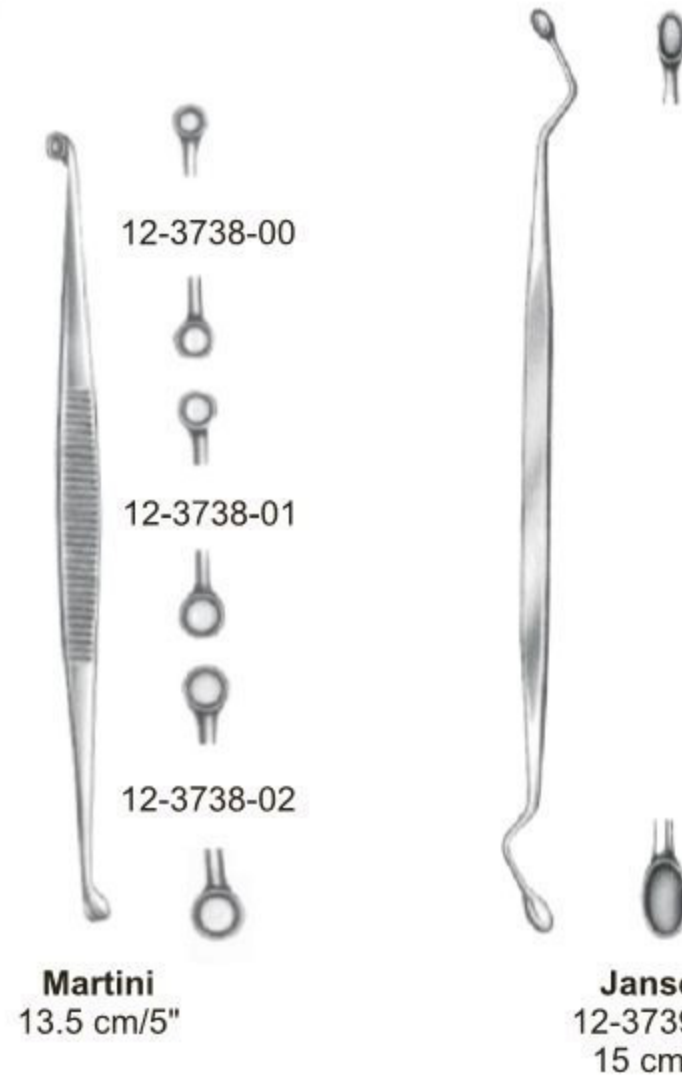

Jansen
 12-3740-16
 16 cm/6¼"



Williger
 13.5 cm/5"



Jacobson
 12-3742-13
 13 cm/5"



Janson
 12-3743-15
 15 cm/6"



Barth
 12-3744-18
 18 cm/7"



Schede
 17 cm/6¾"

Fig.	
000	12-3745-30
00	12-3745-20
0	12-3745-10
1	12-3745-01
2	12-3745-02
3	12-3745-03
4	12-3745-04



Williger
 17.5 cm/7"

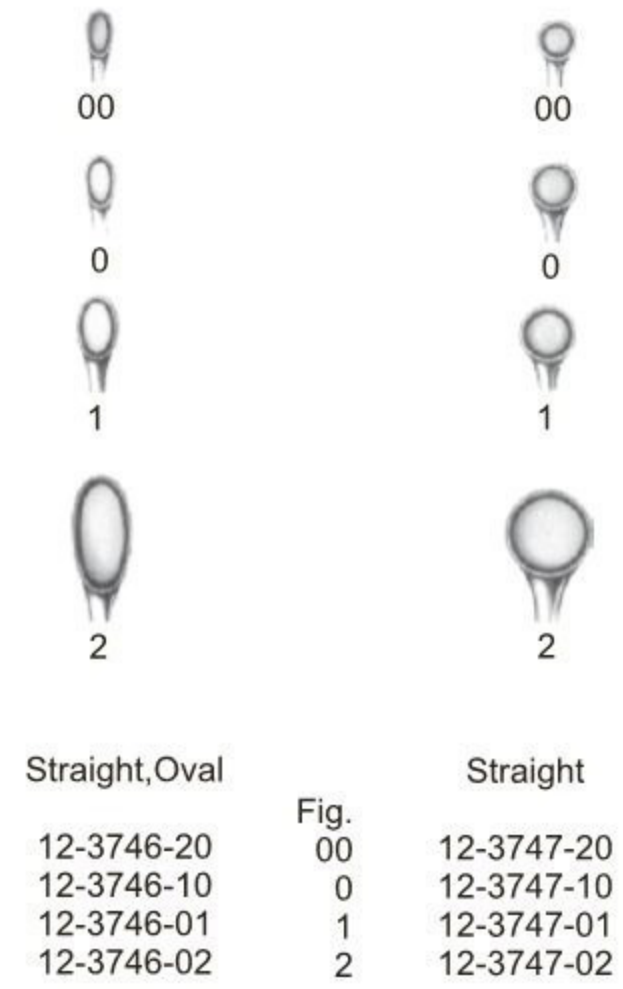

Straight, Oval	Fig.	Straight
12-3746-20	00	12-3747-20
12-3746-10	0	12-3747-10
12-3746-01	1	12-3747-01
12-3746-02	2	12-3747-02



12-3748-01

Uffenorde
 17 cm/6¾"



12-3749-02

Bone Curettes ●— EN
 Scharfe Löffel ●— DE
 Cucharillas cortantes ●— ES



Bruns	Fig.	Spratt
12-3750-30	000	12-3751-30
12-3750-20	00	12-3751-20
12-3750-10	0	12-3751-10
12-3750-01	1	12-3751-01
12-3750-02	2	12-3751-02
12-3750-03	3	12-3751-03
12-3750-04	4	12-3751-04
12-3750-05	5	12-3751-05
12-3750-06	6	12-3751-06

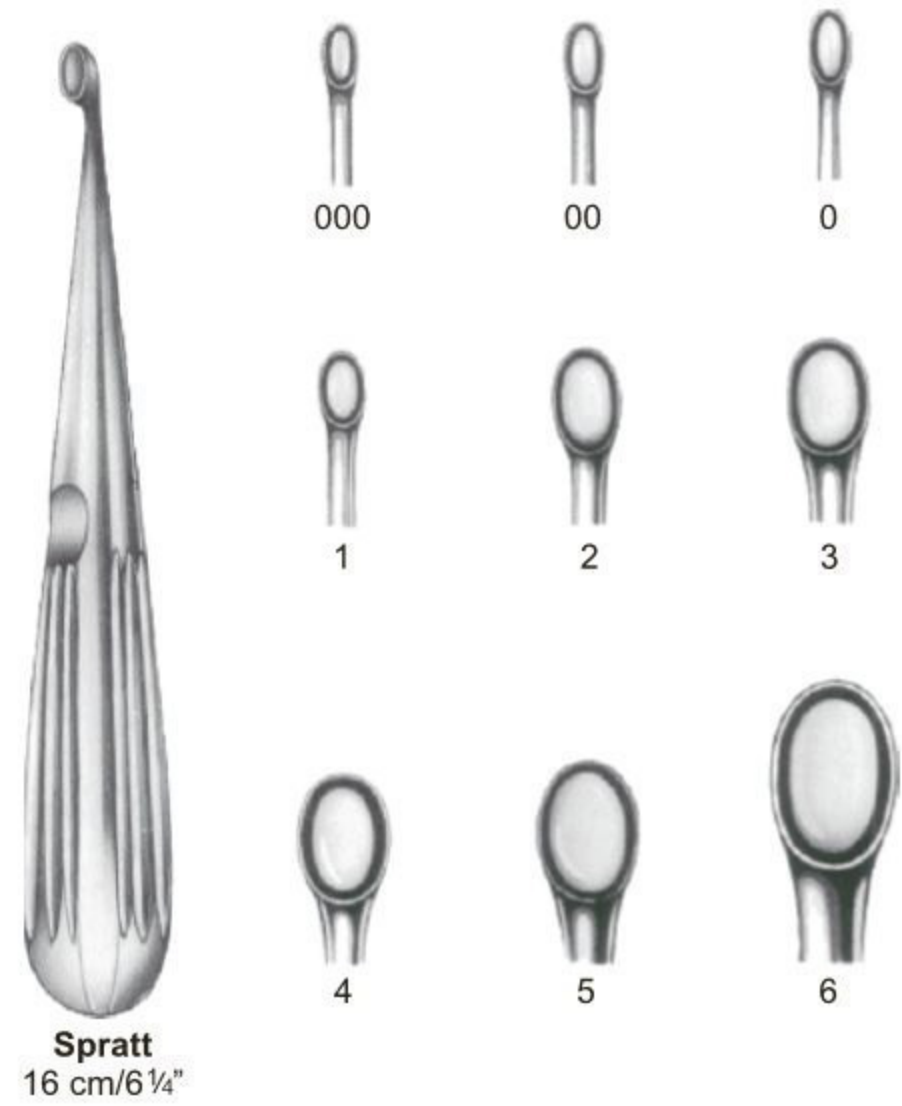

Bruns
 17 cm/6¾"

Spratt
 16 cm/6¼"



mm	Round	Oval
2	12-3752-02	12-3753-02
3	12-3752-03	12-3753-03
4	12-3752-04	12-3753-04
5	12-3752-05	12-3753-05
6	12-3752-06	12-3753-06
7	12-3752-07	12-3753-07
8	12-3752-08	12-3753-08
10	12-3752-10	12-3753-10
12	12-3752-12	12-3753-12
14	12-3752-14	12-3753-14
	17cm/6¾"	22cm/8½"

Swedish pattern

Flexible

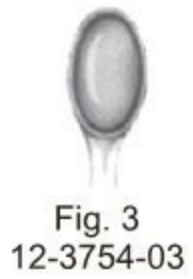

Bone Currettes ● EN
 Scharfe Löffel ● DE
 Cucharillas cortantes ● ES



Volkmann
 27 cm/10½"



Simon
 24 cm/9½"



Simon
 24 cm/9½"



Daubenspeck
 20 cm/8"



Martin
 12-3762-19
 19 cm/7½"



Preston
 12-3763-18
 18 cm/7¼"

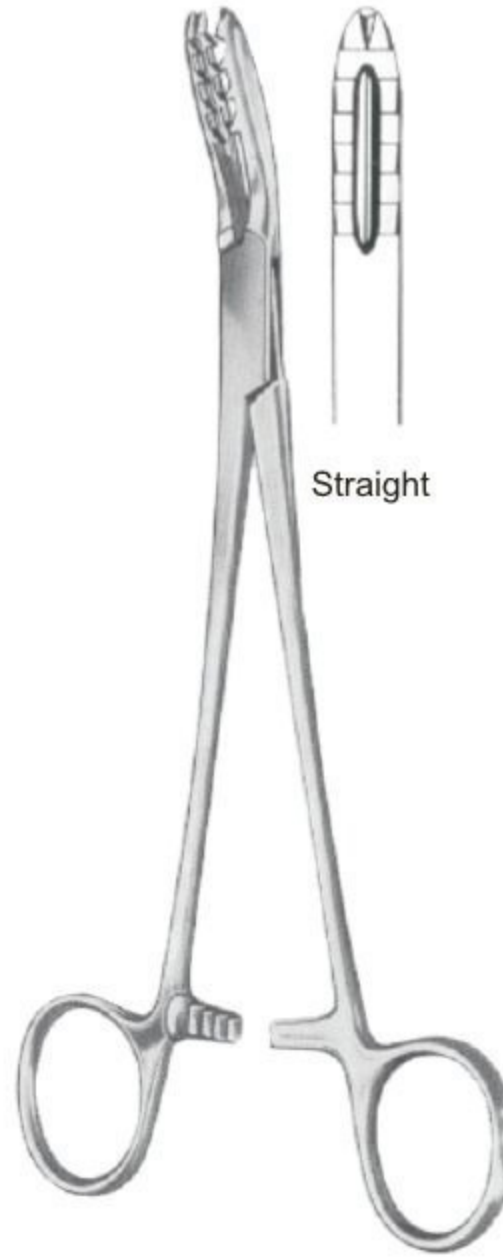

Bircher-Ganske
 12-3764-20
 20 cm/8"



Bircher-Ganske
 12-3765-20
 20 cm/8"



Lewin
 12-3766-17
 17.5 cm/7"



Langenbeck
 12-3767-21
 21 cm/8"



Fergusson
 12-3768-21
 21 cm/8"

Bone Holding Forceps ● EN
 Knochenhaltezangen ● DE
 Pinzas para huesos ● ES

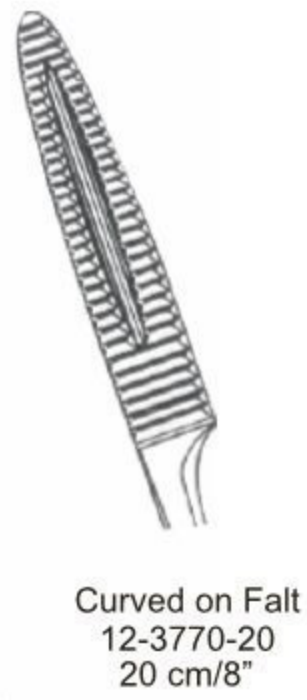

Van Buren
 12-3771-23
 23 cm/9"



Dingmann
 12-3772-19
 19cm/7½"



Dingmann Modif
 12-3773-19
 19 cm/7½"



Neff
 12-3774-21
 21 cm/8¼"



Semb
 12-3775-19
 19 cm/7½"



Semb
 12-3776-19
 19 cm/7½"



Verbrugge
 12-3777-17
 17.5 cm/7"

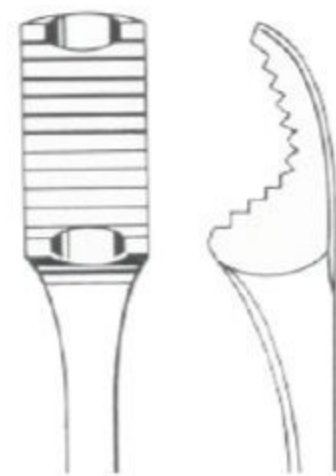

12-3778-25
 25 cm/10"

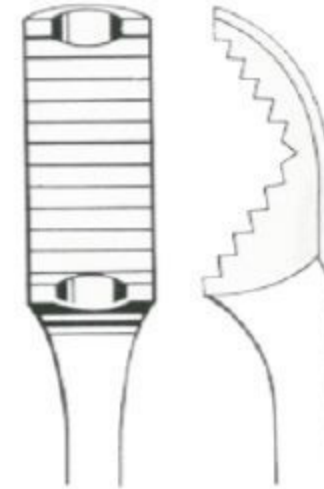

12-3779-26
 26 cm/10¼"
Verbrugge

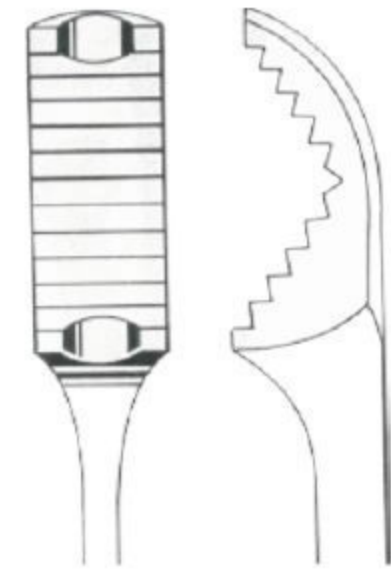

12-3780-27
 27 cm/10½"

Bone Holding Forceps ● EN
 Knochenhaltezangen ● DE
 Pinzas para huesos ● ES



12-3781-16
 16 cm/6¼"
 12-3781-24
 24 cm/9½"



Without Ratchet	Kern		With Ratchet
	cm	in	
12-3782-17	17	6¾"	12-3783-17
12-3782-21	21	8¼"	12-3783-21



12-3784-18	18 cm/07"	12-3785-18
12-3784-23	23 cm/09"	12-3785-23
12-3784-25	25 cm/10"	12-3785-25
12-3784-28	28 cm/11"	12-3785-28



Hey Groves
 12-3786-21 21.0 cm/8¼"
 12-3786-27 27.0 cm/10½"
 12-3786-30 30.5 cm/12"



Farabeuf-Lambotte
 12-3787-26
 26 cm/10¼"



Lambotte
 12-3788-19 19 cm/7½"
 12-3788-23 23 cm/9"
 12-3788-26 26 cm/10¼"



Without Ratchet	Lane	With Ratchet
	cm in	
12-3789-33	33 13"	12-3790-33
12-3789-45	45 17¾"	12-3790-45



12-3791-14
 14.5 cm/5¾"



12-3792-12
 12 cm/4¾"

Bone Holding Forceps ● EN
 Knochenhaltezaugen ● DE
 Pinzas para huesos ● ES



12-3793-15 15 cm/6"
 12-3793-19 19 cm/7 1/2"
 12-3793-24 24 cm/9 1/2"
 12-3793-26 26 cm/10 1/4"
 12-3793-28 28 cm/11"



Handles Detachable

Percy
 12-3794-30

Adjustable



Lambotte
 12-3795-22 22 cm/8 3/4"
 12-3795-27 27 cm/10 1/2"
 12-3795-30 30 cm/12"



Farabeuf
 12-3796-23 23 cm/9"
 12-3796-26 26 cm/10 1/4"



Lambotte
 12-3797-22 22.5 cm/9"
 12-3797-25 25.5 cm/10 1/2"
 12-3797-33 33 cm/13 1/2"



Stellbrink
 17.5 cm/7"



Bane-Hartmann
 12-3800-17
 17.5 cm/7"



Mini-Friedmann
 12-3801-12
 12.5 cm/5"



Friedmann
 12-3802-14
 14 cm/5½"

Bone Holding Forceps, Bone Holding Clamps ● EN

Knochenhaltezaugen, Knochenhalteklammern ● DE

Pinzas para huesos, Pinzas porta-huesos ● ES



12-3803-13
13.5 cm/5¼"



12-3804-20
20 cm/8"



12-3805-17
17 cm/6¾"



Patella Forceps

12-3806-17
17.5 cm/7"



Lowman-Hoglund
12-3807-19
19 cm/7½"



Lowman
12-3808-18 18 cm/7"
12-3808-20 20 cm/8"
12-3808-22 22 cm/8¾"



Lowman
12-3809-12
12 cm/4¾"

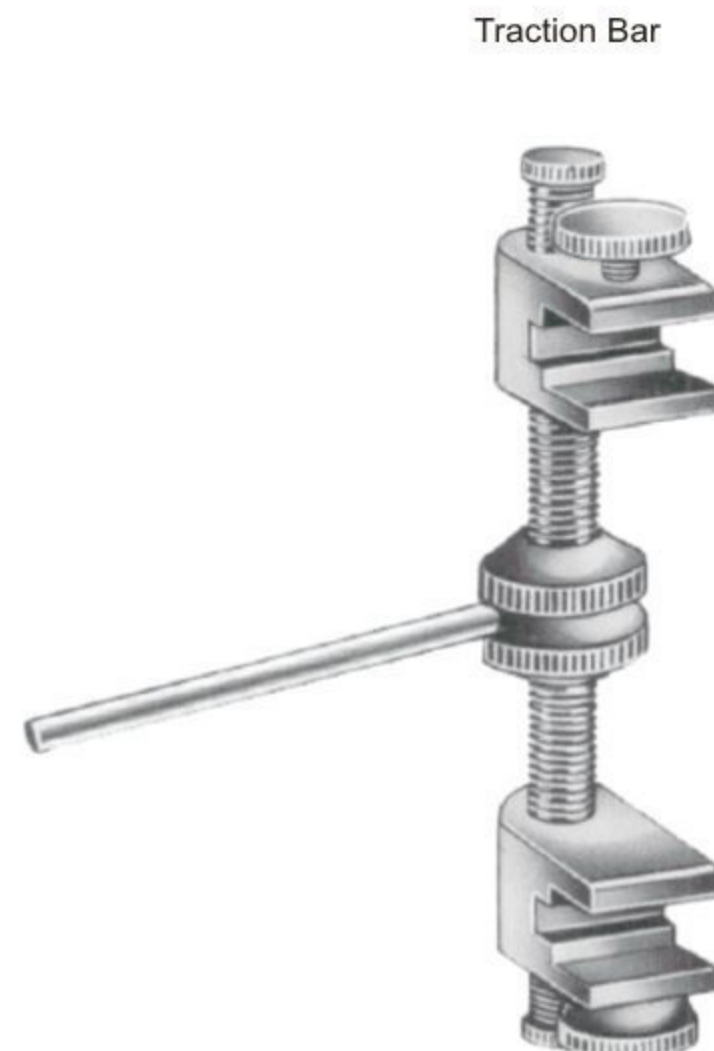

Traction Bar

12-3810-18
12-3810-50



12-3811-16



12-3811-16A

Mead
 16.5 cm/6½"



	Lempert	
Straight	cm in	Curved
12-3812-16	16 6¼"	12-3813-16
12-3812-19	19 7½"	12-3813-19



Beyer
 12-3814-18
 18 cm/7"



12-3815-17



12-3816-17

Jansen
 17.5 cm/7"



12-3817-15



12-3818-15



12-3819-15

Blumenthal
 15.5 cm/6"



Hakansson
 12-3820-15
 15.5 cm/6"

- Bone Rongeur Forceps ● EN
- Hohlmeißelzangen ● DE
- Pinzas-gubias ● ES



Friedmann-Delicate
15 cm/6"



12-3821-15

12-3822-15



Bacon
12-3823-20
20 cm/8"



Cleveland
12-3824-14 14 cm/5½"
12-3824-17 17 cm/6¾"



Hartmann
12-3825-18
18.5 cm/7¼"



Olivecrona
12-3826-20
20 cm/8"



Kleinert-Kutz
 15 cm/6"



12-3827-15
 2 mm



12-3828-15
 3 mm



Bohler
 15 cm/6"



12-3829-15



12-3830-15



**Beyer
 Zaufal-Jansen**
 18 cm/7"



Zaufal-Jansen
 12-3831-18



Beyer
 12-3832-18



Mayfield
 12-3833-17
 17 cm/6¾"



Ruskin
 12-3834-18
 18 cm/7"
 Angled



Straight
 12-3835-18
 18 cm/7"
 12-3835-23
 23 cm/9"



Ruskin

Curved
 12-3836-18
 18 cm/7"
 12-3836-23
 23 cm/9"

Bone Rongeur Forceps ● EN
 Hohlmeißelzangen ● DE
 Pinzas-gubias ● ES



Jansen
 12-3837-18
 18 cm/7"



Luer
 17 cm/6¾"



Straight
 12-3838-17

Curved
 12-3839-17



Luer
 18.5 cm/7¼"

Heavy Pattern

Straight
 12-3840-18

Curved
 12-3841-18



Luer
 15 cm/6"



12-3842-15



12-3843-15



12-3844-15



Adson
 20 cm/8"

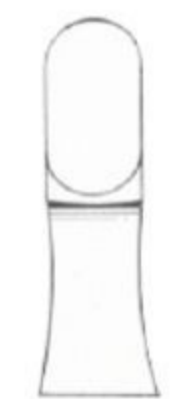

12-3845-20



Stille-Luer
 22 cm/8¾"



Straight
 12-3846-22



Curved
 12-3847-22



Stille-Luer
 27 cm/10½"



12-3848-27



12-3849-27



Semb
 12-3850-23
 23 cm/9"

Bone Rongeur Forceps ● EN
 Hohlmeißelzangen ● DE
 Pinzas-gubias ● ES



12-3853-03
3 mm



12-3853-04
4 mm



12-3853-05
5 mm



12-3853-03A
3 mm



12-3853-04A
4 mm



12-3853-05A
5 mm



Marquardt
 12-3851-20
 20 cm/8"



Rottgen-Ruskin
 12-3852-24
 24 cm/9½"



Smith-Petersen
 24 cm/9½"



Markwalder
 12-3854-20
 20 cm/8"



Liston
 Straight cm
 12-3855-14 14
 12-3855-17 17
 12-3855-19 19
 12-3855-22 22



Liston
 in Curved
 5½ 12-3856-14
 6¾ 12-3856-17
 7½ 12-3856-19
 8¾ 12-3856-22



Littauer-Liston
 12-3857-15
 15 cm/6"



Cleveland
 12-3858-15 15 cm/6"
 12-3858-17 17 cm/6¾"



Bohler
 15 cm/6"



Bohler
 Straight
 12-3859-15



Bohler
 Curved on flat
 12-3860-15



McIndoe
 12-3861-17
 17.5 cm/7"

Bone Rongeur Forceps ● EN
 Hohlmeißelzangen ● DE
 Pinzas-gubias ● ES

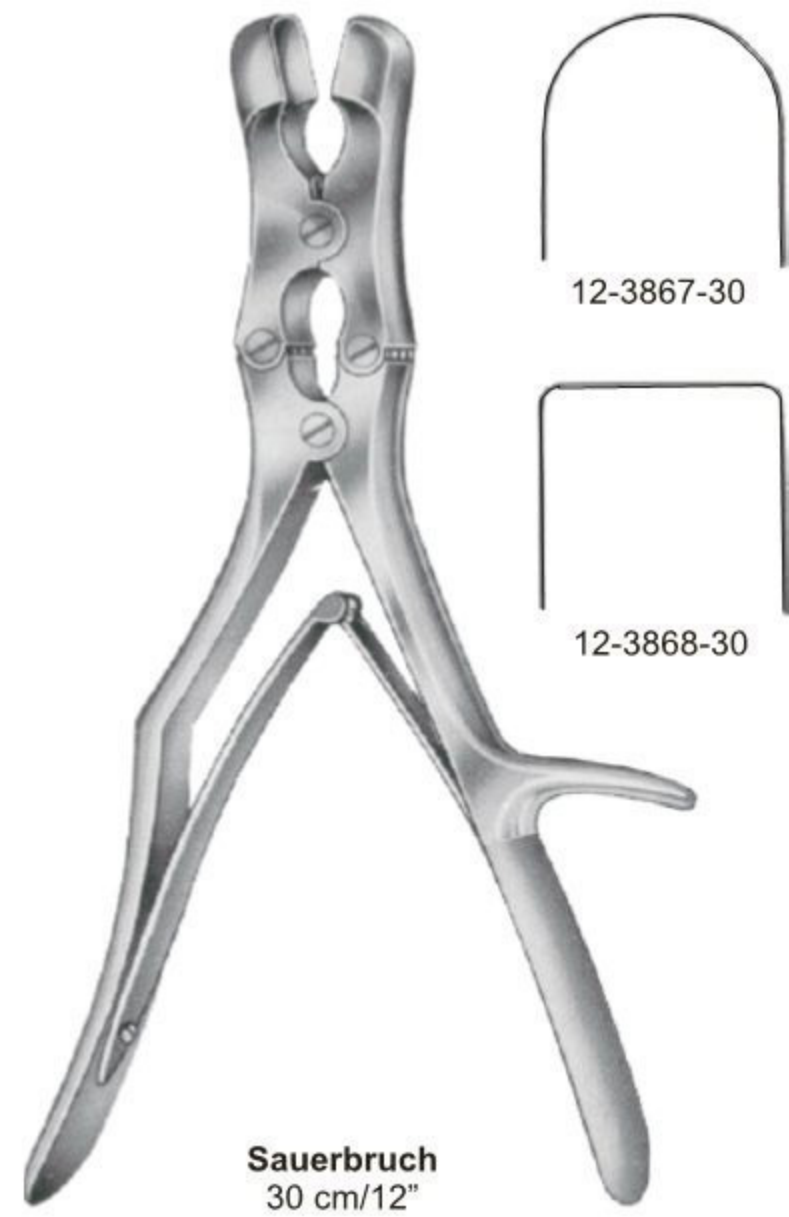
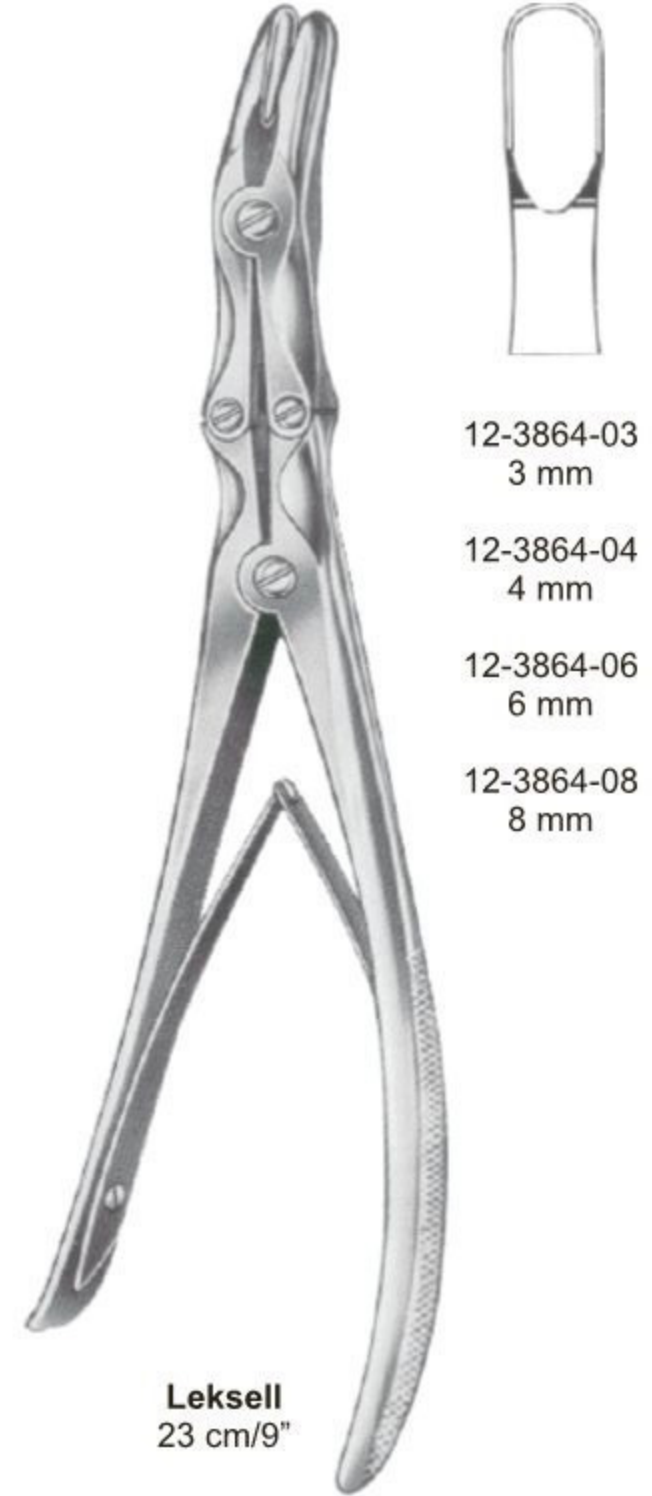

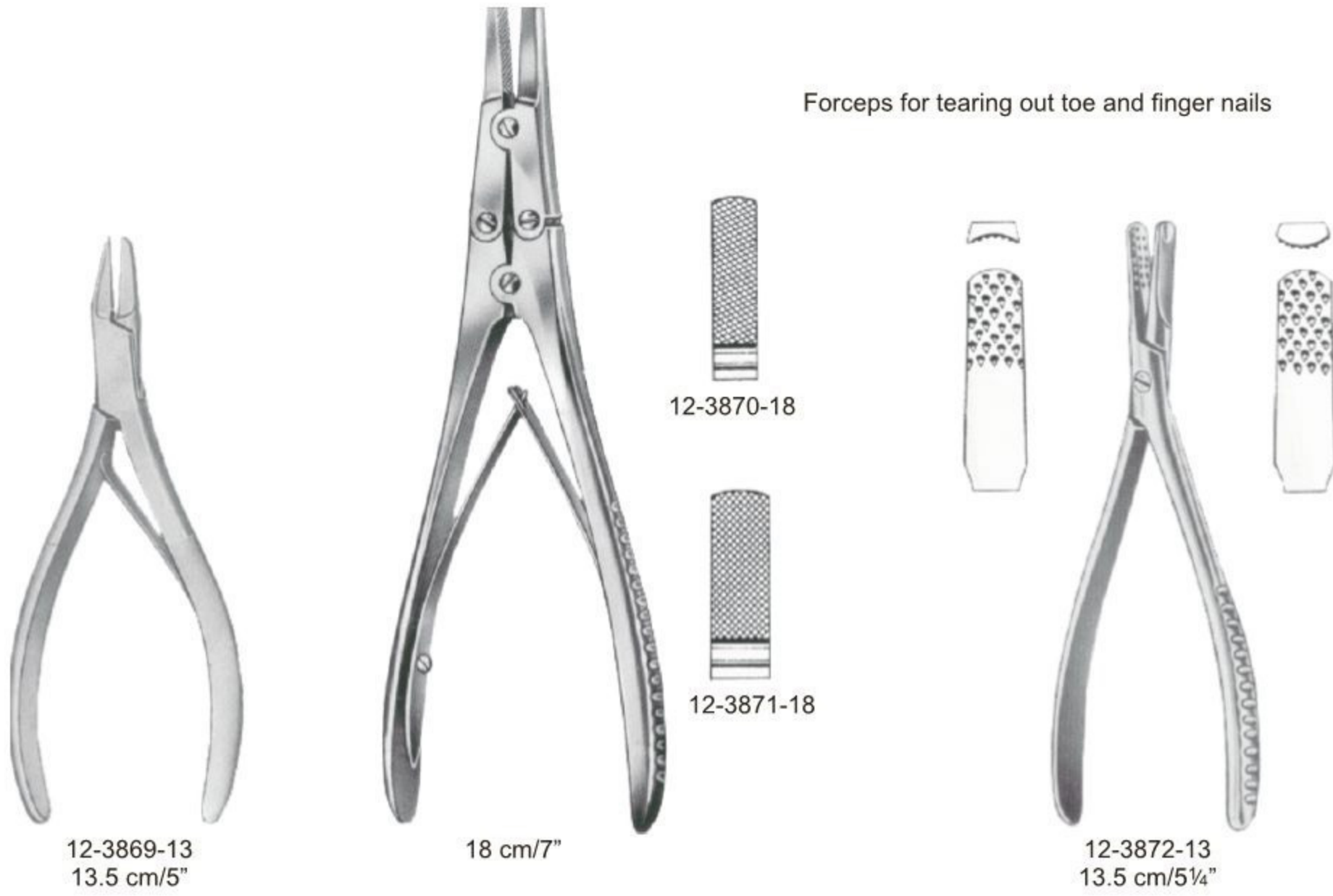

Saw blade



12-3873-17
17 cm/6 3/4"



12-3874-17
17 cm/6 3/4"

Saw blade



Kazanjian
 12-3875-18
 18 cm/7"



Ruskin-Liston
 18.5 cm/7 1/4"



Stille-Liston
 23 cm/9"
 27 cm/10 1/2"

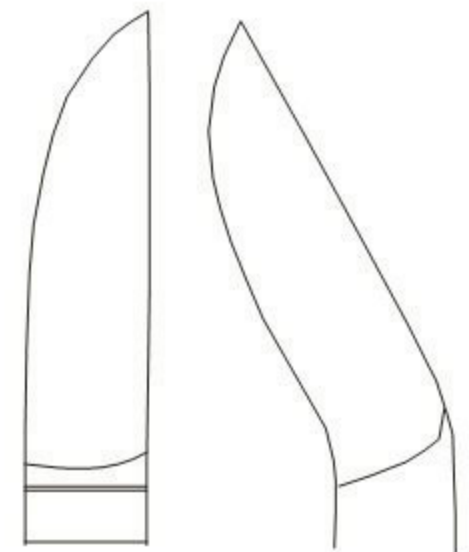
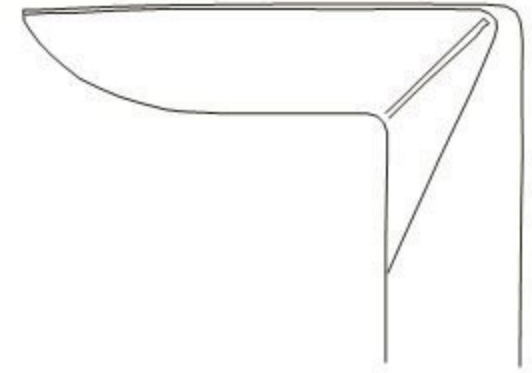

Liston-Key(Horsley)
 12-3881-27
 27 cm/10 1/2"



Semb
 12-3882-24
 24 cm/9 1/2"



12-3883-13 13 cm/5"
 12-3883-18 18 cm/7"



12-3884-17
 17 cm/6¾"

TC



12-3885-15
 15.5 cm/6"



12-3886-17 17 cm/6¾" 12-3887-17



12-3888-19
 19 cm/7½"

Wire Seizing Forceps ● EN
 Faßzangen ● DE
 Pinzas para coger ● ES



12-3889-14
 14 cm/5½"



12-3890-16
 16 cm/6¼"



18cm/7"

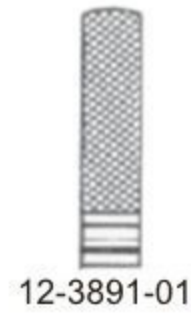

12-3891-01



12-3891-02



12-3891-03



12-3891-04



12-3891-05

TC



12-3892-18 18 cm/7"
 12-3892-20 20 cm/8"



TC



12-3893-16
 15 cm/6"

12-3893-20
 20 cm/8"



12-3894-16
 15 cm/6"



For soft wire
 with a diam. of max.

12-3895-15
 15 cm/6"
 2.0 mm

12-3896-18
 18.5 cm/7¼"
 1.7 mm

12-3897-16
 16 cm/6¼"
 2.0 mm

For hard wire
 with a diam. of max.

1.5 mm

1.7 mm

2.0 mm

Wire Cutting Pliers ● EN
 Draht-Kneifzangen ● DE
 Alicates para cortar alambre ● ES

TC



12-3898-12
 0.7 mm
 0.5 mm
 12 cm/4¾"



12-3899-15
 2.0 mm
 1.0 mm
 15 cm/6"



12-3900-18
 2.0 mm
 1.7 mm
 18 cm/7"



212-3901-18
 2.5 mm
 1.5 mm
 18.5 cm/7¼"



12-3902-18
 2.0 mm
 1.7 mm
 18 cm/7"



12-3903-22
 3.0 mm
 2.5 mm
 22 cm/8¾"



12-3904-22
 3.0 mm
 22 cm/8¾"

Screw Nut Wrench



12-3905-10
 10 cm/4"

Screw Driver



12-3906-12
 12 cm/4 3/4"

Wire Strainer



12-3907-20
 20 cm/8"

Fixation Discs For Drill Wires



12-3908-30
 Pair



12-3909-40



12-3910-42

Fixation Discs



12-3911-51
 Pair

Extension Bows ●— EN
 Extensionsbügel ●— DE
 Estribos para extensión ●— ES



With 1 Pin

Bohler

cm	in	
h x b	h x b	For Arm
16 x 9	6¼ x 3½	12-3912-16

cm	in	
h x b	h x b	For Thigh and Knee
21 x 11	8¼ x 4½	12-3913-21



With 3 Traction Hooks

Kirschner

Clear Width	cm	in
12-3914-01	9.5x7	3¾x2¾
12-3914-02	10.5x10.5	4¼x4¼
12-3914-03	12x12	4¾x4¾
12-3914-04	15.5x15.5	6x6
12-3914-05	20x15.5	8x6



Clear Width

	cm	in
12-3915-18	18x10	07x04
12-3915-27	27x16	10½x06¼



With 3 Traction Hooks

Kirschner

- 12-3916-01 Small Pattern
- 12-3916-02 Medium Pattern
- 12-3916-03 Large Pattern



12-3917-34
 34cm/13½"



Spare Screw

Tendon Passing Instruments

Malleable



Bunnell
 12-3918-18 18cm/7"
 12-3918-23 23cm/9"

Tendon Strippers



Bunnell
 23cm/9"

mm Ø
 4.0 12-3919-40
 4.5 12-3919-45
 5.5 12-3919-55
 Flexible Shaft



Fischer
 12-3920-31
 31 cm/12¼"



Brand



12-3921-50
 50 cm/19½"
 06 mm Ø



12-3922-30
 30 cm/12"
 03 mm Ø



Brand
 12-3923-50
 50 cm/19½"

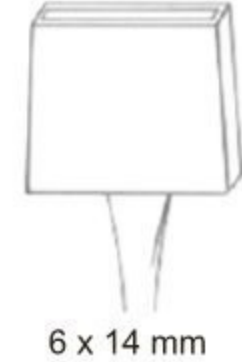

6 x 14 mm

Bone Wire Guides



Bone Wire Tighteners

Loute
 12-3924-00
 21 cm/8¼"



Demel

Bone Wire Guides
 Fig. 1 12-3925-01
 Fig. 2 12-3925-02
 Fig. 3 12-3925-03

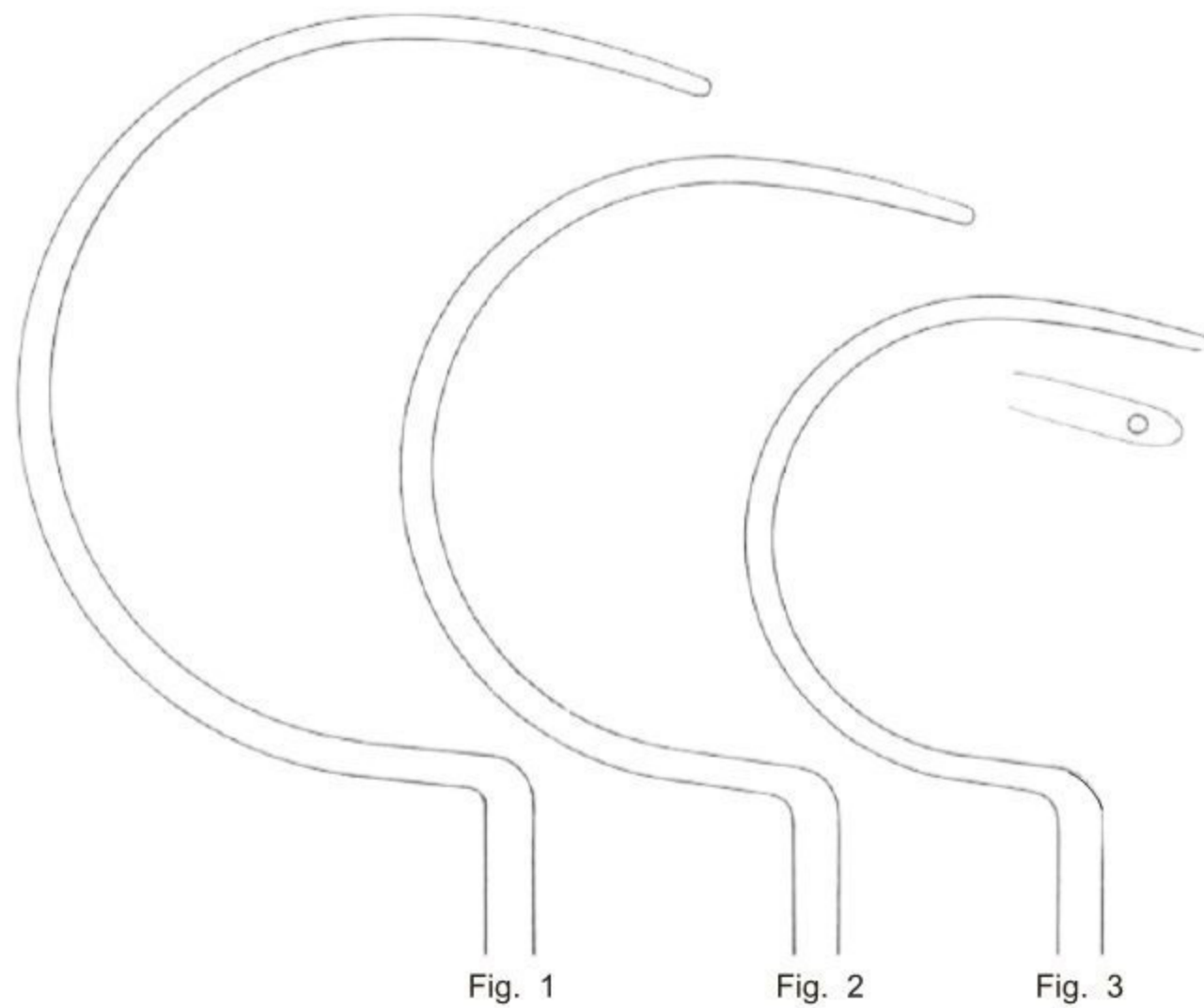

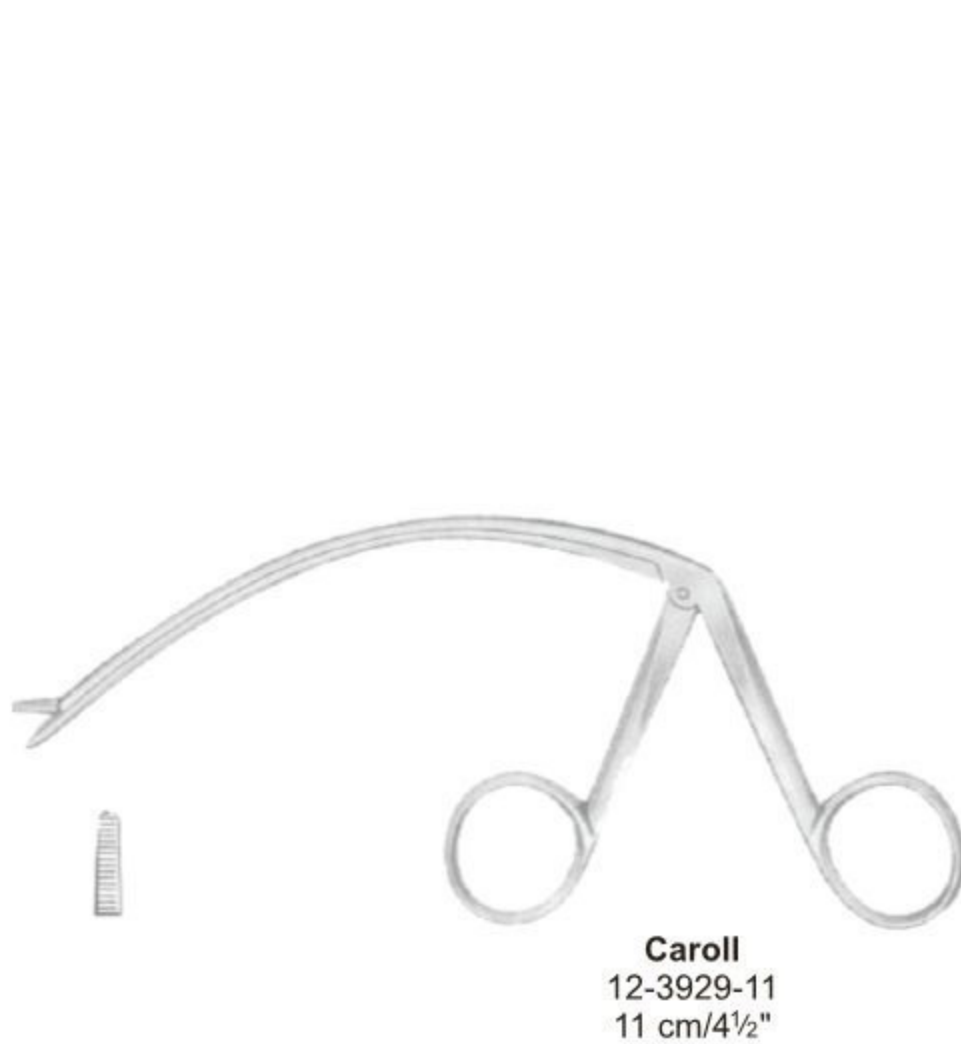
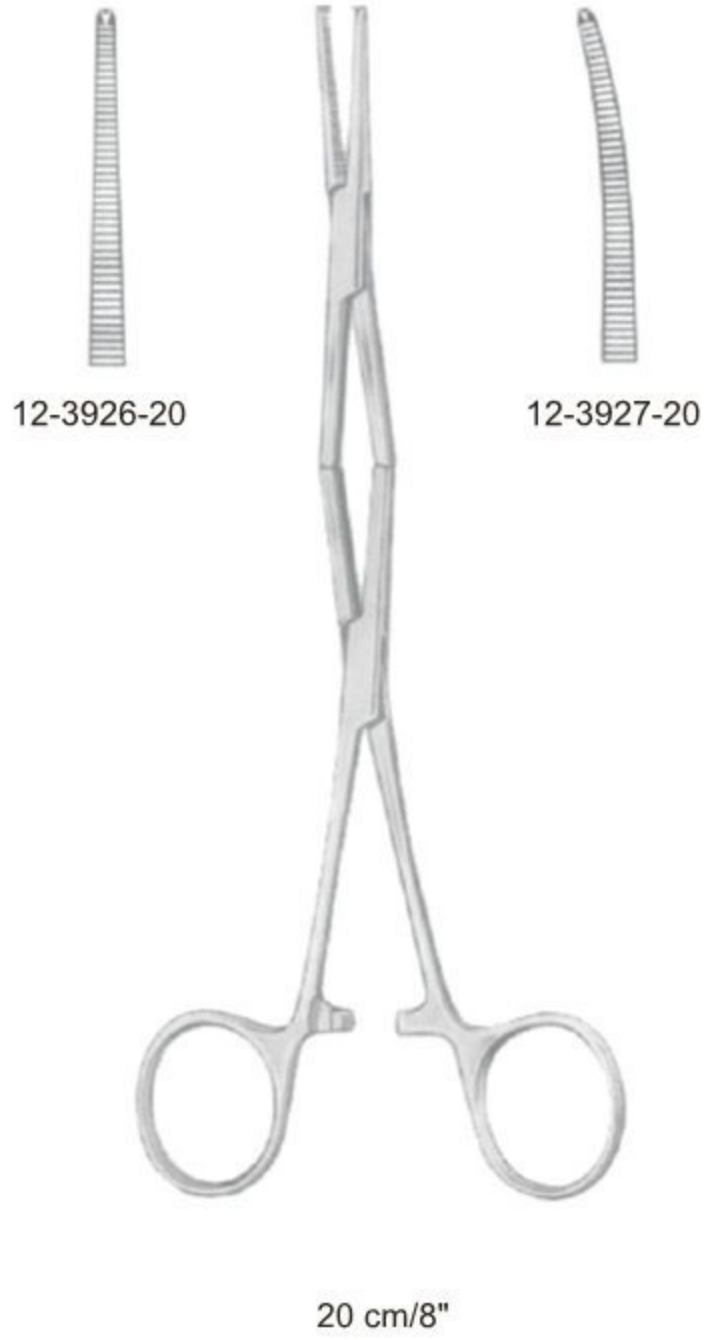

Tendon Seizing Instruments ● EN
 Sehnenfaßinstrumente ● DE
 Instrumentos para coger tendones ● ES



Steinmann
 12-3932-16
 16 cm/6¼"



Larsen
 10 cm/4"

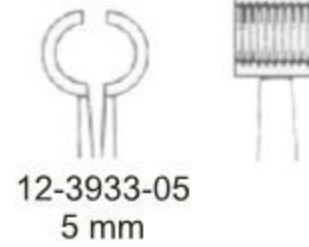

Kleinert-Kutz
 12-3934-20
 20 cm/8"



Brand
 12-3935-15 15 cm/6"
 12-3935-19 19 cm/7½"
 12-3935-24 24 cm/9½"



Brand
 12-3936-15 15 cm/6"
 12-3936-19 19 cm/7½"
 12-3936-24 24 cm/9½"

- EN** Plaster Instruments
- DE** Plaster Instrumente
- ES** Instrumentos de yeso

Page 315 to 317





13-4001-20 20.0cm



Seutin
 13-4002-23 23.0cm



Brun's
 13-4003-24 24.0cm



Brun's (serrated)
 13-4004-24 24.0cm



Stille-Mini
 13-4005-20 20.0cm



Stille
 13-4006-20 20.0cm
 13-4006-23 23.0cm
 13-4006-26 26.0cm
 13-4006-30 30.0cm
 13-4006-37 37.0cm



Stille
 13-4007-24 24.0cm



Haglund-Stille
 13-4008-28 28.0cm



USA Mod Spreader
 13-4009-23 23.0cm



Wolff-Boehler
 13-4010-18 18.0cm
 13-4010-20 20.0cm
 13-4010-22 22.0cm
 13-4010-24 24.0cm
 13-4010-26 26.0cm



Hennig
 13-4011-28
 28.0cm



Beeson
 13-4012-30
 30.0cm



Bergmann
 13-4013-18 18.0cm



Engel
 13-4014-14 14.0cm



Hopkins
 13-4015-20 20.0cm



Esmarch
 13-4016-18 18.0cm



Reiner
 13-4017-18 18.0cm



13-4018-21 21.0cm



Wigmore
 13-4019-19 19.0cm

- EN** Cardiovascular Surgery
- DE** Herz- und Gefäßchirurgie
- ES** Cirugía cardiovascular

Page 318 to 357



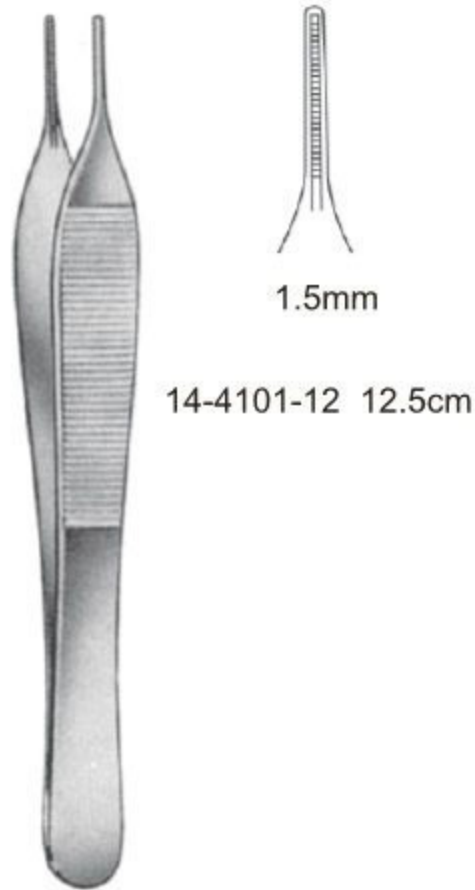

1.5mm
 14-4101-12 12.5cm

DEBAKEY-ADSON



1.0mm
 14-4102-15 15.0cm
 14-4102-18 18.0cm

DEBAKEY-GERALD



1.0mm



1.2mm

14-4103-15 15.0cm
 14-4103-18 18.0cm
 14-4103-24 24.0cm



1.0mm

14-4104-18 18.0cm

DEBAKEY-CUSHING



1.0mm

14-4105-15 15.0cm 14-4106-15
 14-4105-19 19.0cm 14-4106-19
 14-4105-24 24.0cm 14-4106-24

DEBAKEY-DIETRICH

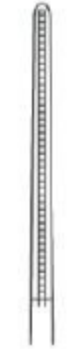

1.5mm



1.0mm

14-4107-15 15.0cm
 14-4107-19 19.0cm
 14-4107-24 24.0cm

DEBAKEY-LIGHT

Atrauma Tissue Forceps ● EN
 Atrauma Pinzetten ● DE
 Pinzas de disección Atrauma ● ES

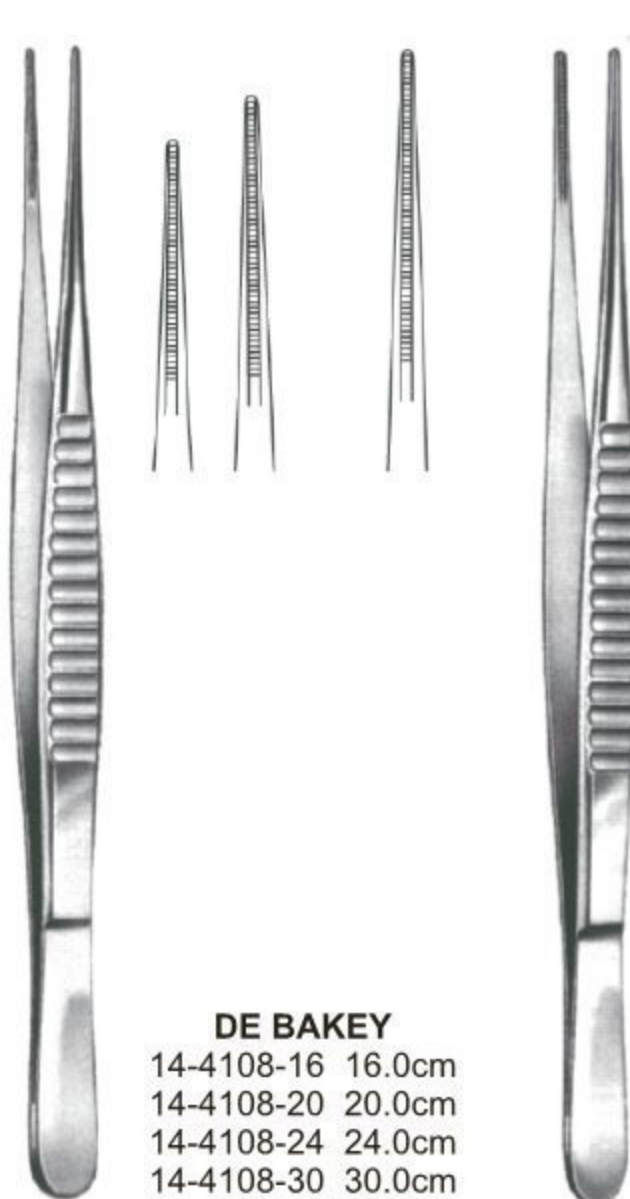

DE BAKEY
 14-4108-16 16.0cm
 14-4108-20 20.0cm
 14-4108-24 24.0cm
 14-4108-30 30.0cm



DE BAKEY
 14-4109-16 16.0cm
 14-4109-20 20.0cm
 14-4109-24 24.0cm
 14-4109-30 30.0cm



DE BAKEY
 14-4110-16 16.0cm
 14-4110-20 20.0cm
 14-4110-24 24.0cm
 14-4110-30 30.0cm

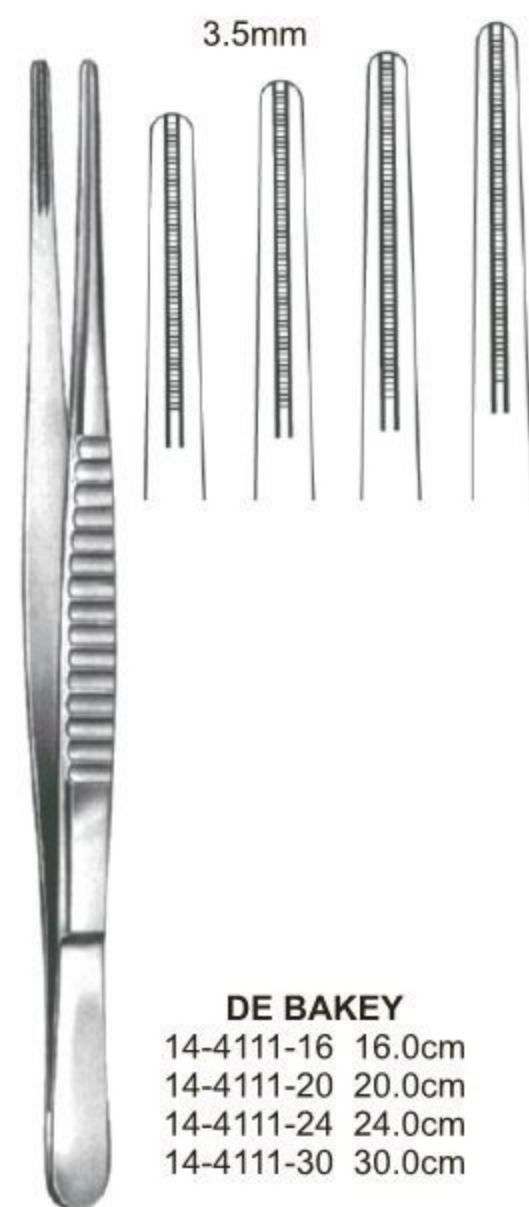

DE BAKEY
 14-4111-16 16.0cm
 14-4111-20 20.0cm
 14-4111-24 24.0cm
 14-4111-30 30.0cm

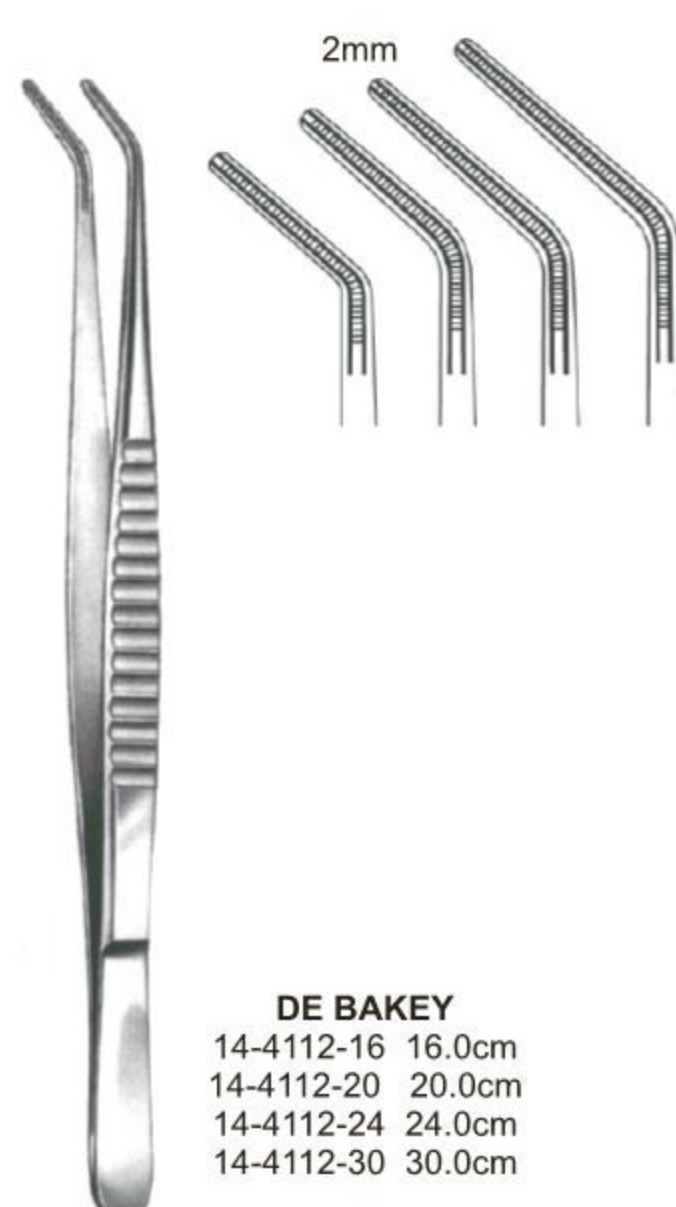

DE BAKEY
 14-4112-16 16.0cm
 14-4112-20 20.0cm
 14-4112-24 24.0cm
 14-4112-30 30.0cm



DE BAKEY
 14-4114-16 16.0cm
 14-4114-20 20.0cm
 14-4114-24 24.0cm
 14-4114-30 30.0cm

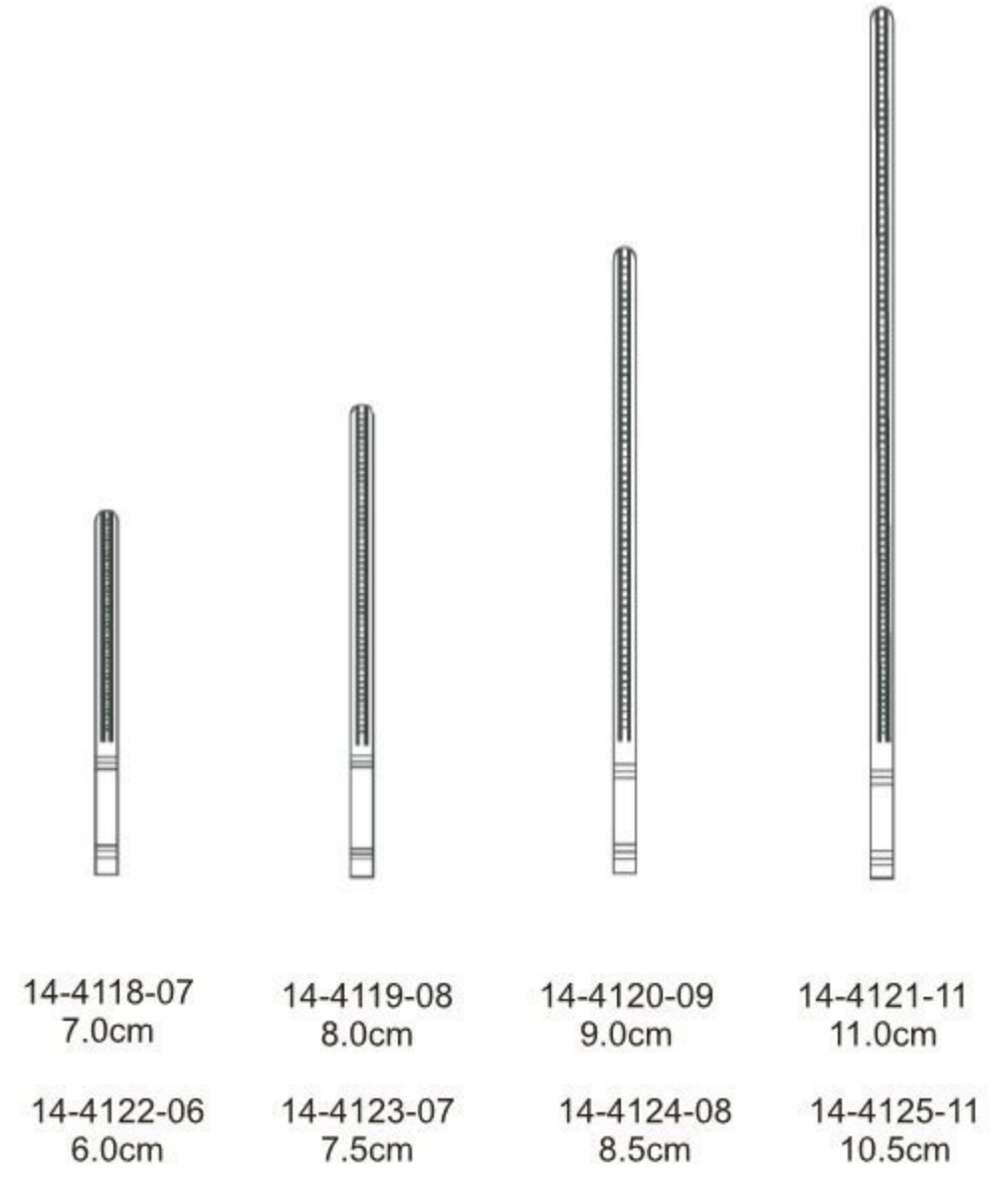
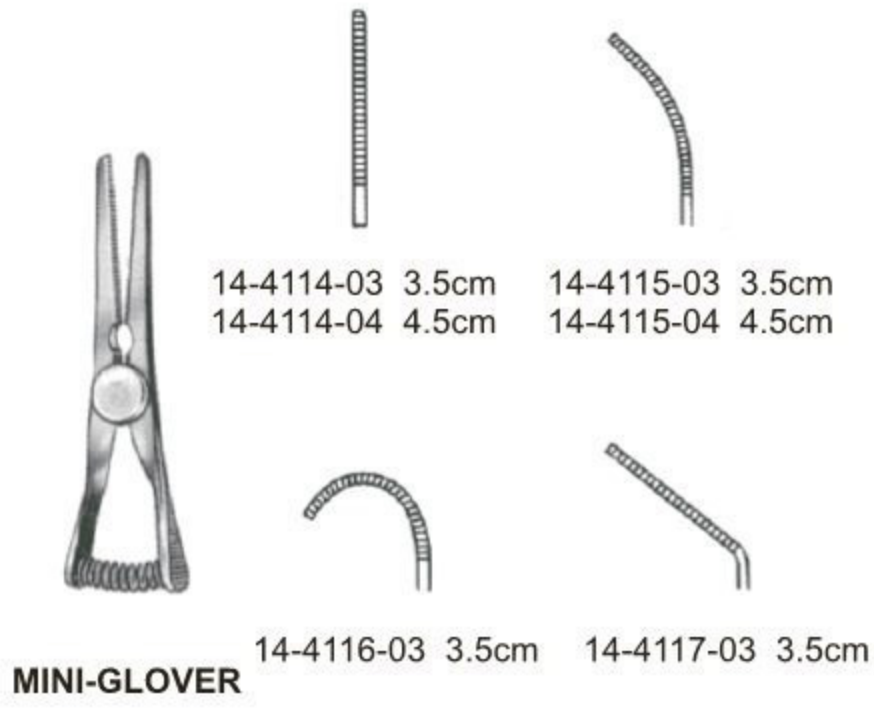

14-4126-05 5.0cm

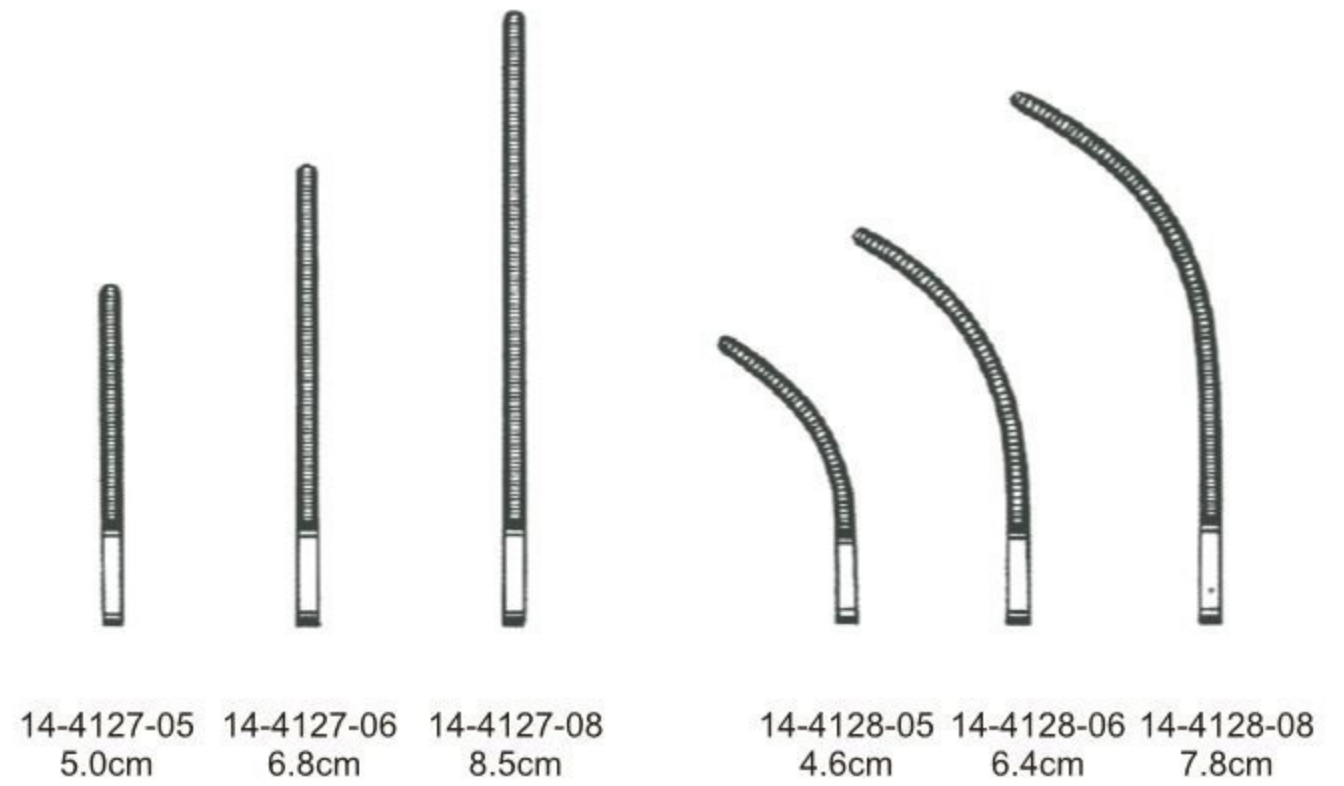

- Atrauma Bulldog Clamps ●— EN
- Atrauma Bulldogklemmen ●— DE
- Atrauma Clamps Bulldog ●— ES



DE BAKEY



14-4129-07
7.5cm



14-4129-08
8.5cm



14-4129-10
10.5cm



14-4129-12
12.0cm



DE BAKEY



14-4130-07
7.0cm



14-4130-08
8.0cm



14-4130-10
10.0cm



14-4130-11
11.5cm



14-4131-23 23.0cm

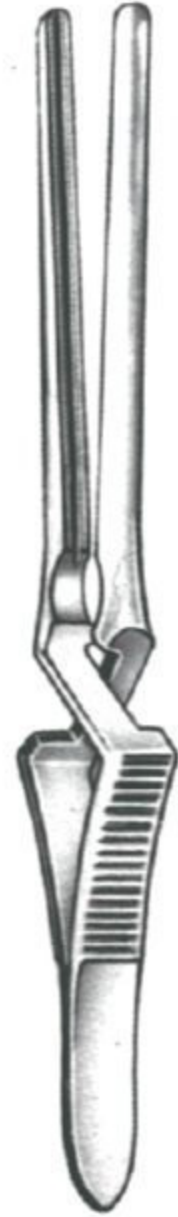

GREGORY SOFT

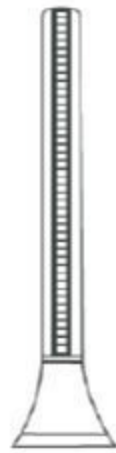

14-4132-09
9.0cm

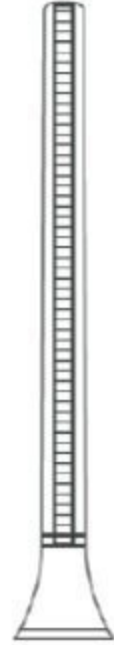

14-4132-11
11.0cm



GREGORY SOFT

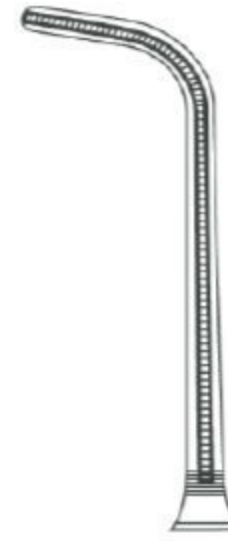

14-4133-09
9.0cm

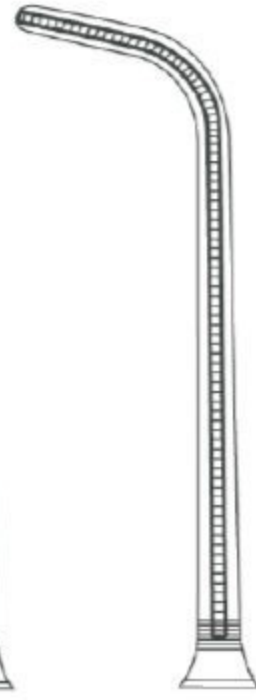

14-4133-11
11.0cm



GREGORY SOFT
11.0cm



14-4134-01



14-4134-02



SANTULLI
14-4135-07 7.0cm

Atrauma Bulldog Clamps ● EN
 Atrauma Bulldogklemmen ● DE
 Atrauma Clamps Bulldog ● ES



DE BAKEY-SATINSKY
 14-4136-07 7.0cm



DE BAKEY-SATINSKY
 14-4137-10 10.0cm



DE BAKEY-CAROTIS
 14-4138-09 9.0cm



De Bakey

Coarctation Clamps



Potts
(De Bakey)



14-4139-21
21 cm/8¼"



14-4139-22
22 cm/8¾"



Potts
(De Bakey)



14-4140-21
21 cm/8¼"



14-4140-22
22 cm/8¾"



De Bakey

Anastomosis Clamps



Potts



14-4141-21
21 cm/8¼"



14-4141-22
22 cm/8¾"



Glover
(Potts)



14-4142-21
21 cm/8¼"

14-4142-22
22 cm/8¼"

Dissecting and
 Ligature Forceps



De Bakey



14-4143-20
 20 cm/8"



14-4143-24
 24 cm/9½"



De Bakey



14-4144-20
 20 cm/8"

14-4144-18
 18 cm/7½"



De Bakey



Leland-Jones



14-4145-01
 19.5 cm/7½"



14-4145-02
 19.5 cm/7½"



14-4145-03
 19.5 cm/7½"



Leland-Jones
 14-4146-18
 18 cm/7"

- EN —● Atrauma Cardiovascular Forceps
- DE —● Atrauma cardiovascular-klemmen
- ES —● Atrauma pinzas-clamps cardiovasculares

Aortic Aneurysm Clamps



De Bakey



De Bakey



14-4147-24
24 cm/9½"



14-4147-27
27 cm/10½"



14-4147-31
31 cm/12¼"



14-4147-33
33.5 cm/13¼"



De Bakey-Bainbirdge



14-4148-15
15 cm/6"



14-4148-18
18 cm/7"



14-4148-15
15 cm/6"



14-4148-18
18 cm/7"



De Bakey
14-4149-20
20 cm/8"

Atrauma Cardiovascular Forceps ● EN
 Atrauma cardiovascular-klemmen ● DE
 Atrauma pinzas-clamps cardiovasculares ● ES



De Bakey

Aortic Aneurysm Clamps



De Bakey
 14-4150-28
 28 cm/11"

14-4151-30
 30 cm/12"



De Bakey

Aortic Clamps



Ochsner
14-4152-23
23.5 cm/9¼"



Dietrich
14-4153-21
21 cm/8¼"



De Bakey

Auricle Clamp



Harken



14-4154-01
 24 cm/9½"



14-4155-02
 24 cm/9½"



14-4156-03
 24 cm/9½"



14-4157-04
 24 cm/9½"



De Bakey

Bronchus Clamps

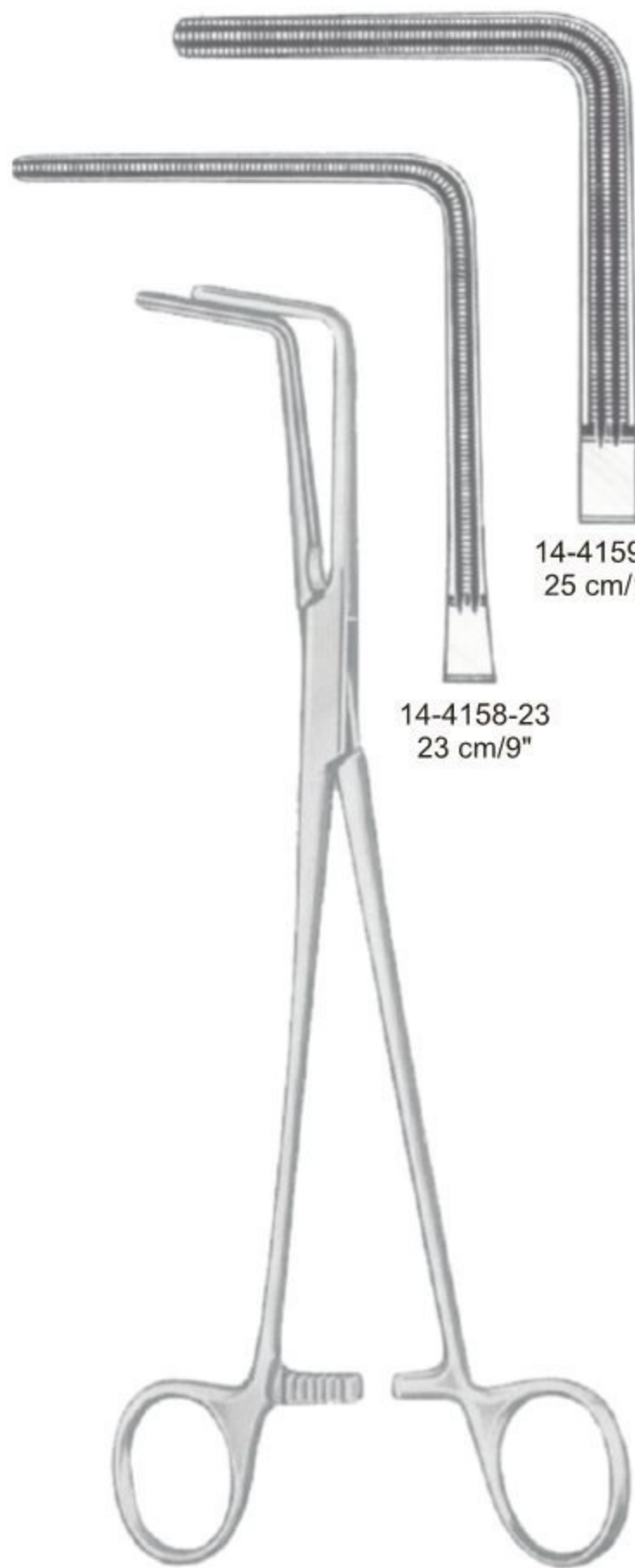

Lees

14-4159-25
 25 cm/10"

14-4158-23
 23 cm/9"



Lees
 14-4160-25
 25 cm/10"



De Bakey

Aortic Clamp

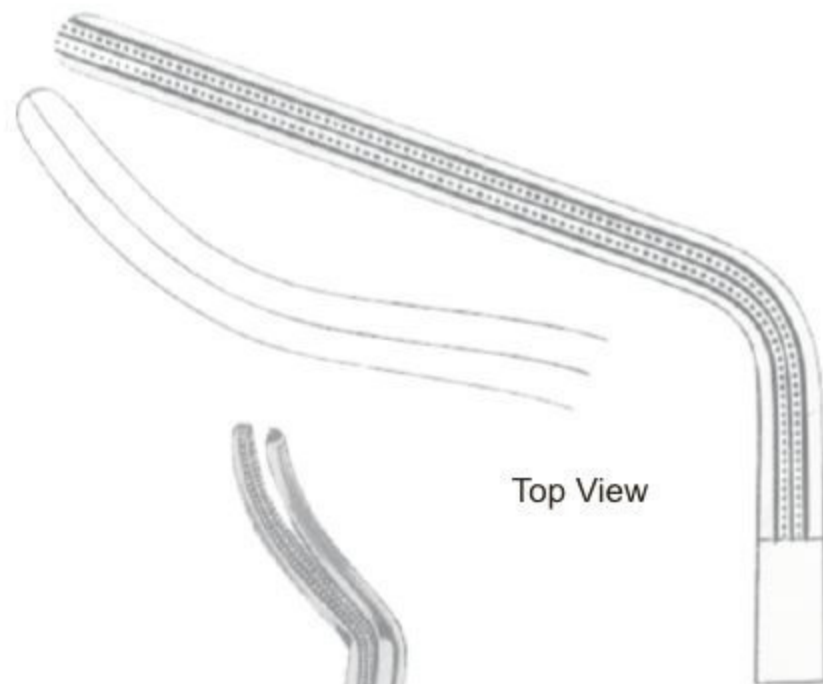

Top View



De Bakey
 14-4161-27
 27 cm/10½"

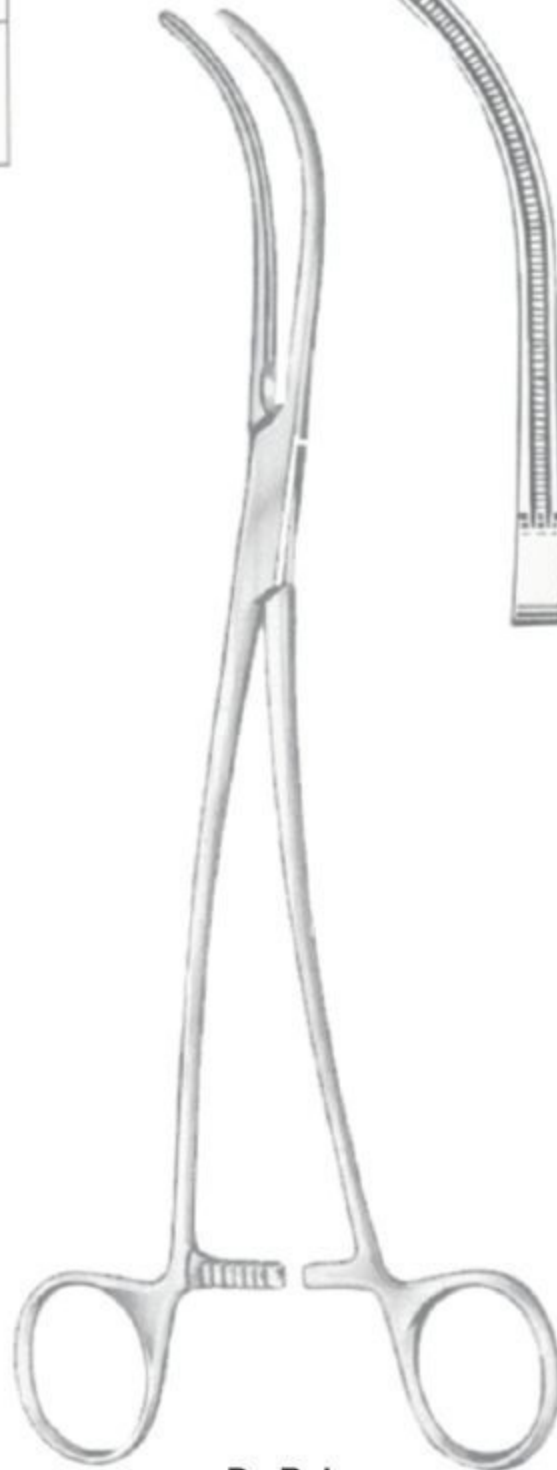

De Bakey
 14-4162-24
 24 cm/9½"

Ligature Clamps



De Bakey
 14-4163-24
 24 cm/9½"



De Bakey

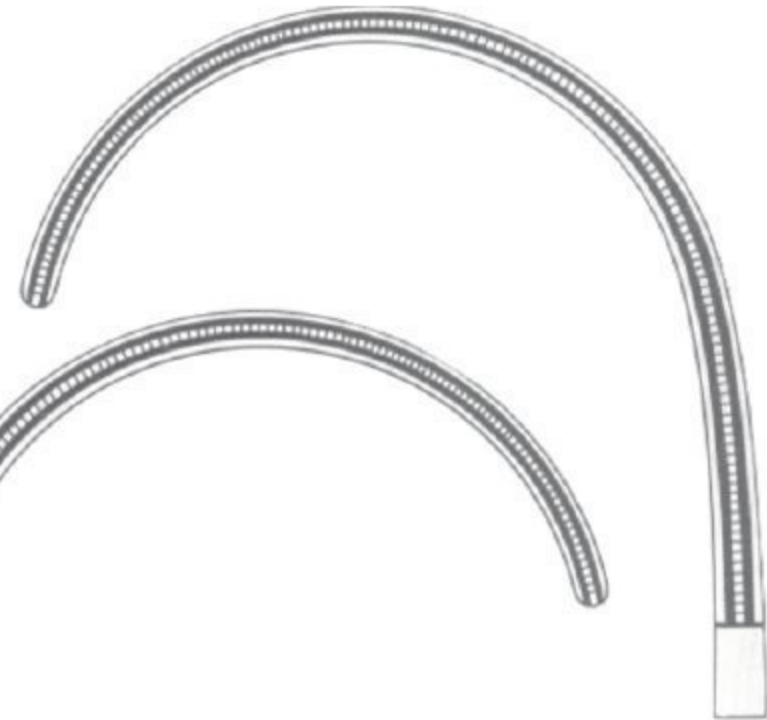

14-4167-02

14-4166-01

Ligature clamp,
 Aortic clamp



De Bakey
 14-4165-26
 26.5 cm/10½"

De Bakey-Semb
 14-4164-25
 25 cm/10"



Aortic clamp

Weber
 26 cm/10¼"

De Bakey-Semb



Satinsky/De Bakey

Tangential occlusion clamps



De Bakey



Set of 5 purchase.
14-4168-00

14-4168-20
20 cm/8"

14-4168-25
25 cm/10"

14-4168-26
26 cm/10¼"

14-4168-27
27 cm/10½"

14-4168-28
28 cm/11"



Glover

14-4169-01 19.5 cm/7¾"
 14-4169-02 21.0 cm/8¼"

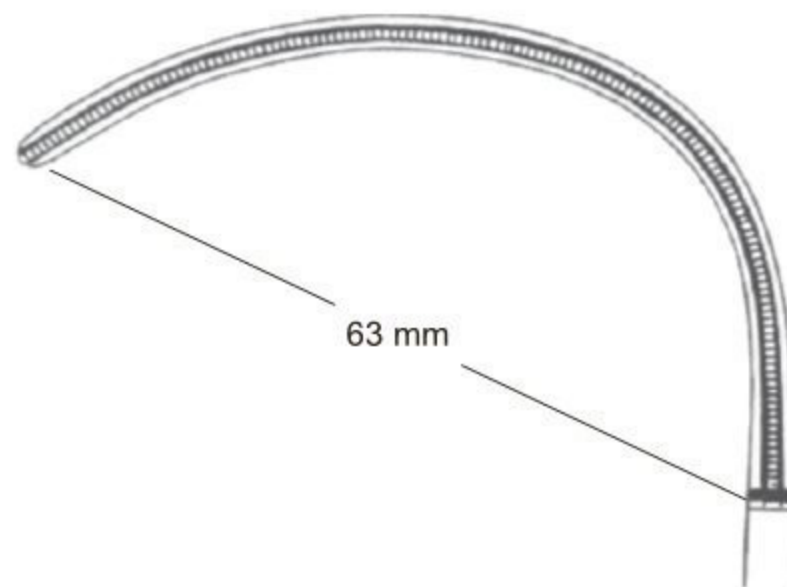

Anastomosis

63 mm

14-4169-01

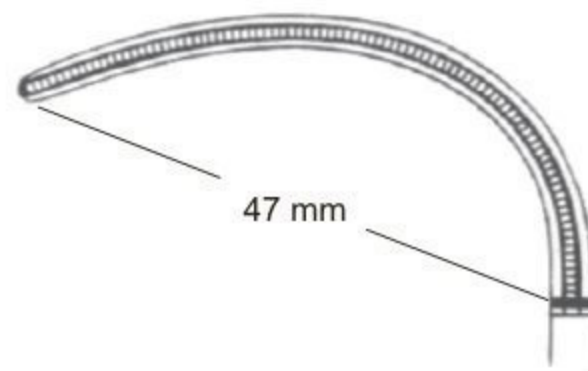

47 mm

14-4169-02

- EN —● Atrauma Cardiovascular Forceps
- DE —● Atrauma cardiovascular-klemmen
- ES —● Atrauma pinzas-clamps cardiovasculares



De Bakey



De Bakey
 14-4170-16
 16 cm/6 1/4"

Graduated

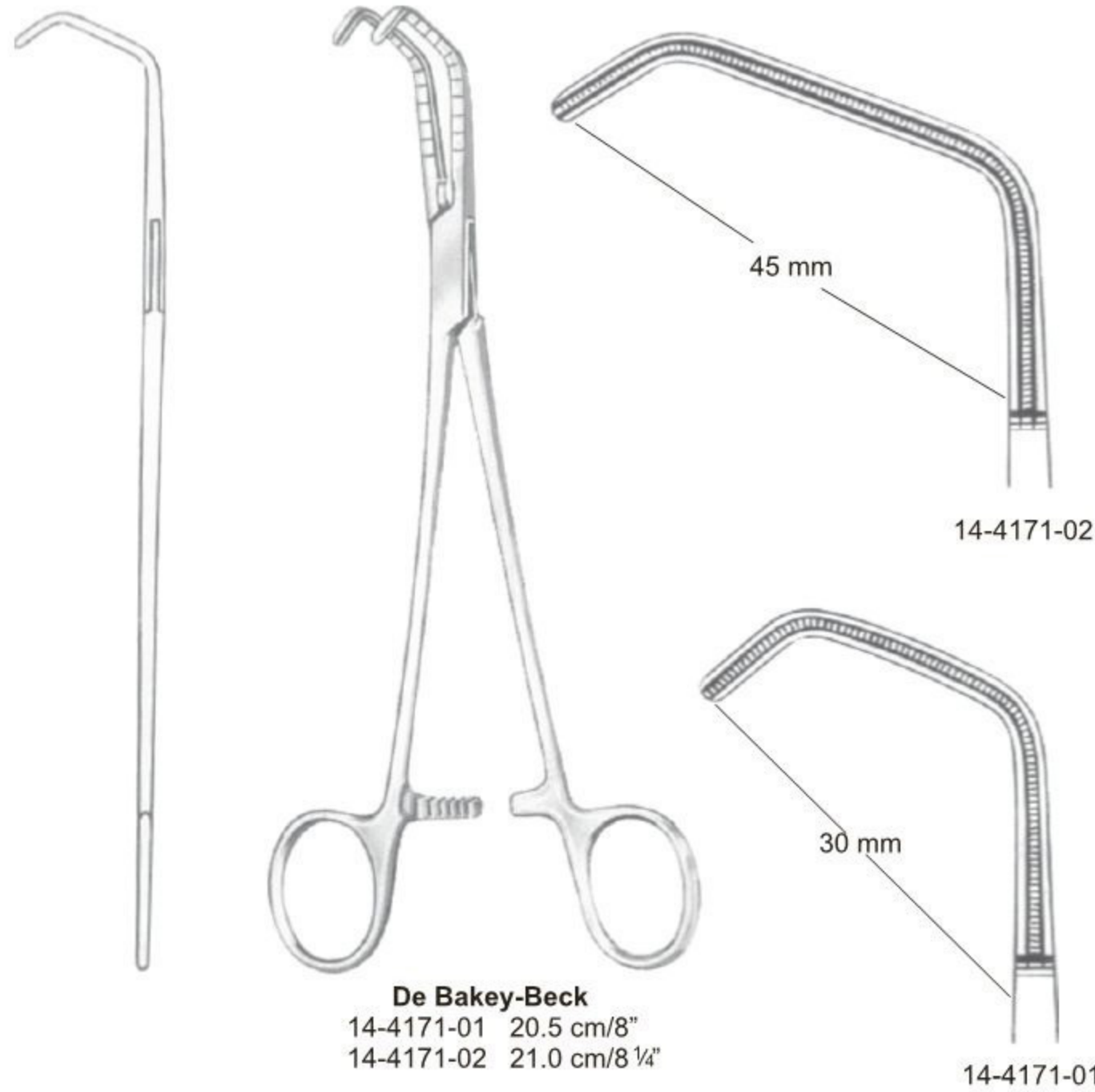

De Bakey-Beck
 14-4171-01 20.5 cm/8"
 14-4171-02 21.0 cm/8 1/4"



De Bakey



Lambert-Kay
 21 cm/8¼"



Aortic anastomosis clamps

14-4172-21



De Bakey
 14-4173-17
 17 cm/6¾"



Beck
 14-4174-17
 17 cm/6¾"

- EN —● Atrauma Cardiovascular Forceps
- DE —● Atrauma cardiovascular-klemmen
- ES —● Atrauma pinzas-clamps cardiovasculares



De Bakey



Multi purpose clamps

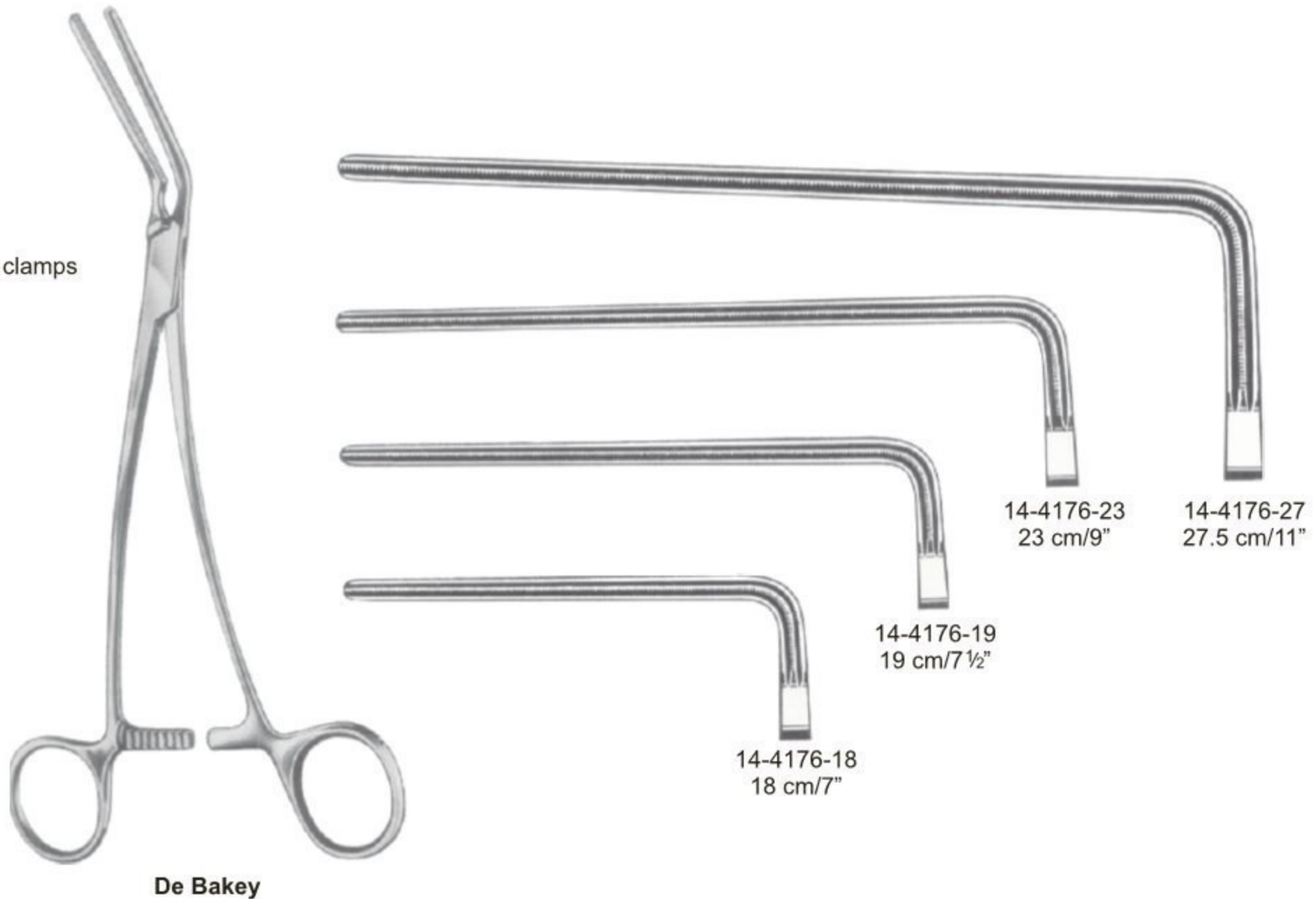

- Atrauma Cardiovascular Forceps ● EN
- Atrauma cardiovascular-klemmen ● DE
- Atrauma pinzas-clamps cardiovasculares ● ES



Aortic anastomosis clamps

Morris-De Bakey

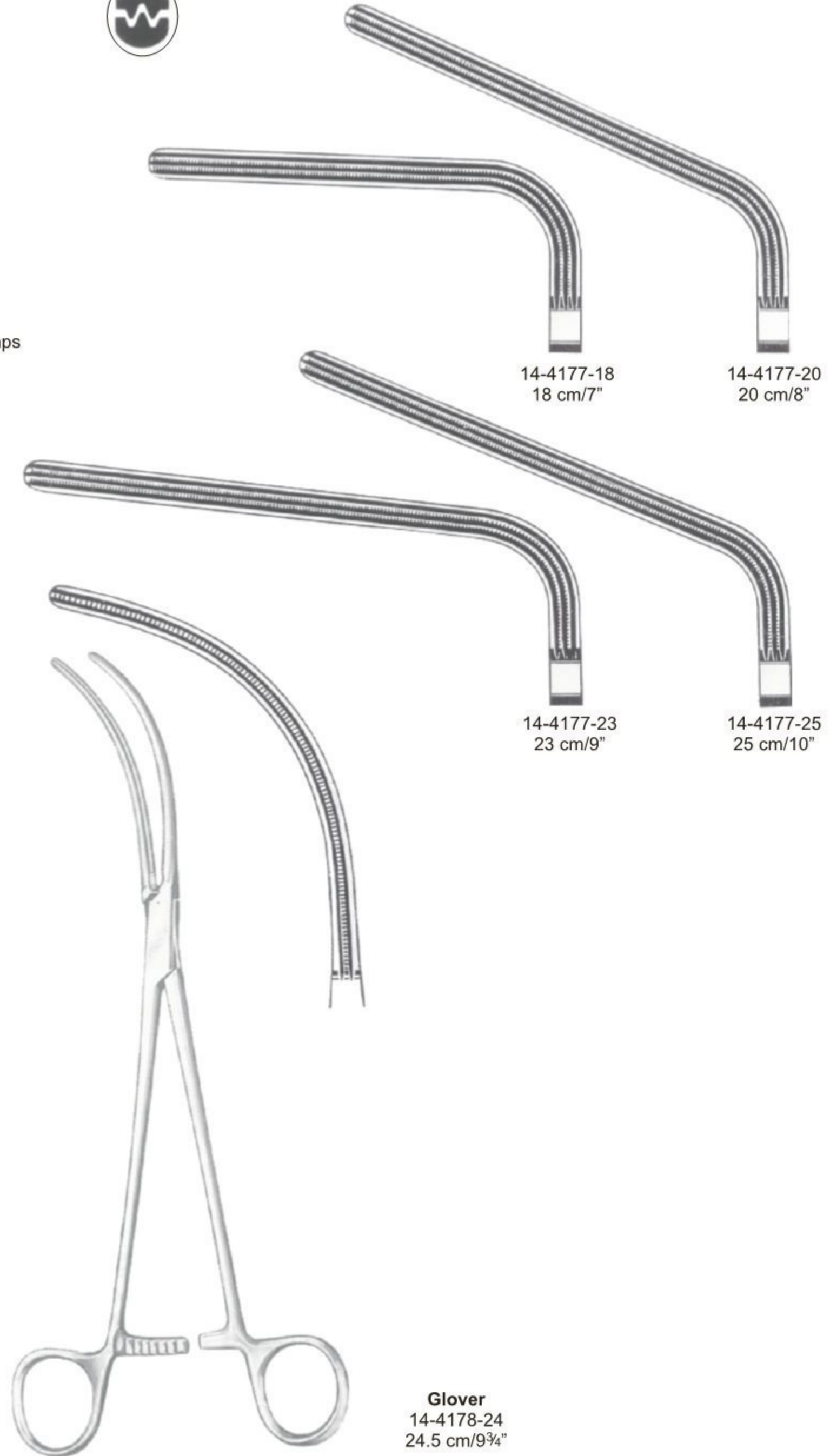

14-4177-18
 18 cm/7"

14-4177-20
 20 cm/8"

14-4177-23
 23 cm/9"

14-4177-25
 25 cm/10"



Glover
 14-4178-24
 24.5 cm/9¾"

- EN —● Atrauma Cardiovascular Forceps
- DE —● Atrauma cardiovascular-klemmen
- ES —● Atrauma pinzas-clamps cardiovasculares

Aorta aneurysm clamps



De Bakey-Bahnson



De Bakey



14-4179-24
24.5 cm/9¾"



14-4179-25
25.5 cm/10"



14-4179-26
26.5 cm/10½"

Coarctation clamps



Straight	cm/in	Curved
14-4180-21	21.5 cm/8½"	14-4181-21
14-4180-23	23.0 cm/9"	14-4181-23
14-4180-27	27.0 cm/10½"	14-4181-27
14-4180-31	31.5 cm/12½"	14-4181-31

Multi purpose clamps



De Bakey



De Bakey-Rankin



14-4182-16
16 cm/6¼"

14-4182-16
16 cm/6¼"



Cooley

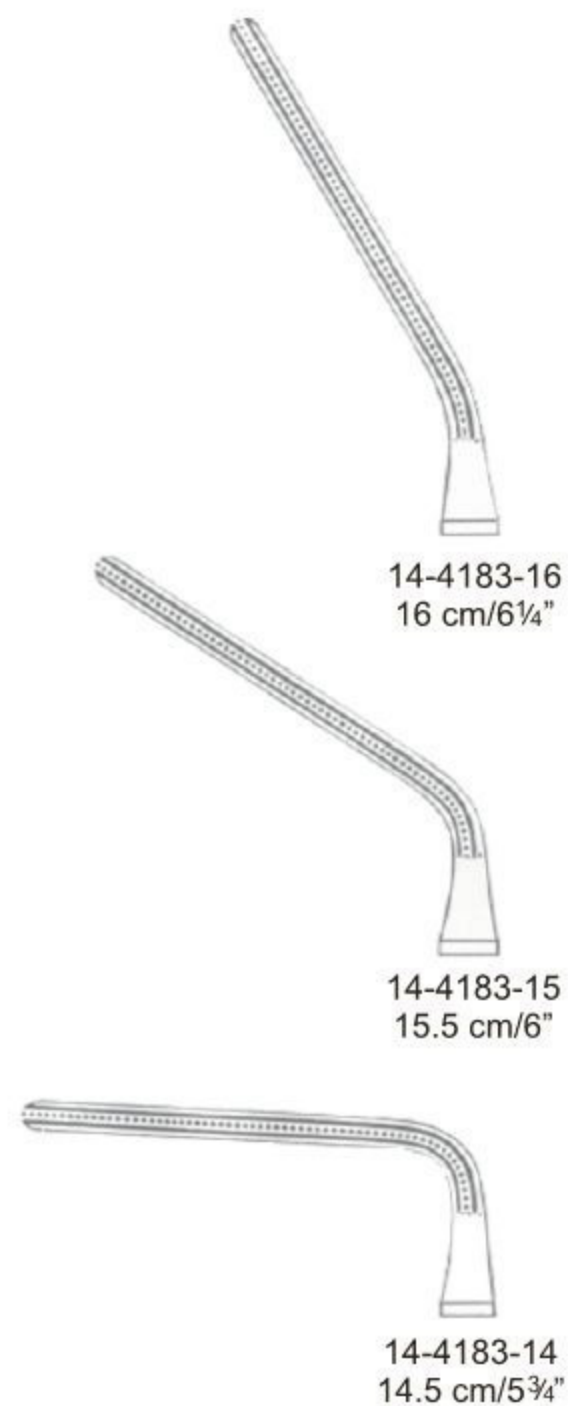

14-4183-16
16 cm/6¼"

14-4183-15
15.5 cm/6"

14-4183-14
14.5 cm/5¾"



De Bakey
14-4184-17
17 cm/6¾"

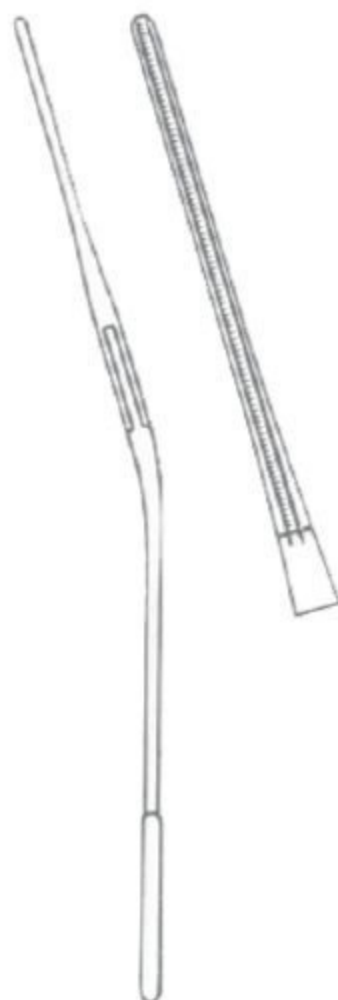

14-4185-17



14-4186-17



14-4187-17



De Bakey

Ligature Clamps

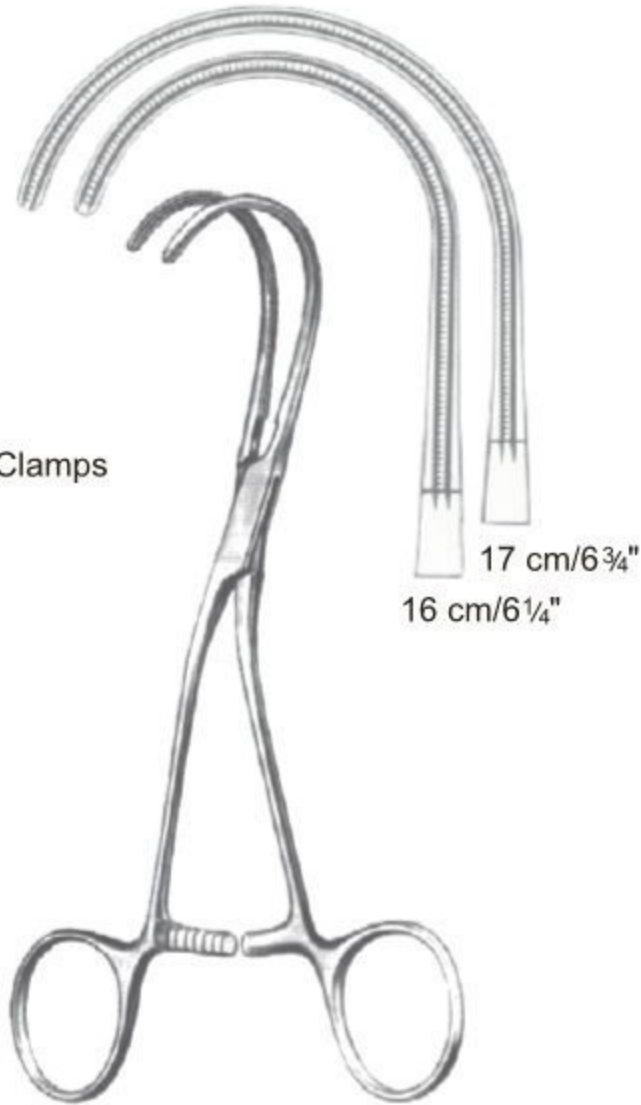

14-4188-16 16cm/6¼"
 14-4188-17 17cm/6¾"



Derra-De Bakey
 17 cm/6¾"

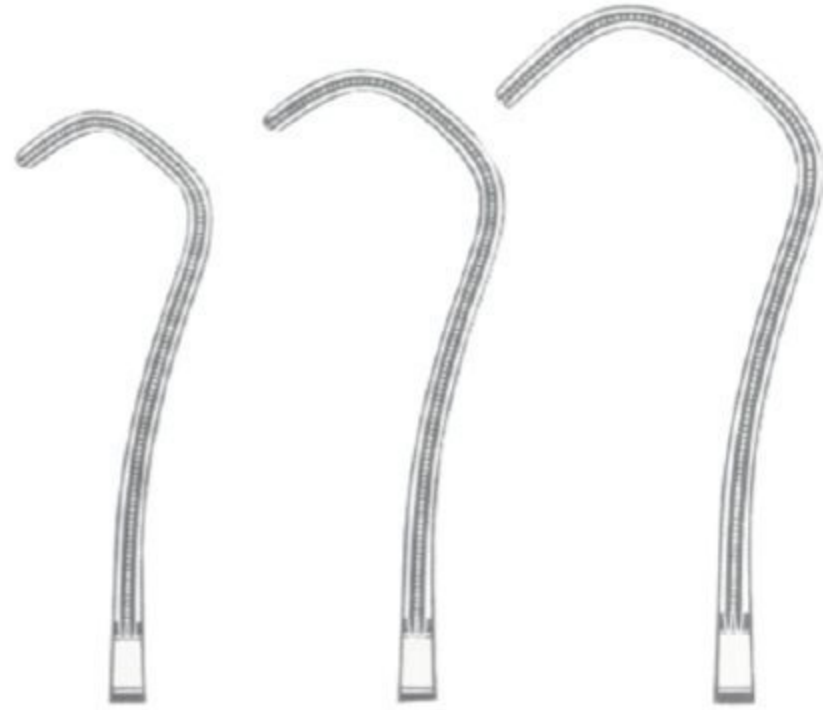

14-4189-01 14-4189-02 14-4189-03

Anastomosis Clamps

Profunda Clamps



Gregory



14-4190-14
 14 cm/5½"

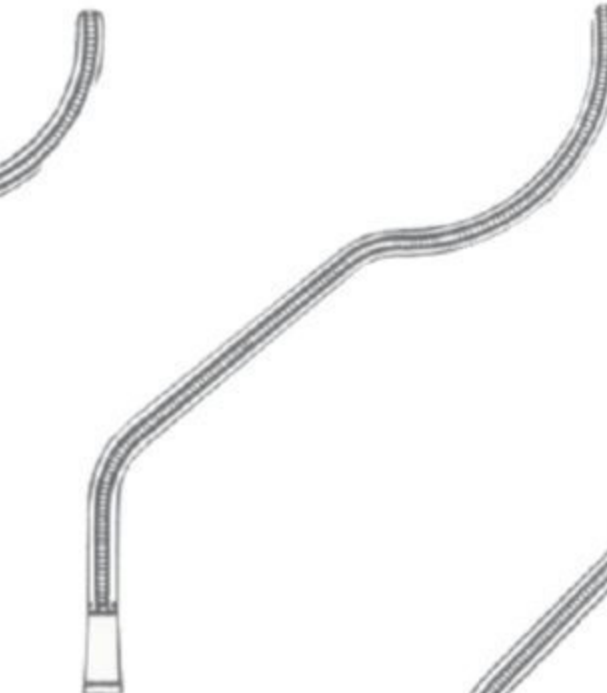

14-4190-16
 16 cm/6¼"

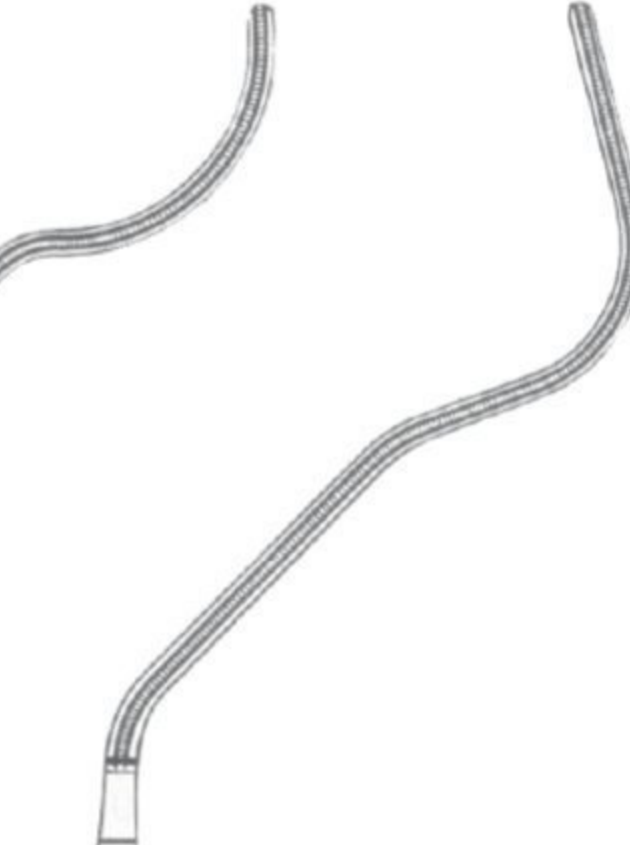

14-4190-18
 18 cm/7"



Cooley

Coarctation Clamps



Cooley
 14-4191-17
 17 cm/6¾"



14-4192-17
 17 cm/6¾"



14-4193-17
 17 cm/6¾"

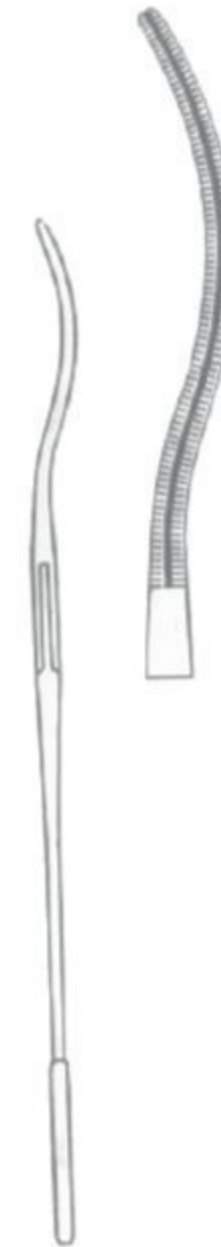

14-4194-17
 17 cm/6¾"



Cooley
 14-4195-20
 20 cm/8"



Cooley



Cooley



14-4196-03
 17 cm/6 3/4"

14-4197-02
 15.5 cm/6"



14-4198-01
 15 cm/6"



Cooley
 14-4199-17
 17 cm/6 3/4 "

Anastomosis clamps



Cooley



Cooley



14-4200-01
 16.5 cm/6½"

14-4200-02
 16.5 cm/6½"

14-4200-03
 17.5 cm/7"

29-0980714-4200
 17.5 cm/7"

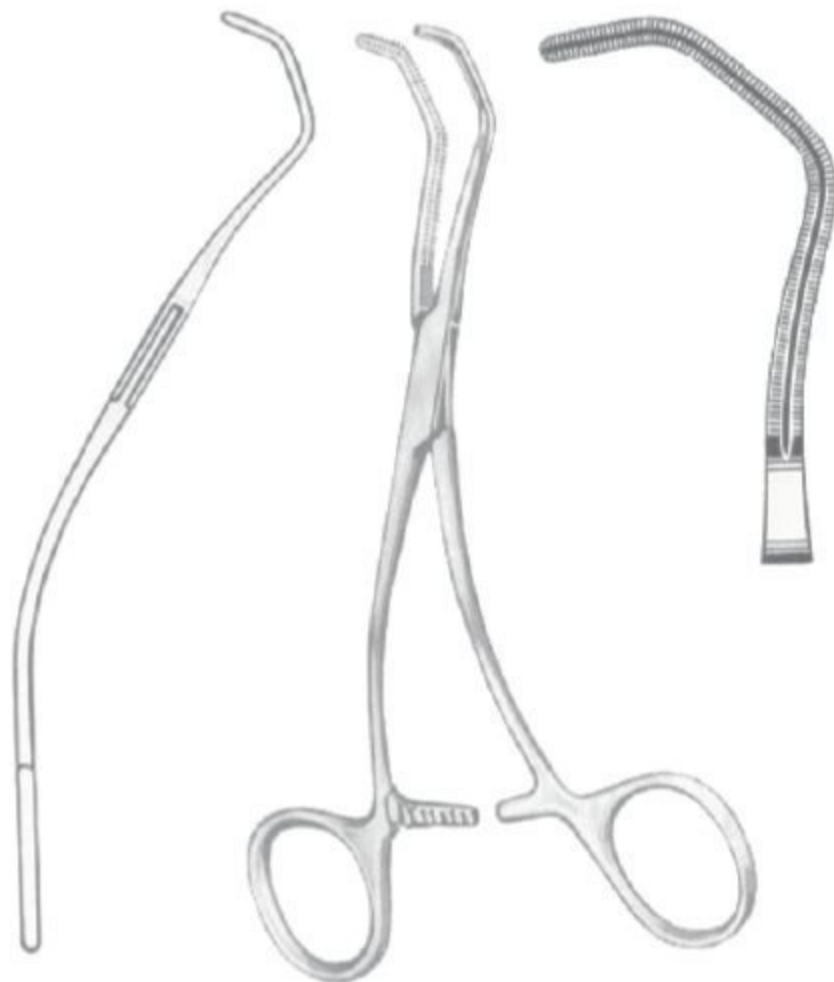

Cooley
 14-4201-16
 16 cm/6¼"



Beck
 14-4202-17
 17 cm/6¾"



Cooley



Cooley-Derra



14-4203-16
 16 cm/6 1/4"



14-4203-17
 17 cm/6 3/4"



14-4203-18
 18 cm/7"



Cooley
 14-4204-16 16 cm/6 1/4"
 14-4204-17 17 cm/6 3/4"

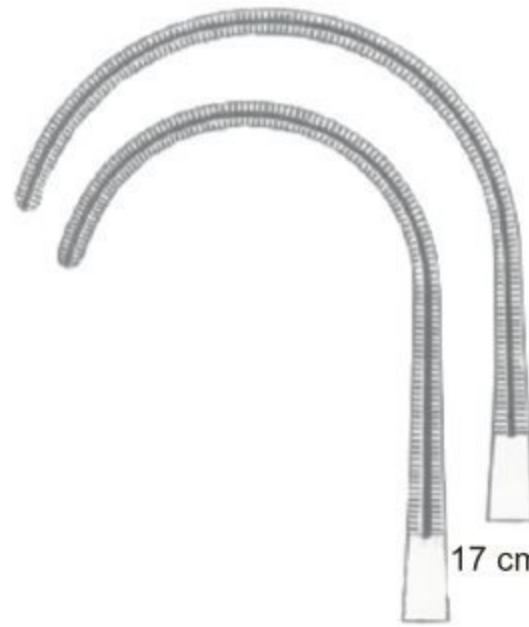

17 cm/6 3/4"
 16 cm/6 1/4"

Ligature clamps



Cooley



Cooley
 14 cm/5½"



Cooley
 14-4207-14
 14 cm/5½"



Cooley
 14-4208-14
 14 cm/5½"



Cooley
 14-4209-14
 14 cm/5½"



Cooley
 14-4210-01
 25 cm/10"



Cooley
 14-4211-02
 33 cm/13"



Cooley
 14-4212-03
 30 cm/12"



Cooley
 14-4213-04
 30 cm/12"



Cooley
 14-4214-05
 35 cm/13¾"

Tourniquets



Rumel-Belmont
 14-4215-32 3.2 mm Ø
 14-4215-64 6.4 mm Ø

Dilators ● EN
Dilatatoren ● DE
Dilatadores ● ES

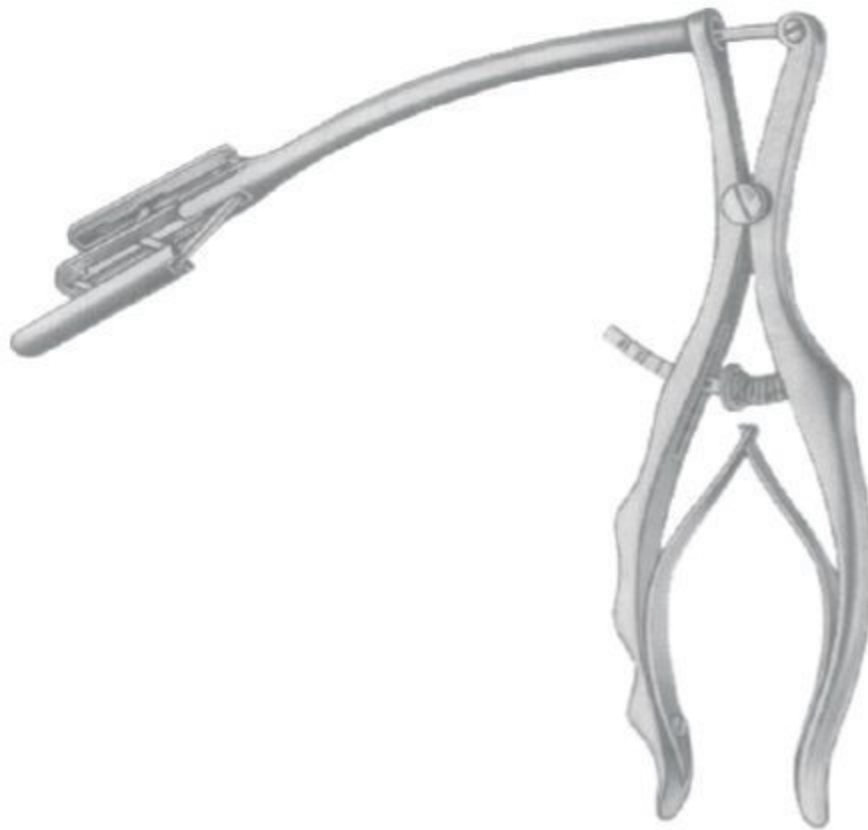

Cooley
14-4216-00



Gerbode
14-4217-00



Tubbs
14-4218-00



De Bakey

mm Ø	19 cm/7 1/2"	35 cm/14"
0.5	14-4219-05	14-4220-05
1.0	14-4219-10	14-4220-10
1.5	14-4219-15	14-4220-15
2.0	14-4219-20	14-4220-20
2.5	14-4219-25	14-4220-25
3.0	14-4219-30	14-4220-30
3.5	14-4219-35	14-4220-35
4.0	14-4219-40	14-4220-40
4.5	14-4219-45	14-4220-45
5.0	14-4219-50	14-4220-50
7.0	14-4219-70	14-4220-70
9.0	14-4219-90	14-4220-90

Malleable

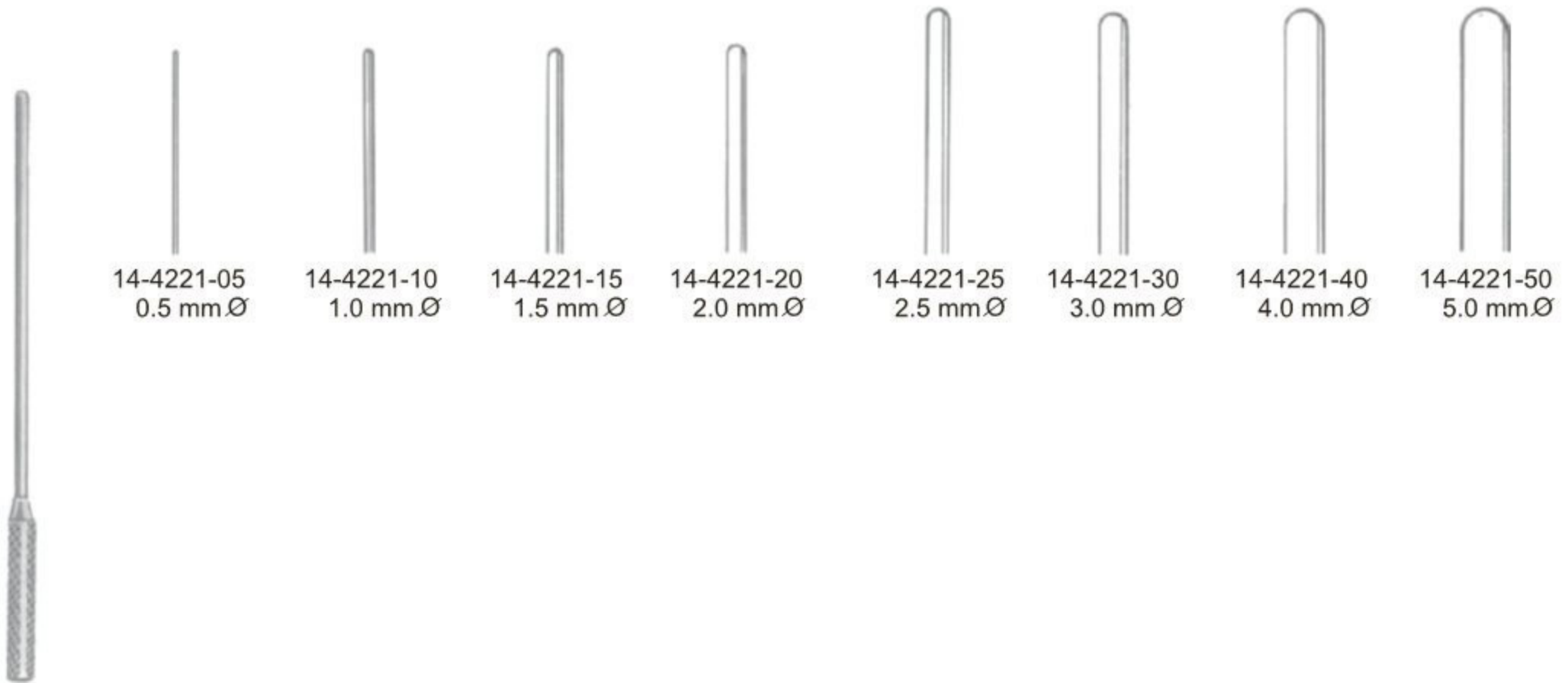

Cooley
 13 cm/5"

Rib Shears, Sternum Scissors and Sternum Chisels ● EN

Rippenscheren, Sternumschere, Sternummeißel ● DE

Costótomos, Tijera de esternón, cincel de esternón ● ES



Sauerbruch
14-4222-24 24 cm/9½"
14-4222-26 26 cm/10¼"



Giertz-Stille
14-4223-27
27 cm/10½"

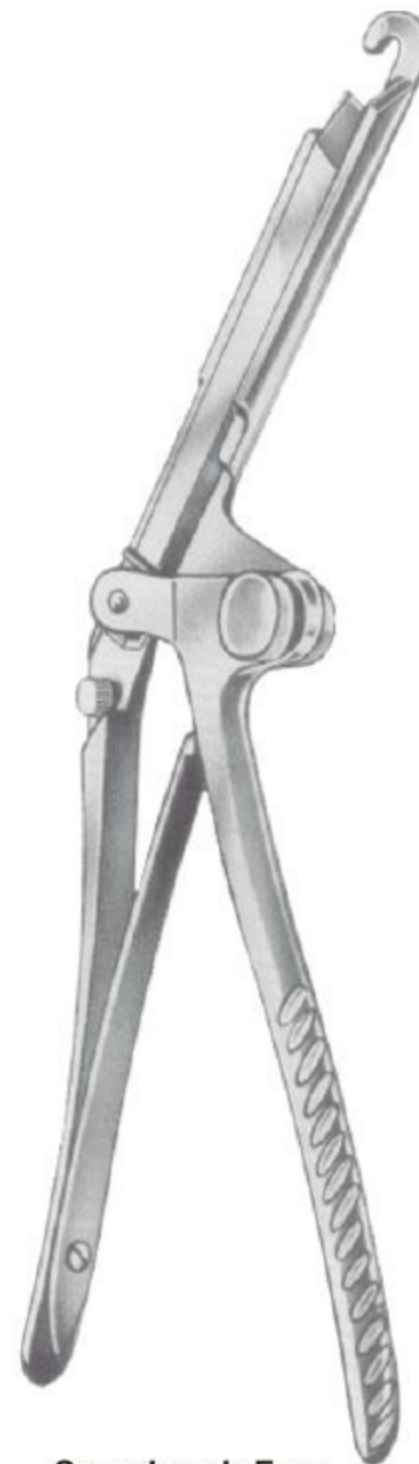

Sauerbruch-Frey
14-4224-36
36 cm/14"



Bethune
14-4225-34
34 cm/13½"

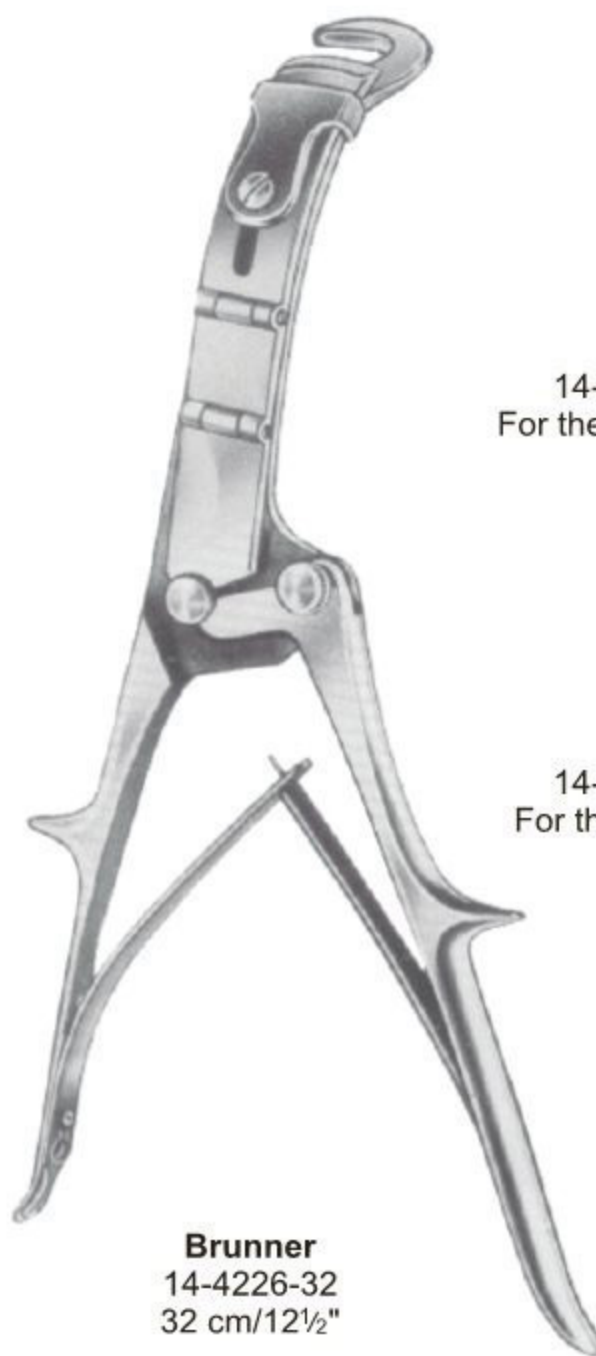

Brunner
14-4226-32
32 cm/12½"

14-4226-32
For the Right Hand

14-4227-32
For the left Hand



Lebsche
14-4228-24
24.5 cm/9¾"



Finocchietto-Baby

	a	b	c
14-4229-00	18 mm	21 mm	105 mm

Scheme of Dimensions

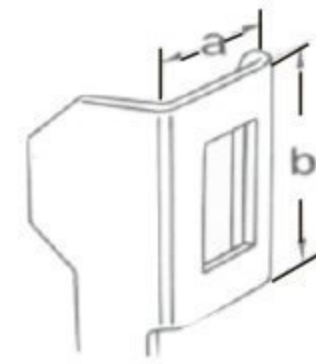

Size of Blades

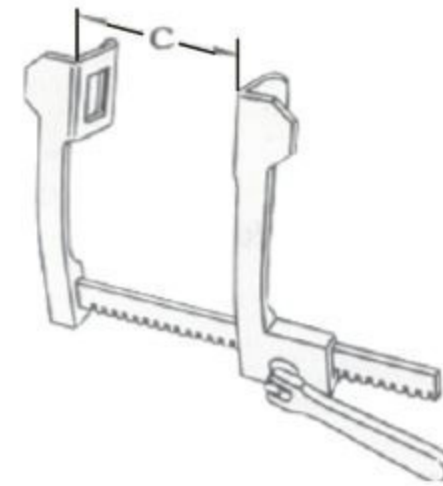

Total Spread



Finocchietto

	a	b	c
14-4230-01	36 mm	45 mm	165 mm
14-4230-02	44 mm	65 mm	200 mm
14-4230-03	44 mm	65 mm	250 mm
14-4230-04	44 mm	65 mm	300 mm
14-4230-05	65 mm	65 mm	200 mm
14-4230-06	65 mm	65 mm	250 mm
14-4230-07	65 mm	65 mm	300 mm

- Rib Spreaders ● EN
- Rippensperrer ● DE
- Separadores costales ● ES

With 2 Pairs of Interchangeable Blades



Finocchietto-Burford

Blade Opening
 14-4231-01 200 mm/8"
 14-4231-02 250 mm/10"
 14-4231-03 305 mm/12"



Tuffier



Haight

	a	b	c
14-4233-00	30 mm	30 mm	115 mm

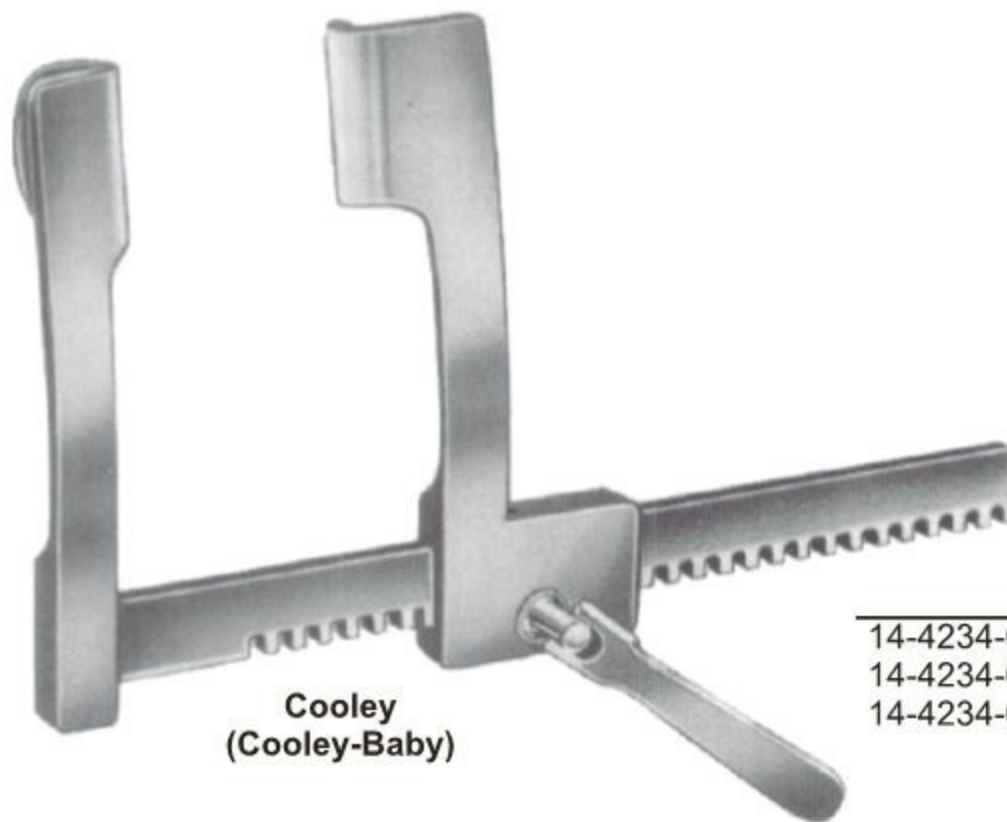

**Cooley
 (Cooley-Baby)**

	a	b	c
14-4234-01	15 mm	30 mm	75 mm
14-4234-02	21 mm	45 mm	145 mm
14-4234-03	32 mm	50 mm	190 mm

Rib Spreaders ● EN
 Rippensperrer ● DE
 Separadores costales ● ES

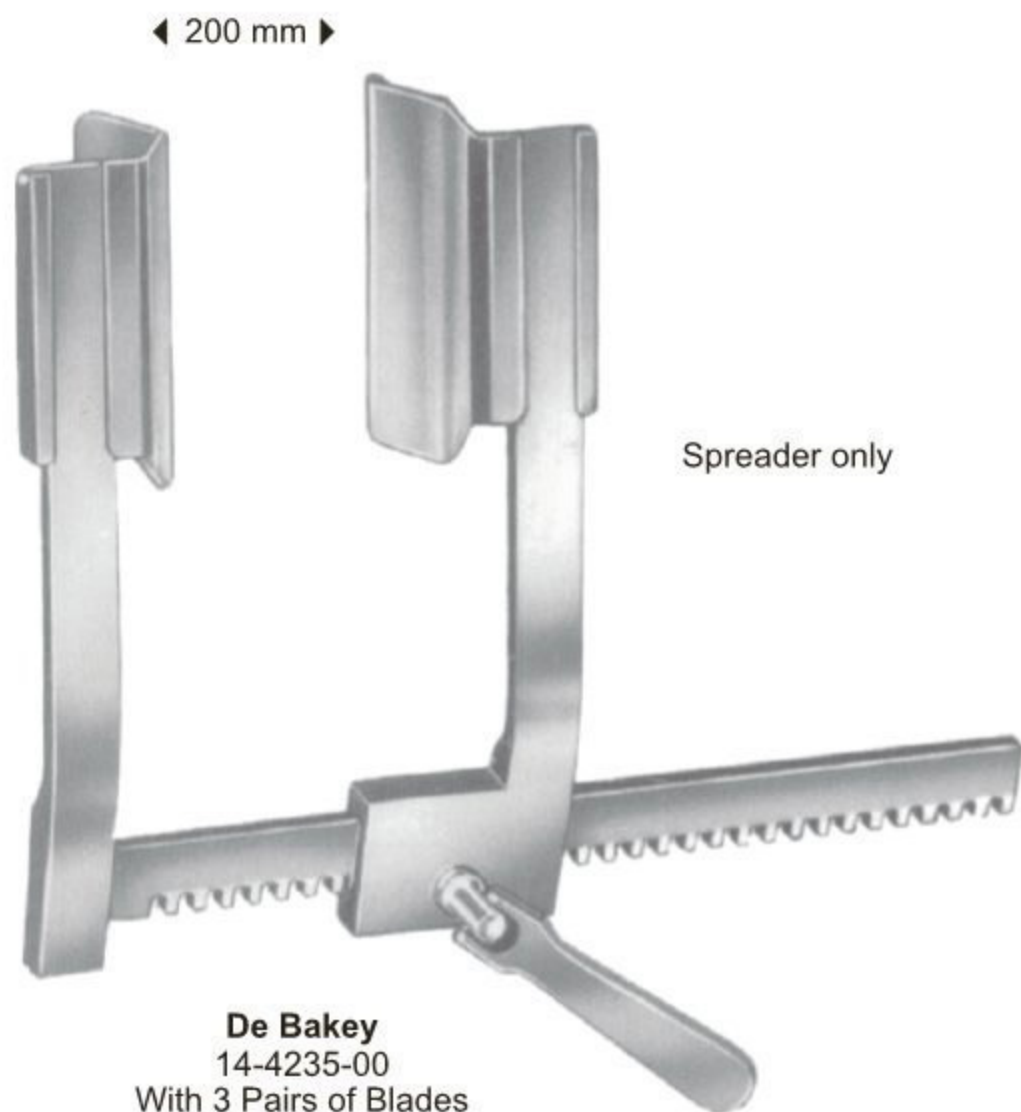

De Bakey
 14-4235-00
 With 3 Pairs of Blades
 14-4235-01
 14-4235-02
 14-4235-03

Spreader only



14-4235-01
 60 x 60 mm



14-4235-02
 50 x 80 mm

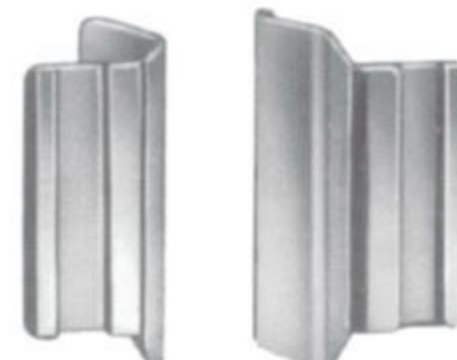

14-4235-03
 40 x 100 mm



14-4235-04
 80 x 60 mm



14-4235-05
 50 x 66 mm

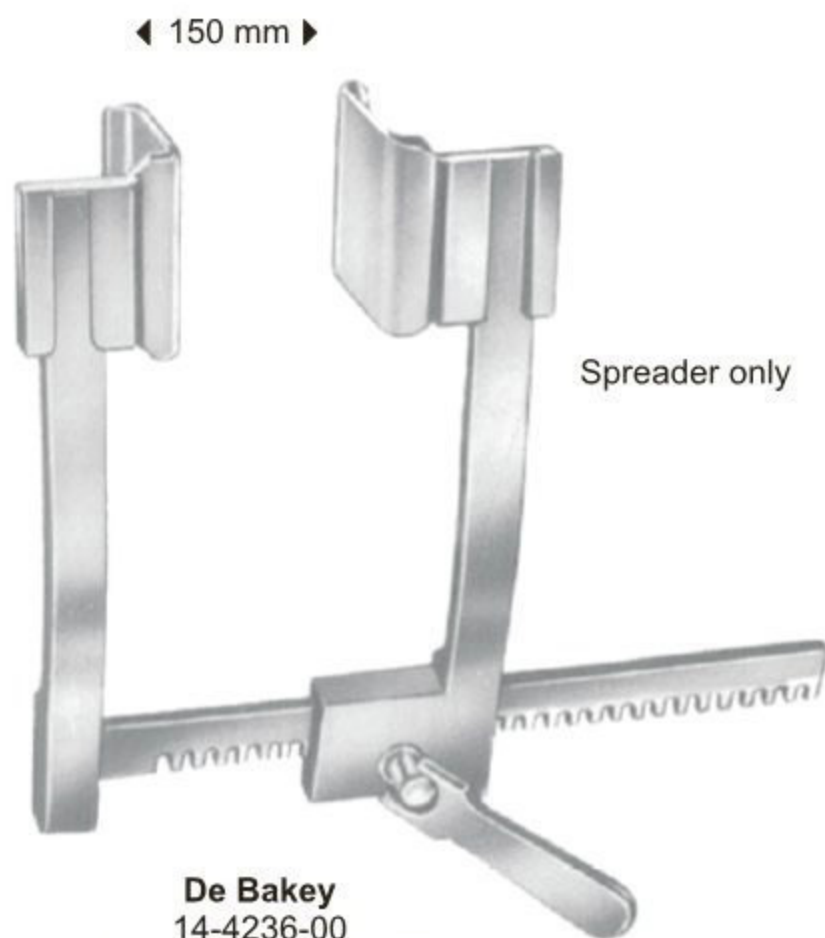

De Bakey
 14-4236-00
 With 3 Pairs of Blades

Spreader only



14-4236-01
 30 x 30 mm



14-4236-02
 40 x 40 mm



14-4236-03
 50 x 50 mm

◀ Fig. 1 15 cm/6" ▶
 ▶ Fig. 2 20 cm/8" ▶



Morse-Favaloro
 Fig. 1 14-4237-01
 Fig. 2 14-4237-02

75 x 75 mm

42 x 65 mm

Thoracic Retractor



(Mercedes-Retractor)
 14-4238-00
 Complete

Rib Spreaders ● EN
 Rippensperrer ● DE
 Separadores costales ● ES

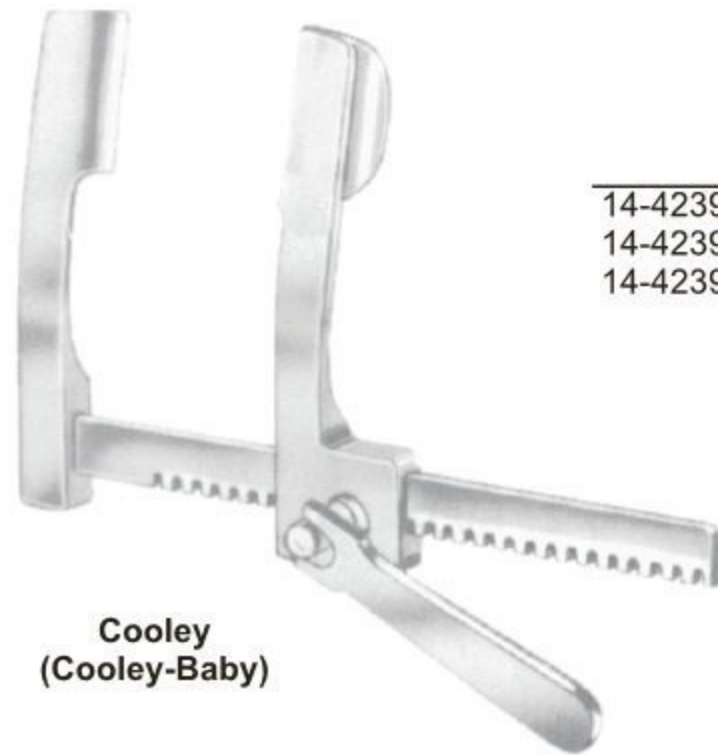

**Cooley
 (Cooley-Baby)**

	a	b	c
14-4239-01	12 mm	17 mm	75 mm
14-4239-02	16 mm	30 mm	105 mm
14-4239-03	37 mm	49 mm	200 mm

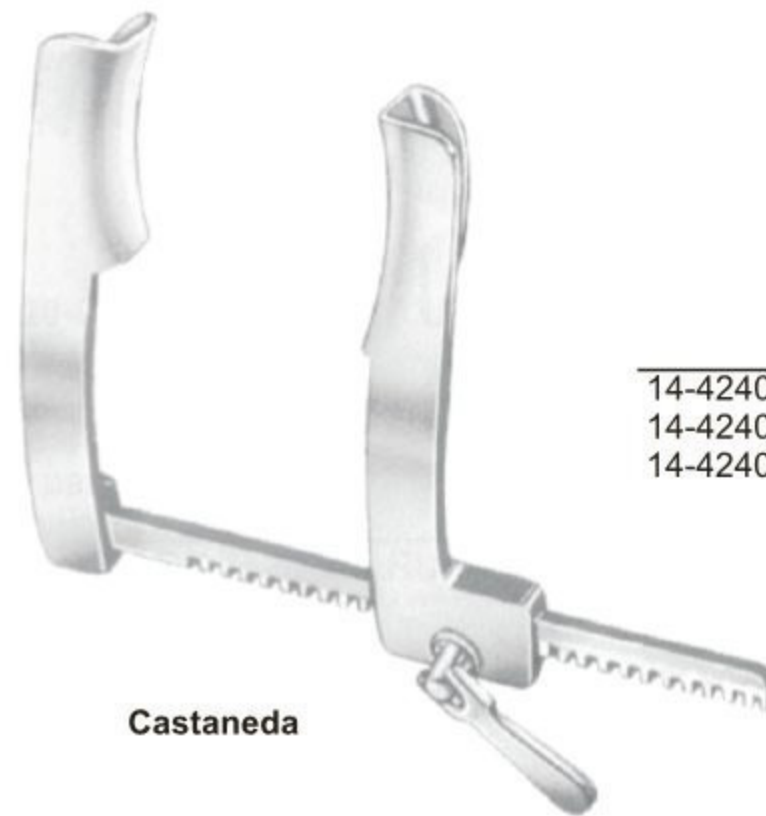

Castaneda

	a	b	c
14-4240-01	10.5 mm	32 mm	65 mm
14-4240-02	12 mm	45 mm	70 mm
14-4240-03	15 mm	60 mm	120 mm



Finocchietto-Baby-Haight

	a	b	c
14-4241-01	15 mm	15 mm	75 mm
14-4241-02	31 mm	31 mm	100 mm
14-4241-03			



Finocchetto

	a	b	c
14-4242-01	38 mm	44 mm	135 mm
14-4242-02	52 mm	62 mm	135 mm
14-4242-03	85 mm	65 mm	135 mm



Burford
 With 2 Pairs of Blades

For Child	a	b	c
	48 mm	42 mm	135 mm
14-4243-00	34 mm	42 mm	135 mm
14-4243-01	65 mm	62 mm	180 mm
	47 mm	62 mm	
14-4243-02	65 mm	62 mm	260 mm
	47 mm	62 mm	
14-4243-03	65 mm	62 mm	300 mm
	47 mm	62 mm	

Rib Contractors, Lung Spatulas ●— EN
 Rippenkontraktoren, Lungenspatel ●— DE
 Aproximadores para costillas, Espátula pulmonar ●— ES



Lemmon
 14-4244-18
 18 cm/7"



Sellors
 14-4245-19
 19 cm/7½"



Bailey-Baby
 14-4246-14
 14 cm/5½"



Bailey
 14-4247-16
 16 cm/6¼"



Bailey-Gibbon
 14-4248-16
 16 cm/6¼"



Allison
 14-4249-25 25.5 cm/10"
 14-4249-30 30.0 cm/12"

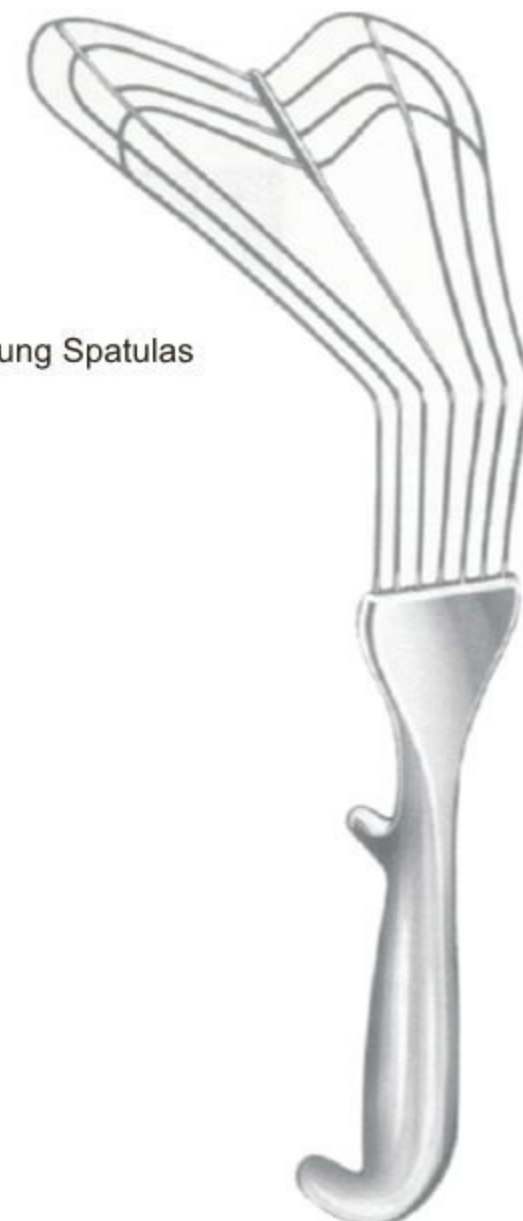

Lung Spatulas

14-4250-30
 30 cm/12"

- EN** Neurosurgery
- DE** Neurochirurgie
- ES** Neuro Cirugía

Page 358 to 388



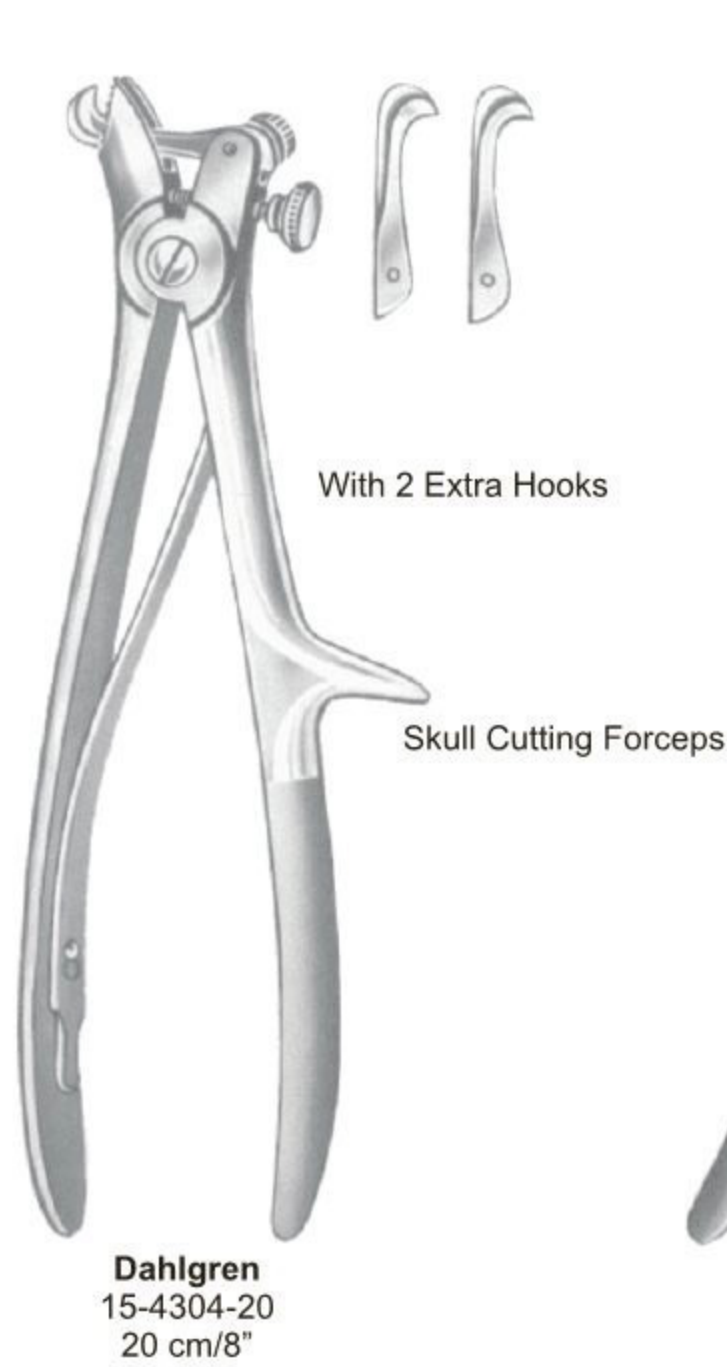

Cervical Traction Tongs ● EN
 Schädelhalter ● DE
 Pinzas de tracción craneal ● ES



Crutchfield
 15-4306-00



Crutchfield
 15-4307-00



15-4308-00



Crutchfield
 15-4309-00
 Complete With 2 Drills

Applying and Removing Forceps



Raney
15-4310-00
16 cm/6¼"



McKenzie
15-4311-15 15 cm/6"
15-4311-19 19 cm/7½"



Olivecrona-Tonnis
15-4312-14



Retractor Only
 15-4313-01
 15 cm/6"

Caspar
 15-4313-00

Retractor Complete With
 1 Blade Each
 15-4313-40
 15-4313-50



Retractor Only
 15-4314-01
 12 cm/4¾"

Caspar
 15-4314-00

Retractor Complete With
 1 Blade Each
 15-4314-40
 15-4314-50

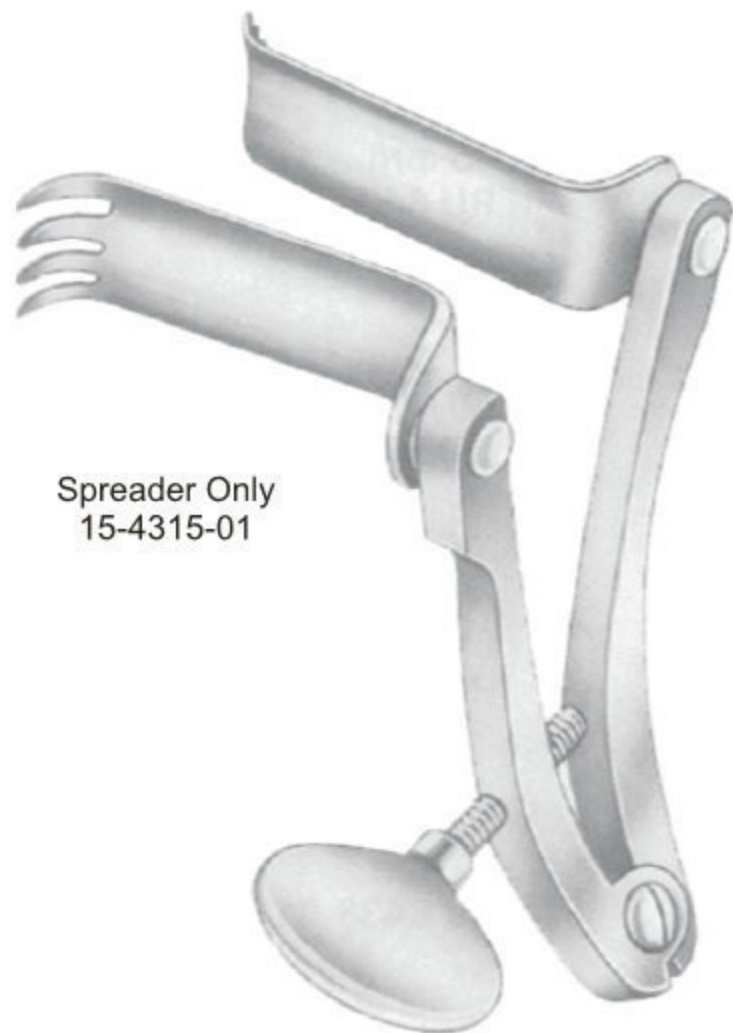

Spreader Only
 15-4315-01

Caspar
 15-4315-00
 Retractors Only
 Spreader Complete With
 1 Blade Each
 15-4315-45
 15-4315-60



Spreader Only
 15-4316-01

Caspar
 15-4316-00
 Spreader Only
 Retractor Complete With
 1 Blade Each
 15-4316-40
 15-4316-60

15-4317-01
 15 cm/6"
 Retractor only

Caspar
 15-4317-00
 15-4317-45
 15-4317-65
 Retractor complete with
 1 blade each



15-4318-01
 15 cm/6"
 Retractor only

Caspar
 15-4318-00
 15-4318-45
 15-4318-65
 Retractor adjustable, con
 1 blade each

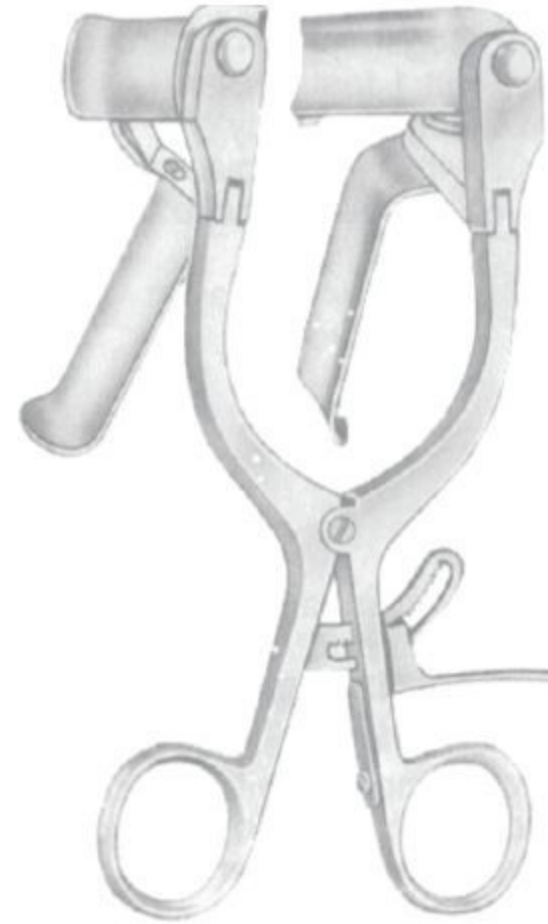

15-4319-01
 Retractor only
 with 1 fixed blade

Caspar
 15-4319-00
 Retractor complete,
 eith 5 blades

15-4319-40
 40 mm



15-4319-45
 45 mm



15-4319-50
 50 mm



15-4319-55
 55 mm



15-4319-60
 60 mm





15-4320-01
 Retractor only

Cloward
 15-4320-00
 25 cm/10"
 complete with 5 blades

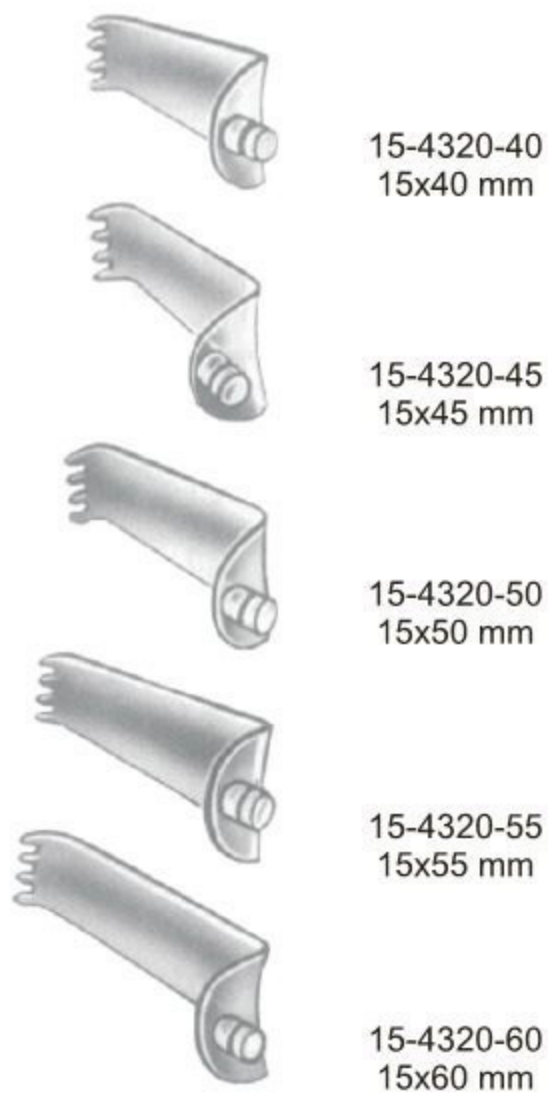

15-4320-40
 15x40 mm

15-4320-45
 15x45 mm

15-4320-50
 15x50 mm

15-4320-55
 15x55 mm

15-4320-60
 15x60 mm



15-4321-01
 Retractor only

Cloward
 15-4321-00
 15 cm/6"
 complete with 5 blades

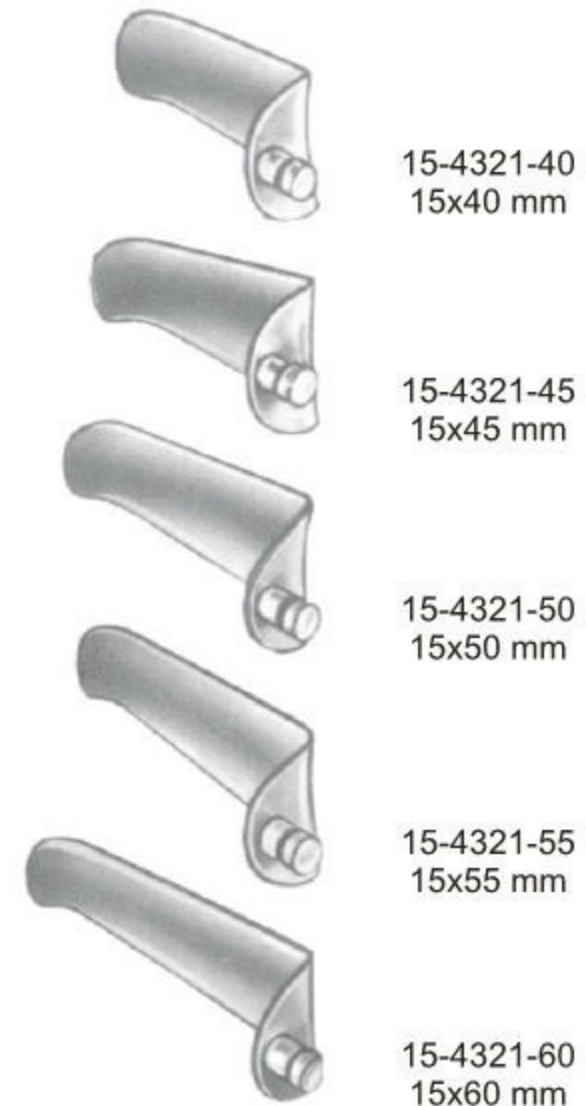

15-4321-40
 15x40 mm

15-4321-45
 15x45 mm

15-4321-50
 15x50 mm

15-4321-55
 15x55 mm

15-4321-60
 15x60 mm



Inge
 15-4322-16
 16 cm/6 1/4"



Inge
 15-4323-25
 27 cm/10 3/4"



Cloward
 15-4324-15
 15 cm/6"



Cloward
 15-4325-16
 16 cm/6 1/4"

Muscle blades



Frame
 15-4326-01

Hey
 15-4327-00
 15-4328-00
 23 cm/9"



15-4329-50
 20x50 mm



15-4329-60
 20x60 mm



15-4329-70
 20x70 mm

Vertebra-pins



15-4330-50
 50 mm



15-4330-60
 60 mm



15-4330-70
 70 mm



	Left-type	Right-type
50x10 mm	15-4331-01	15-4332-01
60x10 mm	15-4331-02	15-4332-02
70x10 mm	15-4331-03	15-4332-03
50x20 mm	15-4333-01	15-4334-01
60x20 mm	15-4333-02	15-4334-02
70x20 mm	15-4333-03	15-4334-03

Muscle Retractors ● EN
 Muscle Retraktoren ● DE
 Los retractoros del músculo ● ES

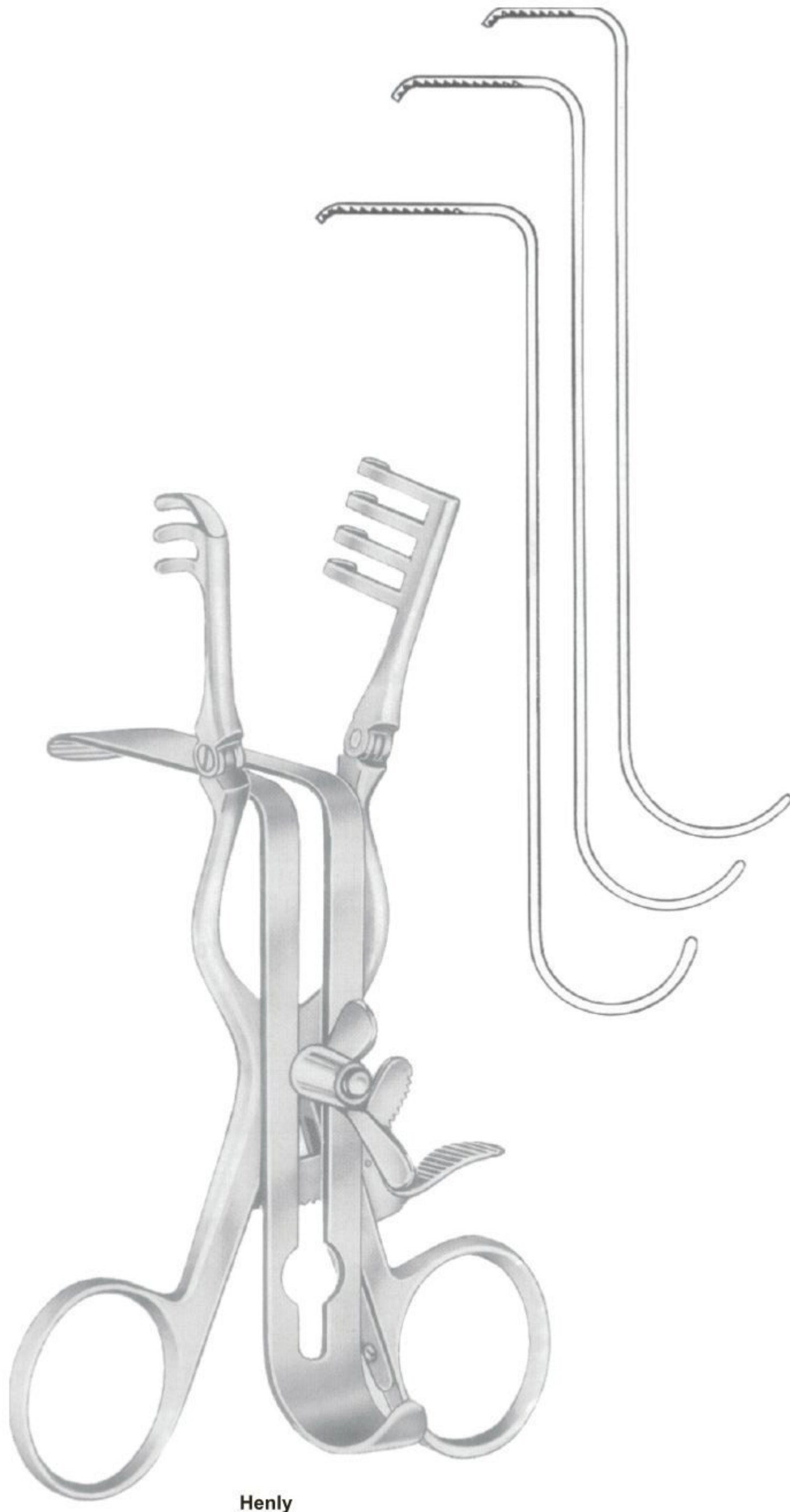

Henly

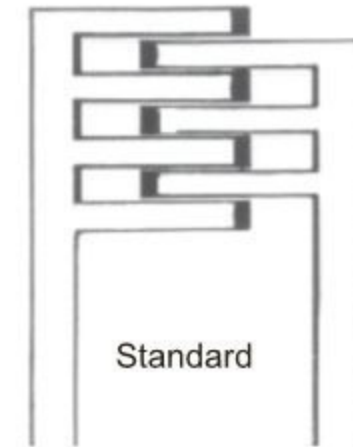

Standard

15-4335-00 Complete 15-4336-00
 14.5 cm/5¾" Consisting of 17 cm/6¾"

15-4335-01 Frame 15-4336-01
 15-4335-21 Centre Blades 15-4336-21
 15-4335-22 15-4336-22
 15-4335-23 15-4336-23

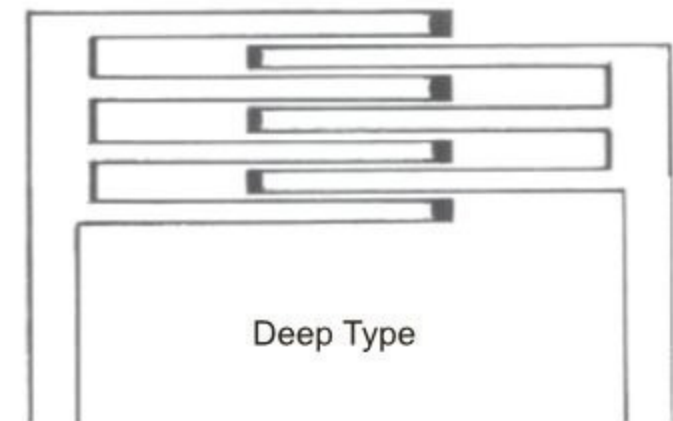

Deep Type

15-4337-00 Complete 15-4338-00
 14.5 cm/5¾" Consisting of 17 cm/6¾"

15-4337-01 Centre Blades 15-4338-01
 15-4337-21 15-4338-21
 15-4337-22 15-4338-22
 15-4337-23 15-4338-23

- EN —● Dura Dissectors and Elevators
- DE —● Dura-Dissektoren, Elevatoren
- ES —● Disecadores para dura-madre, Elevadores



Davis
 15-4339-24
 24.5 cm/9 3/4"



Toennis
 15-4340-25
 25 cm/10"



Frazier
 15-4341-15



Hoer
 15-4342-15



Hoer
 15-4343-15

15 cm/6"



Love-Adson
 15-4344-16
 16 cm/6 1/2"

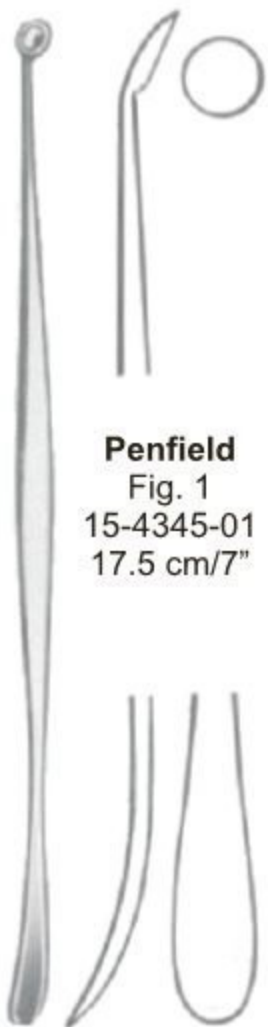

Penfield
 Fig. 1
 15-4345-01
 17.5 cm/7"



Penfield
 Fig. 2
 15-4346-02
 19.5 cm/7 3/4"

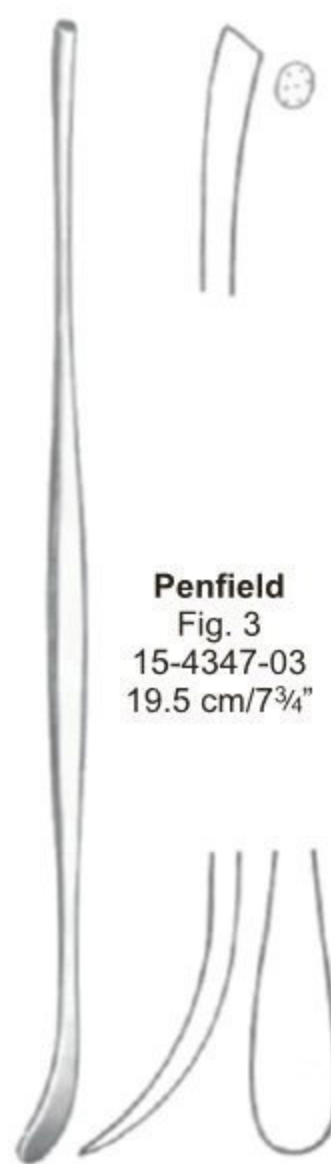

Penfield
 Fig. 3
 15-4347-03
 19.5 cm/7 3/4"



Penfield
 Fig. 4
 15-4348-04
 21.5 cm/8 1/2"



Penfield
 Fig. 5
 15-4349-05
 29 cm/11 1/2"

Dura Dissectors and Elevators ●— EN
 Dura-Dissektoren, Elevatoren ●— DE
 Disecadores para dura-madre, Elevadores ●— ES



Sachs
 15-4350-21
 21 cm/8¼"

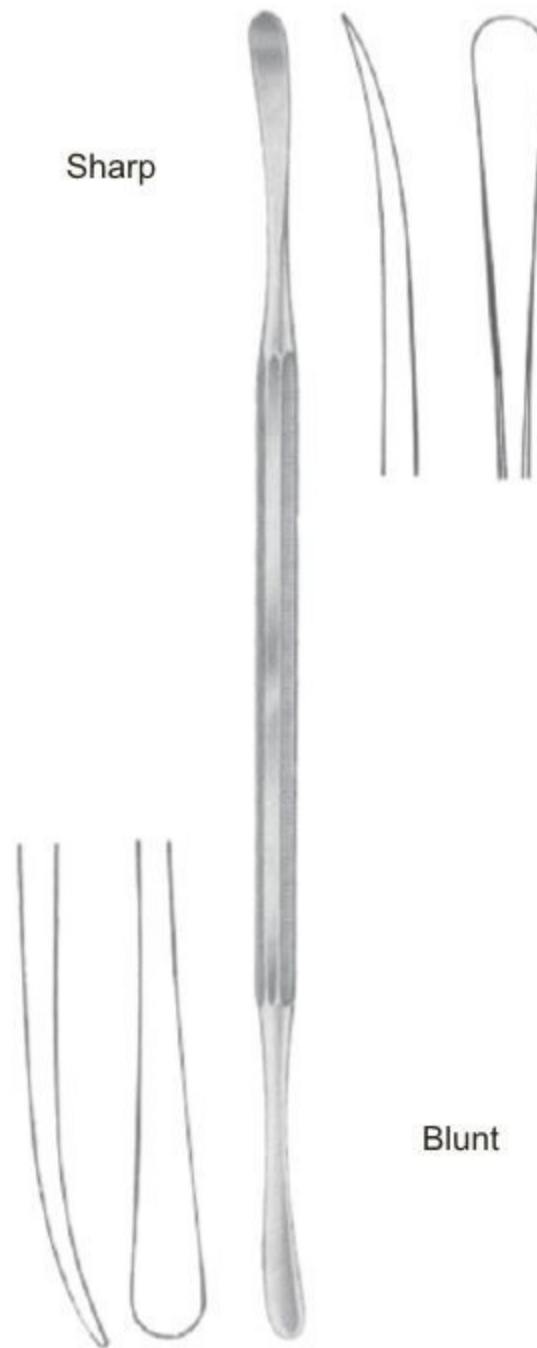

Sharp

Blunt

15-4351-22
 22 cm/8¼"



Woodsen
 15-4352-25
 25 cm/10"



Frager
 15-4353-20
 20 cm/8"



Frager
 15-4354-20
 20 cm/8"



Sachs
 15-4355-21
 21 cm/8¼"



Milligan
 15-4356-21 21 cm/8¼"



Olivecrona
 15-4357-18 18 cm/7"
 15-4357-24 24 cm/9½"



Olivecrona
 15-4358-19 19.5 cm/7¾"
 15-4358-24 24 cm/9½"



Horsley
 15-4359-20 20 cm/8"



Sachs
 15-4360-21 21 cm/8¼"

Brain Spatulas, Malleable Spatulas ●— EN
 Hirnspatel, Temperguss Spatel ●— DE
 Espátulas cerebrales, Espátulas maleable ●— ES



Cushing
 17 cm/6¾"
 20 cm/8"
 28 cm/11"

15-4361-17
 15-4361-20
 15-4361-28

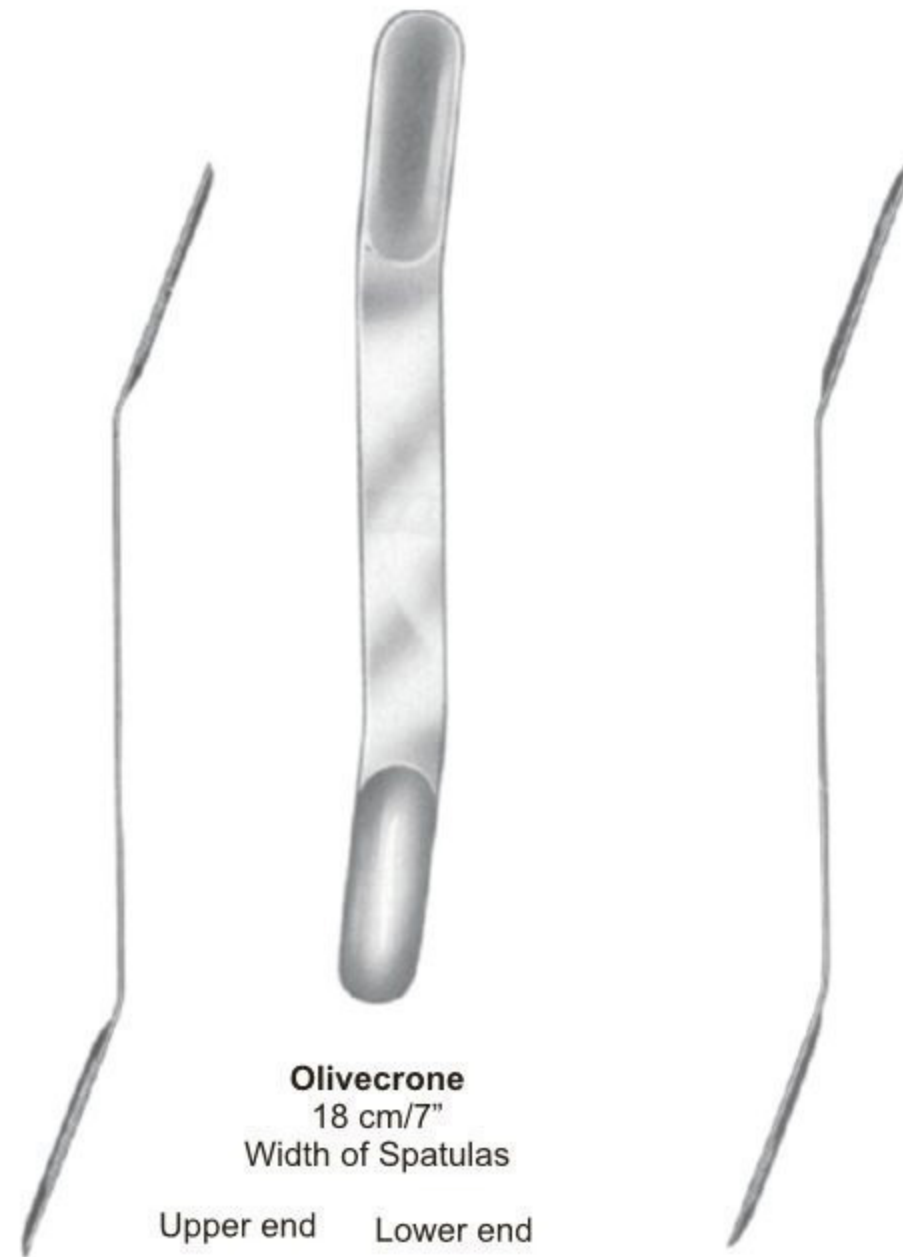

Olivecrona
 18 cm/7"
 Width of Spatulas

	Upper end	Lower end	
Concave	mm	mm	Convex
15-4362-01	7	9	15-4363-01
15-4362-02	11	13	15-4363-02
15-4362-03	15	18	15-4363-03
15-4362-04	18	22	15-4363-04



Heifetz
 20 cm/8"

Width of Spatulas

Upper end		Lower end
mm		mm
7	15-4364-08	8
10	15-4364-11	11
13	15-4364-13	14
16	15-4364-17	17
19	15-4364-20	20
22	15-4364-25	22



Heifetz
 15.5 cm/6"

Width of Spatulas

15-4365-08	8
15-4365-11	11
15-4365-13	14
15-4365-17	17

Length of Spatulas



18 cm/7"

Width of spatulas

Upper end	Lower end	
mm	mm	
7	9	15-4366-09
11	13	15-4366-13
15	18	15-4366-18
18	22	15-4366-22



20 cm/8"
 12 mm 15-4367-12
 17 mm 15-4367-17



20 cm/8"
 14 mm 15-4368-14
 17 mm 15-4368-17
 20 mm 15-4368-20



15-4369-01
 19cm/7½"



Love
 15-4370-02
 19 cm/7½"



15-4371-03



Love
 15-4372-21
 21 cm/8¼"

Nerve Root Retractors ● EN
 Nervwurzelhaken ● DE
 Separadores de raíz de nervios ● ES

Length of spatulas



70 mm
 3 mm 15-4373-03

100 mm
 15-4374-03



5 mm 15-4373-05

15-4374-05



7 mm 15-4373-07

15-4374-07



Love



Scoville
 23 cm/9"

7 mm 15-4375-07
 9 mm 15-4375-09



Holsher
 7mm 15-4376-07
 9mm 15-4376-09
 24 cm/9½"



8 mm 15-4377-08
 13 mm 15-4377-13



Taylor
 30x 70 mm 15-4378-07 17 cm/6¾"
 30x100 mm 15-4378-10 17 cm/6¾"



Oldberg
 21 cm/8¼"



15-4379-01



15-4379-02



15-4379-03



15-4379-04

Nerve Root Retractors ● EN
 Nervwurzelhaken ● DE
 Separadores de raíz de nervios ● ES



Cushing
 15-4380-19 19 cm/7 $\frac{3}{4}$ "
 15-4380-28 28 cm/11"



Smithwick
 15-4381-17 17 cm/6 $\frac{1}{2}$ "
 15-4381-21 21 cm/8 $\frac{1}{4}$ "



Cushnig
 15-4382-14
 14 cm/5 $\frac{1}{2}$ "



Adson
 20 cm/8"



15-4383-01



15-4383-02



Cloward
 15-4384-16
 16 cm/6 1/2"



Hoen
 15-4385-22
 22 cm/8 3/4"



Dandy
 15-4386-01
 20 cm/8"



Dandy
 15-4387-02
 20 cm/8"



Dandy
 15-4388-03
 20 cm/8"



Smithwick
 15-4389-29
 29 cm/11 3/4"



Scoville
 15-4390-30
 30 cm/12"



Scoville
 15-4391-30
 30 cm/12"

Nerve Retractors and Knives ● EN
 Nerve Retraktoren und Messer ● DE
 Retractores del nervio y Cuchillos ● ES



Graham
 15-4392-16
 16.5 cm/6½"



Toennis
 15-4393-15
 15 cm/6"



Frazier
 15-4394-13 13 cm/5"
 15-4394-18 18 cm/7"



Toennis
 15-4395-13 13 cm/5"
 15-4395-18 18 cm/7"



Olivecrona
 15-4396-23
 23 cm/9"



Olivecrona
 15-4397-20
 20.5 cm/8"



Ferris-Smith-Kerrison

		Width of Bite	Length of Shaft		
			15 cm/6"	20 cm/8"	18 cm/7"
Cutting Upward		0.6 mm			15-4404-00
		1 mm			15-4404-01
		2 mm			15-4404-02
		3 mm	15-4398-03	15-4401-03	15-4404-03
		4 mm			15-4404-04
		5 mm	15-4398-05	15-4401-05	15-4404-05
Cutting Upward 40°		0.6 mm			15-4405-00
		1 mm			15-4405-01
		2 mm			15-4405-02
		3 mm	15-4399-03	15-4402-03	15-4405-03
		4 mm			15-4405-04
		5 mm	15-4399-05	15-4402-05	15-4405-05
Cutting Downwards		0.6 mm			15-4406-00
		1 mm			15-4406-01
		2 mm			15-4406-02
		3 mm	15-4400-03	15-4403-03	15-4406-03
		4 mm			15-4406-04
		5 mm	15-4400-05	15-4403-05	15-4406-05



Ferris-Smith-Kerrison



		Width of Bite		Length of Shaft		
Cutting Upward			15 cm/6"	20 cm/8"	18 cm/7"	
		3 mm	15-4407-03	15-4410-03	15-4413-03	
		5 mm	15-4407-05	15-4410-05	15-4413-05	
Cutting Upward 40°		3 mm	15-4408-03	15-4411-03		
		5 mm	15-4408-05	15-4411-05		
Cutting Downward		3 mm	15-4409-03	15-4412-03		
		5 mm	15-4409-05	15-4412-05		
				15-4414-03		
				15-4414-05		



Love-Kerrison

		Width of Bite		Length of Shaft		
		2 mm	3 mm	15 cm/6"	20 cm/8"	18 cm/7"
Cutting Upward		2 mm				15-4419-02
		3 mm	15-4415-03	15-4417-03		15-4419-03
		4 mm	15-4415-04	15-4417-04		15-4419-04
		5 mm	15-4415-05	15-4417-05		15-4419-05
		6 mm				15-4419-06
Cutting Upward 40°		2 mm				15-4420-02
		3 mm				15-4420-03
		4 mm				15-4420-04
		5 mm				15-4420-05
		6 mm				15-4420-06
Cutting Downward		2 mm				15-4421-02
		3 mm	15-4416-03	15-4418-03		15-4421-03
		4 mm	15-4416-04	15-4418-04		15-4421-04
		5 mm	15-4416-05	15-4418-05		15-4421-05
		6 mm				15-4421-06
Cutting Upward 40°		2 mm				15-4422-02
		3 mm				15-4422-03
		4 mm				15-4422-04
		5 mm				15-4422-05
		6 mm				15-4422-06



		Width of Bite	Length of Shaft	
Cutting Upward		3 mm	15 cm/6"	20 cm/8"
		5 mm	15-4423-03	15-4426-03
Cutting Upward 40°		3 mm	15-4424-03	15-4427-03
		5 mm	15-4424-05	15-4427-05
Cutting Downward		3 mm	15-4425-03	15-4428-03
		5 mm	15-4425-05	15-4428-05



	Length Of Shaft			
Cushing 2 x 10 cm	5"/13 cm	15-4429-01	15-4430-02	15-4431-03
	6"/15 cm	15-4429-01	15-4430-02	15-4431-03
	7"/18 cm	15-4429-01	15-4430-02	15-4431-03
Love-Grunwald 3 x 10 cm	5"/13 cm	15-4429-01	15-4430-02	15-4431-03
	6"/15 cm	15-4429-01	15-4430-02	15-4431-03
	7"/18 cm	15-4429-01	15-4430-02	15-4431-03
Spurling 4 x 10 cm	5"/13 cm	15-4429-01	15-4430-02	15-4431-03
	6"/15 cm	15-4429-01	15-4430-02	15-4431-03
	7"/18 cm	15-4429-01	15-4430-02	15-4431-03



With Suction/Irrigation Device

	Length Of Shaft			
Cushing 2 x 10 cm	5"/13 cm	15-4432-01	15-4433-02	15-4434-03
	6"/15 cm	15-4432-01	15-4433-02	15-4434-03
	7"/18 cm	15-4432-01	15-4433-02	15-4434-03
Love-Grunwald 3 x 10 cm	5"/13 cm	15-4432-01	15-4433-02	15-4434-03
	6"/15 cm	15-4432-01	15-4433-02	15-4434-03
	7"/18 cm	15-4432-01	15-4433-02	15-4434-03
Spurling 4 x 10 cm	5"/13 cm	15-4432-01	15-4433-02	15-4434-03
	6"/15 cm	15-4432-01	15-4433-02	15-4434-03
	7"/18 cm	15-4432-01	15-4433-02	15-4434-03



Ferris-Smith

Width Of Jaw



2 x 10 mm	15-4435-01	15-4436-02	15-4437-03
3 x 10 mm	15-4435-01	15-4436-02	15-4437-03
4 x 10 mm	15-4435-01	15-4436-02	15-4437-03

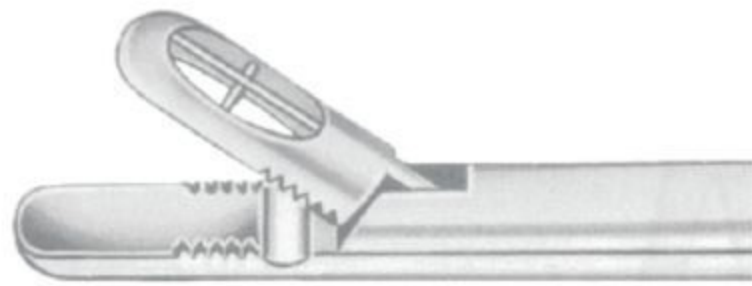

Serrated and Fenestrated Jaws

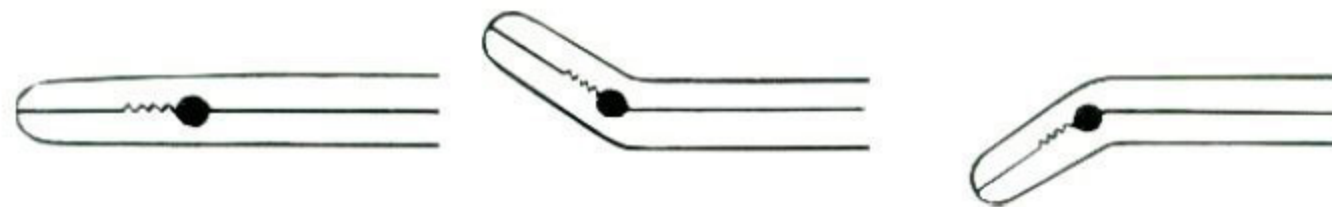

Width Of Jaw	Length Of Shaft			
mm	14 cm/5 1/2"	15-4438-01	15-4438-02	15-4438-03
	16 cm/6 1/4"	15-4439-01	15-4439-02	15-4439-03
2 x 12	14 cm/5 1/2"	15-4440-01	15-4440-02	15-4440-03
	16 cm/6 1/4"	15-4441-01	15-4441-02	15-4441-03
3 x 12	14 cm/5 1/2"	15-4442-01	15-4442-02	15-4442-03
	16 cm/6 1/4"	15-4443-01	15-4443-02	15-4443-03
4 x 14	14 cm/5 1/2"	15-4444-01	15-4444-02	15-4444-03
	16 cm/6 1/4"	15-4445-01	15-4445-02	15-4445-03
5 x 14	14 cm/5 1/2"	15-4446-01	15-4446-02	15-4446-03
	16 cm/6 1/4"	15-4447-01	15-4447-02	15-4447-03
6 x 16	14 cm/5 1/2"			
	16 cm/6 1/4"			



Ø 3.5 mm

Yasargil
 15-4448-35
 19.5 cm/7¾"



Ø 6.5 mm

Oldberg
 15-4449-65
 18 cm/7"



Ø 9 mm

Landolt
 15-4450-90
 21 cm/8¼"

Tumor Grasping Forceps Blunt

Laminectomy Rongeurs ● EN
 Laminektomie-Zangen ● DE
 Pinzas cortantes para laminectomía ● ES



Weil-Blakesley



15-4451-01



15-4451-02



15-4451-03



15-4451-04



15-4451-05



15-4452-01



15-4452-02



15-4452-03



15-4452-04



15-4452-05



15-4453-01



15-4453-02



15-4453-03



15-4453-04



15-4453-05



15-4454-01



15-4454-02



15-4454-03



15-4454-04





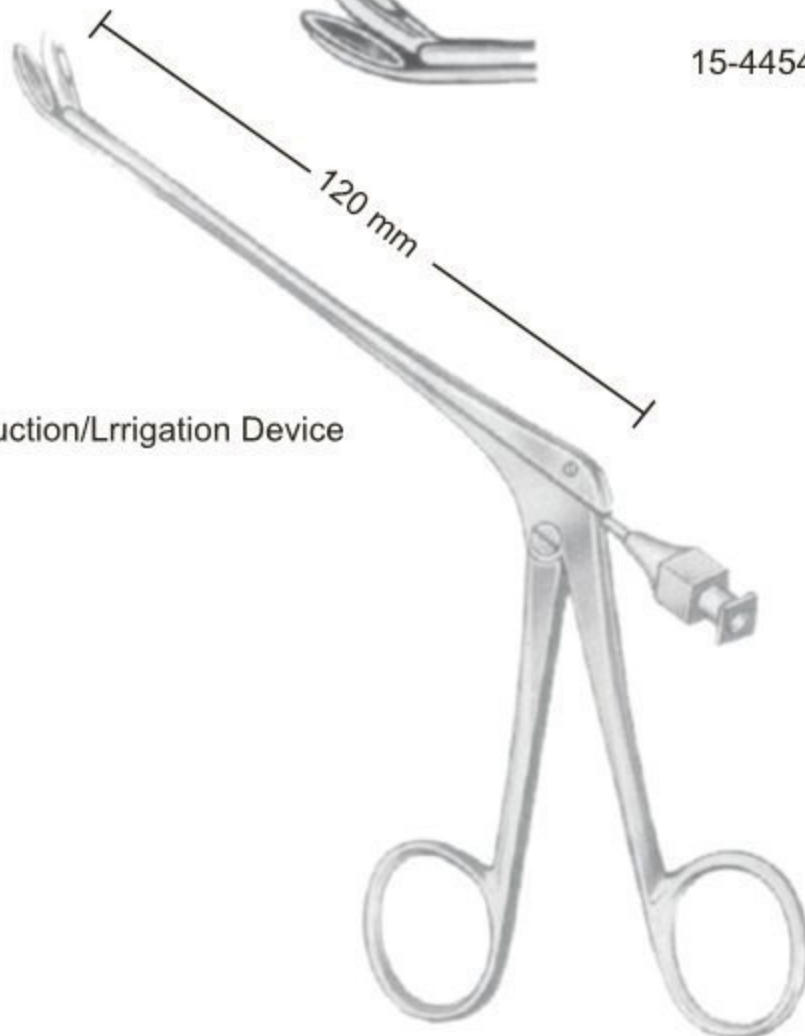

15-4454-05

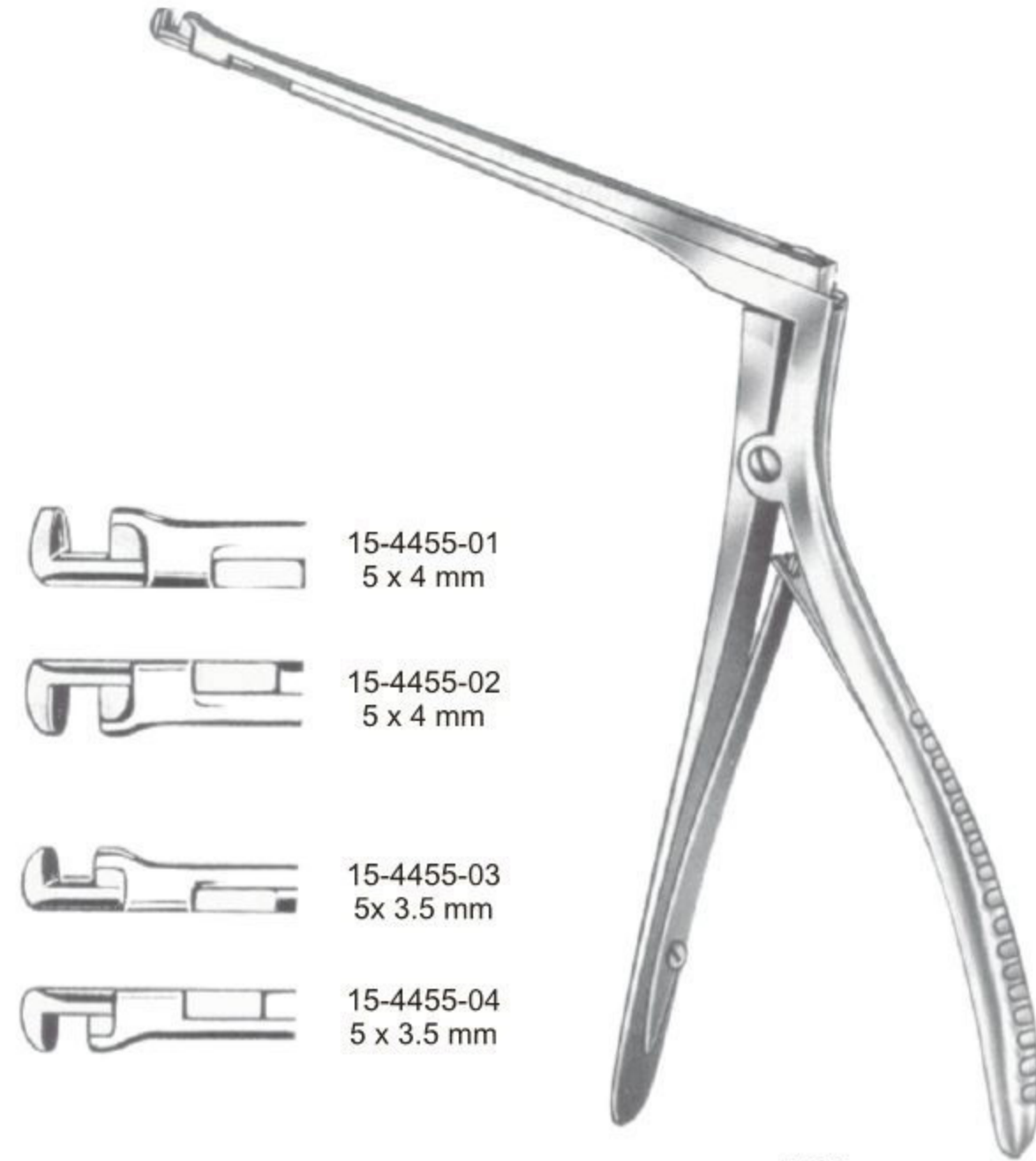

With Suction/Irrigation Device

Weil-Blakesley



-  15-4455-01
5 x 4 mm
-  15-4455-02
5 x 4 mm
-  15-4455-03
5 x 3.5 mm
-  15-4455-04
5 x 3.5 mm

**Hajek
 (Hajek-Kofler)**
 14 cm/5½"

360° Turnable

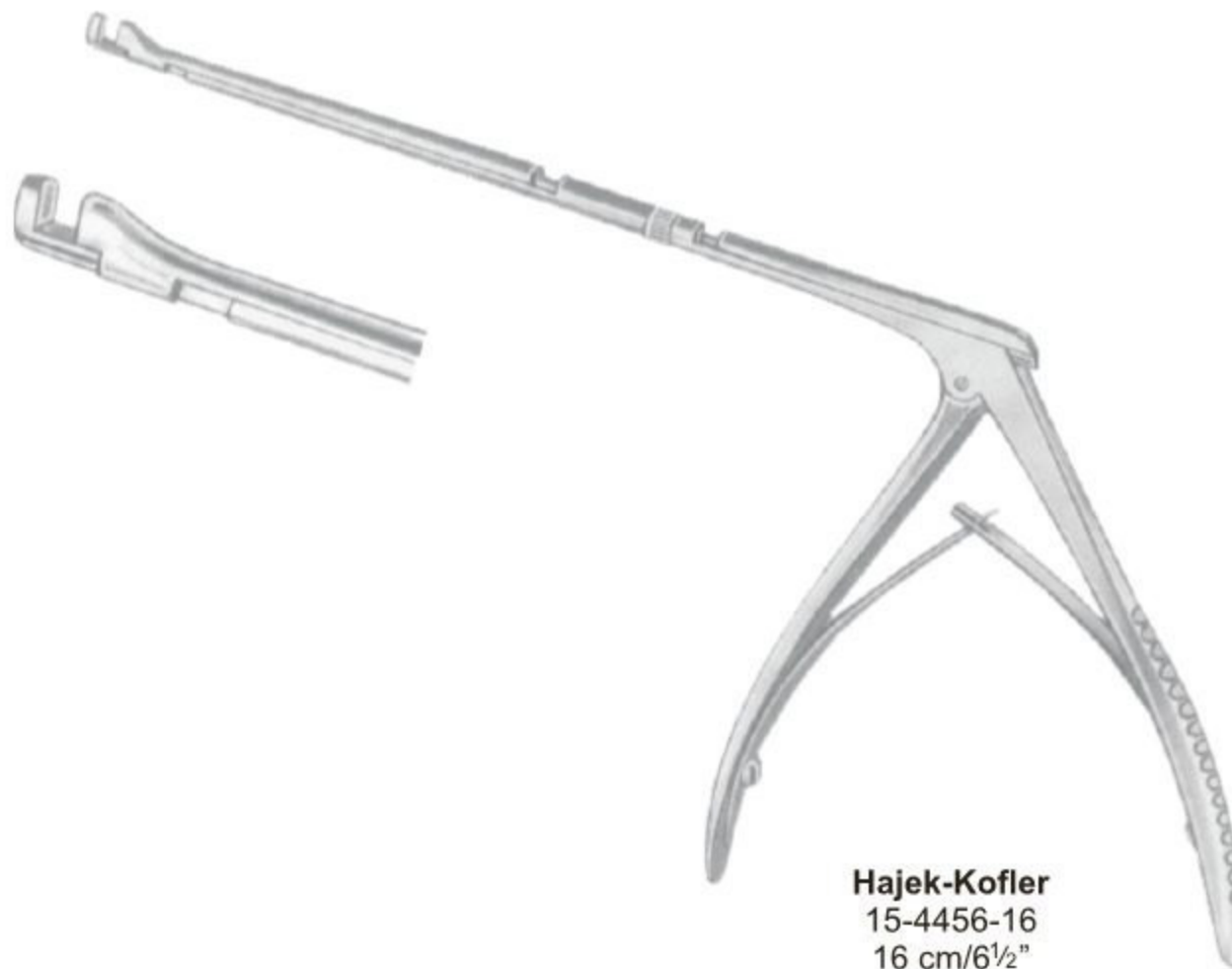

Hajek-Kofler
 15-4456-16
 16 cm/6½"

- EN** Ophthalmology
- DE** Ophthalmologie
- ES** Oftalmología

Page 389 to 419



- EN —● Eye Speculas
- DE —● Lidsperrer
- ES —● Espéculos ojo



Weiss
 Children 16-4501-07
 7 cm/2¾"
 Adults 16-4502-09
 9 cm/3½"



Weiss
 Children 16-4503-07
 7 cm/2¾"
 Adults 16-4504-09
 9 cm/3½"



Park
 16-4505-08
 8 cm/3¼"



Park-Guyton
 16-4506-08
 8 cm/3¼"



Park-Maumenee
 16-4507-08
 8 cm/3¼"



Barraquer (Colibri)
 Children 16-4508-03
 3 cm/1¼"
 Adults 16-4509-04
 4 cm/1½"



Barraquer
 16-4510-04
 4 cm/1½"



Bowman
 16-4511-07
 7 cm/2¾"



Sauer
 16-4512-03
 3 cm/1¼"



Goldstein
 16-4513-03
 3 cm/1¼"



Pley
 16-4514-06
 6 cm/2¼"

For left eye



Arruga
 16-4515-07
 7 cm/2¾"

For right eye



Arruga
 16-4516-07
 7 cm/2¾"

Eye Speculas ● EN
 Lidsperrer ● DE
 Espéculos ojo ● ES



Mellinger-Axenfeld
 16-4517-07
 7 cm/2 3/4"



Mellinger-Axenfeld
 16-4518-07
 7 cm/2 3/4"

Children
 16-4519-05
 5 cm/2 3/4"



Mellinger
 Adults
 16-4520-07
 7 cm/2 3/4"



Children
 16-4521-05
 5 cm/2"

Mellinger Beard
 Adults
 16-4522-07
 7 cm/2 3/4"



Knapp Clark
 16-4523-08
 8 cm/3 1/4"



Children
 16-4524-06
 6 cm/2 1/2"

Graefe
 Adults
 16-4525-09
 9 cm/3 1/2"



Lancaster
 16-4526-08
 8 cm/3 1/4"



Children
 16-4527-07
 7 cm/2 3/4"

Williams
 Adults
 16-4528-08
 8 cm/3 1/4"



Lister-Burch
 16-4529-08
 8 cm/3 1/4"



Weiss
 16-4530-08
 8 cm/3 1/4"



Murdock
 16-4531-05
 5 cm/2"



Mueller
 16-4532-07
 7 cm/2 3/4"



Critchett
 16-4533-06
 6 cm/2 1/2"



Castroviejo
 16-4534-08
 8 cm/3 1/4"



Schepens
 16-4535-13
 13 cm/5"



Desmarres
 16-4536-13
 13 cm/5"



8 mm

Conway
 16-4537-13
 13 cm/5"



Desmarres
 13 cm/5"



16-4538-12
 12 mm



16-4538-14
 14 mm



16-4538-16
 16 mm



16-4538-18
 18 mm

Lid plate



Jaeger
 16-4539-11
 11 cm/4½"

Eye Knives ●— EN
 Eye Messer ●— DE
 Cuchillos ojo ●— ES

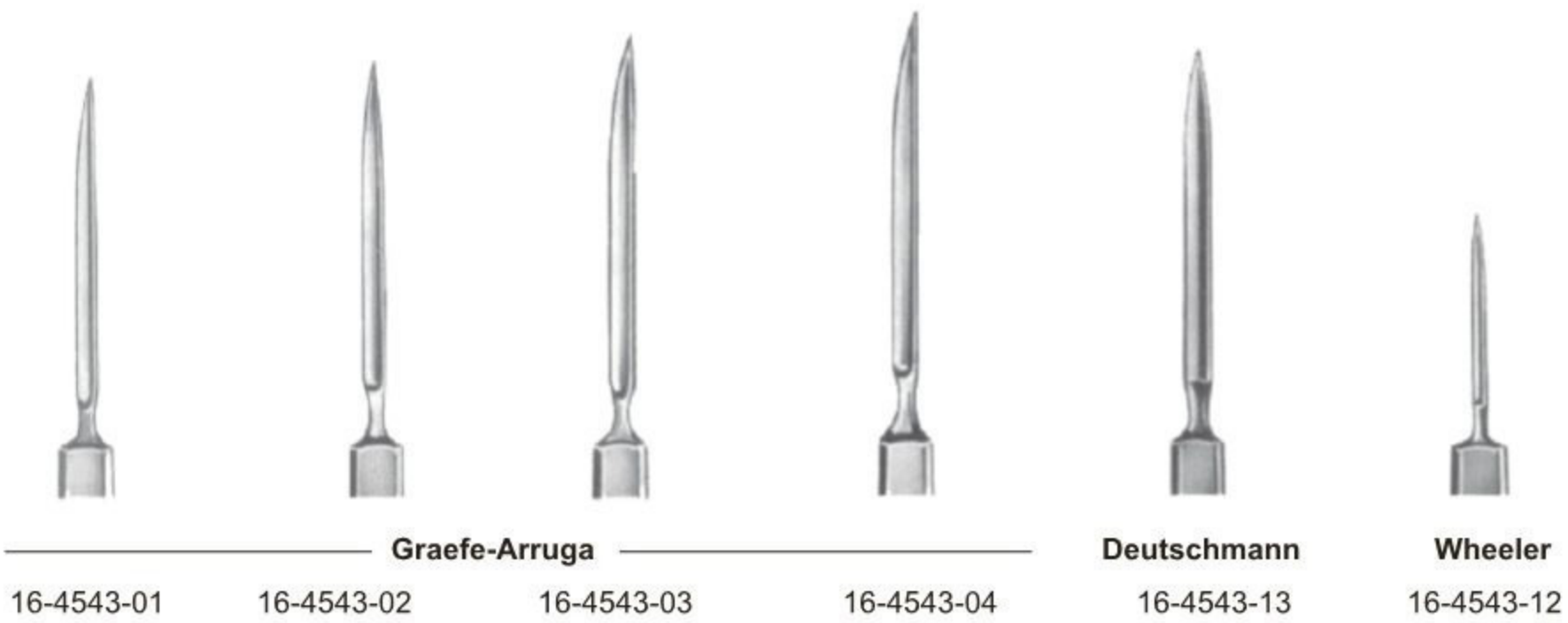
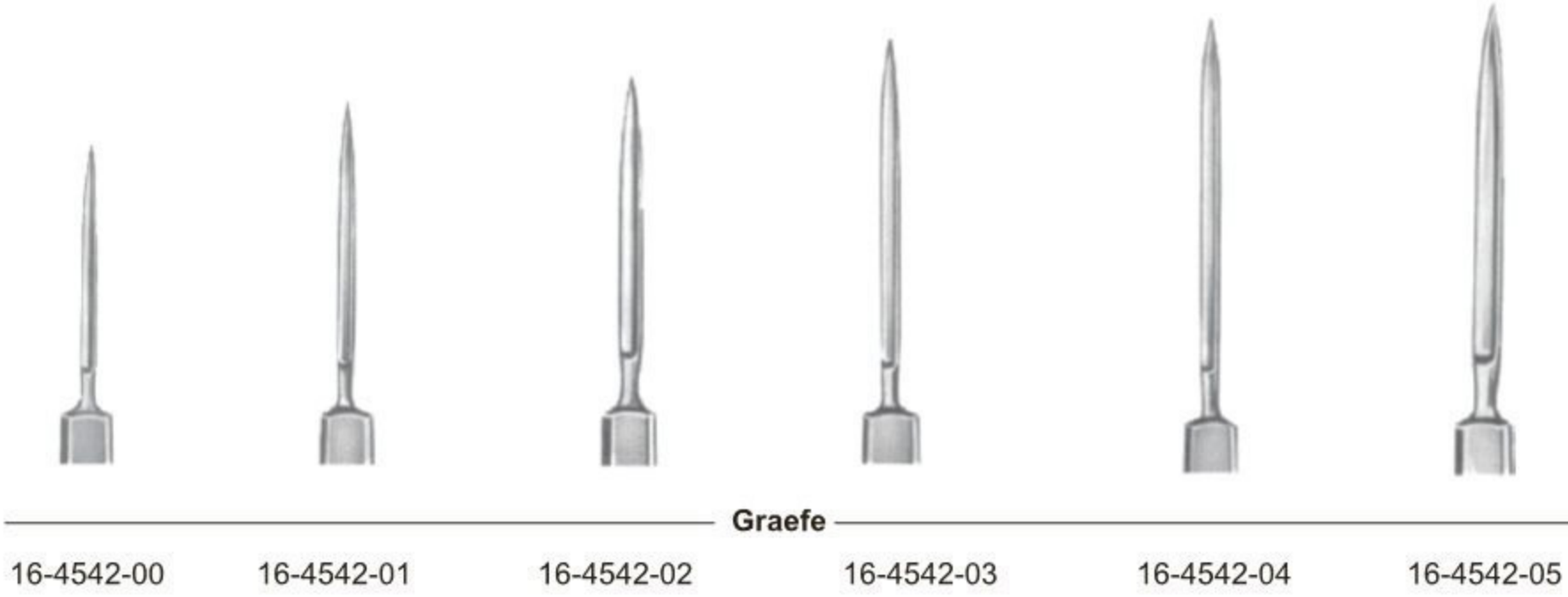
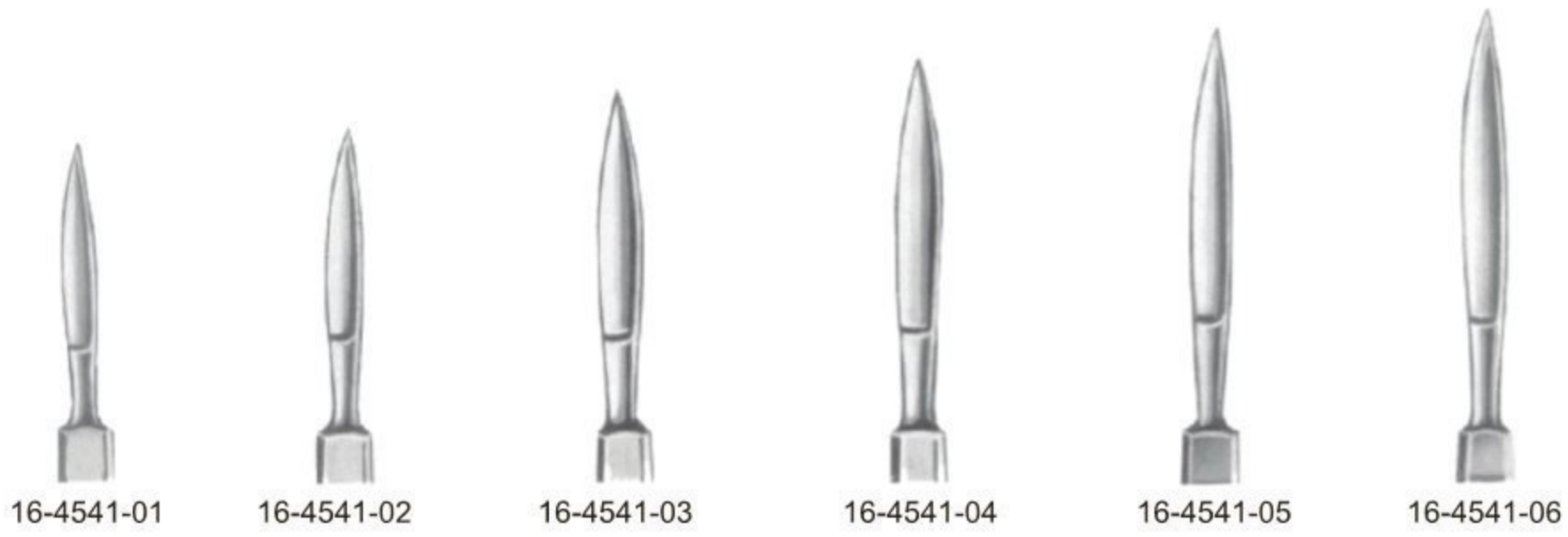



Jaeger
 16-4544-01



16-4544-02



16-4544-03



16-4544-04



16-4545-01



16-4545-02



16-4545-03



16-4545-04



16-4546-01



16-4546-02



16-4546-03



16-4546-04



16-4547-01



16-4547-02



16-4547-03



16-4547-04

Jaeger-Grieshaber



16-4548-01



16-4548-02



16-4548-03



16-4548-04

Jaeger-Grieshaber

Keratomes, Various Eye Knives ●— EN
 Keratomes, Verschiedene Eye Messer ●— DE
 Keratomes, varios cuchillos de ojos ●— ES

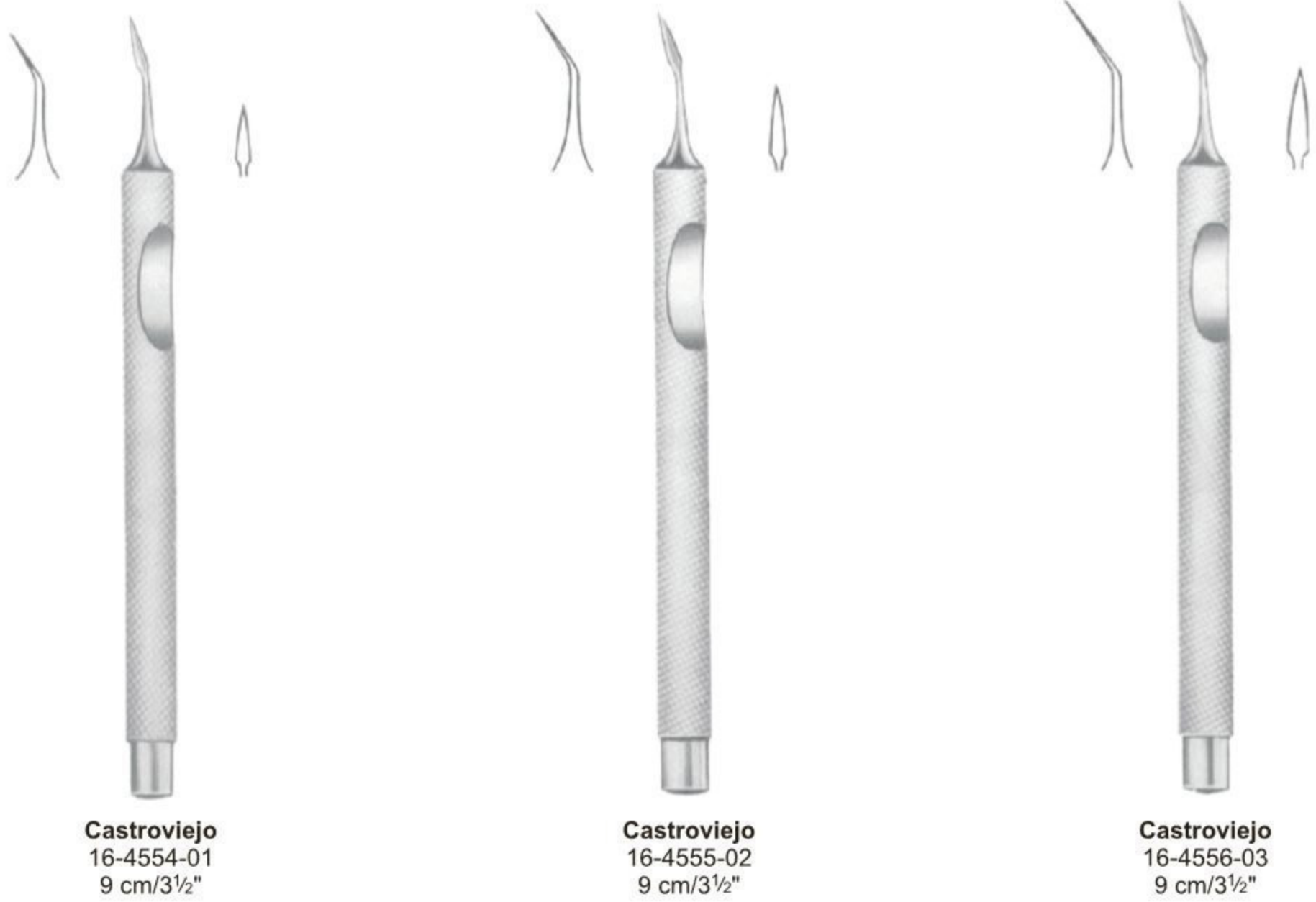



Mod. Hamburg
 16-4557-12



Graefe
 16-4558-13



16-4559-01



Weber
 16-4559-02



16-4559-03



Bowman
 16-4560-04
 0.4 mm



Bowman
 16-4560-05
 0.5 mm



Bowman
 16-4560-06
 0.6 mm



Bowman
 16-4560-07
 0.7 mm



Bowman
 16-4560-08
 0.8 mm



Left **Bowman** Right
 16-4561-01 16-4561-02



16-4562-01



Knapp
 16-4562-02



16-4562-03



16-4563-05
 5 mm



Ziegler
 16-4563-06
 6 mm



16-4563-07
 7 mm

Various Eye Knives ● EN
 Verschiedene Eye Messer ● DE
 Varios cuchillos de ojos ● ES



Dean
16-4564-13



Zigler
16-4565-11
3½ mm



Sato
16-4566-12



Sichel
16-4567-13



Graefe
16-4568-13



Graefe
16-4569-13



16-4570-01



Kuhnt
16-4571-02



16-4572-03



16-4573-04



Paton
16-4574-12



Elsching
16-4575-13



Took
16-4576-12



16-4577-01



Desmarres
16-4578-02



16-4579-03



Gill
16-4580-12



Guthrie
16-4581-12



Guthrie
16-4582-13



Berens
16-4583-12



Knapp
Blunt
16-4584-13



Rollet
Sharp
16-4585-12



Rollet
16-4586-12



Fink
Blunt
16-4587-12



Right
16-4588-01

Left
16-4588-02

10.5 cm/4 1/4"



Knapp-Rollet
16-4589-02



Flexible
16-4589-03



16-4589-04



- EN —● Enucleation Scoops and Chalazion Curettes
- DE —● Enucleation Schaufeln und Chalazion Küretten
- ES —● Enucleación Scoops y curetas Chalazión

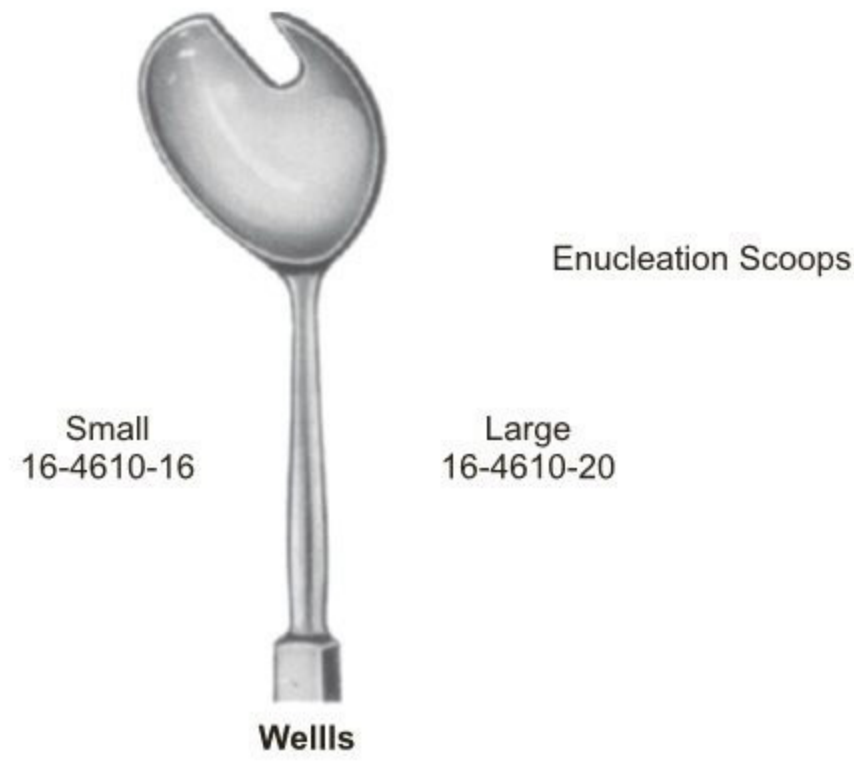

Chalazion Curettes



Exenteration Scoops and Chalazion Curettes Lachrymal Sac Dissectors ● EN

Exenteration Schaufeln und Chalazion Küretten Tränensack Dissektoren ● DE

Exenteración Scoops y Chalazión Curetas saco lagrimal Disectores ● ES

Exenteration Scoops

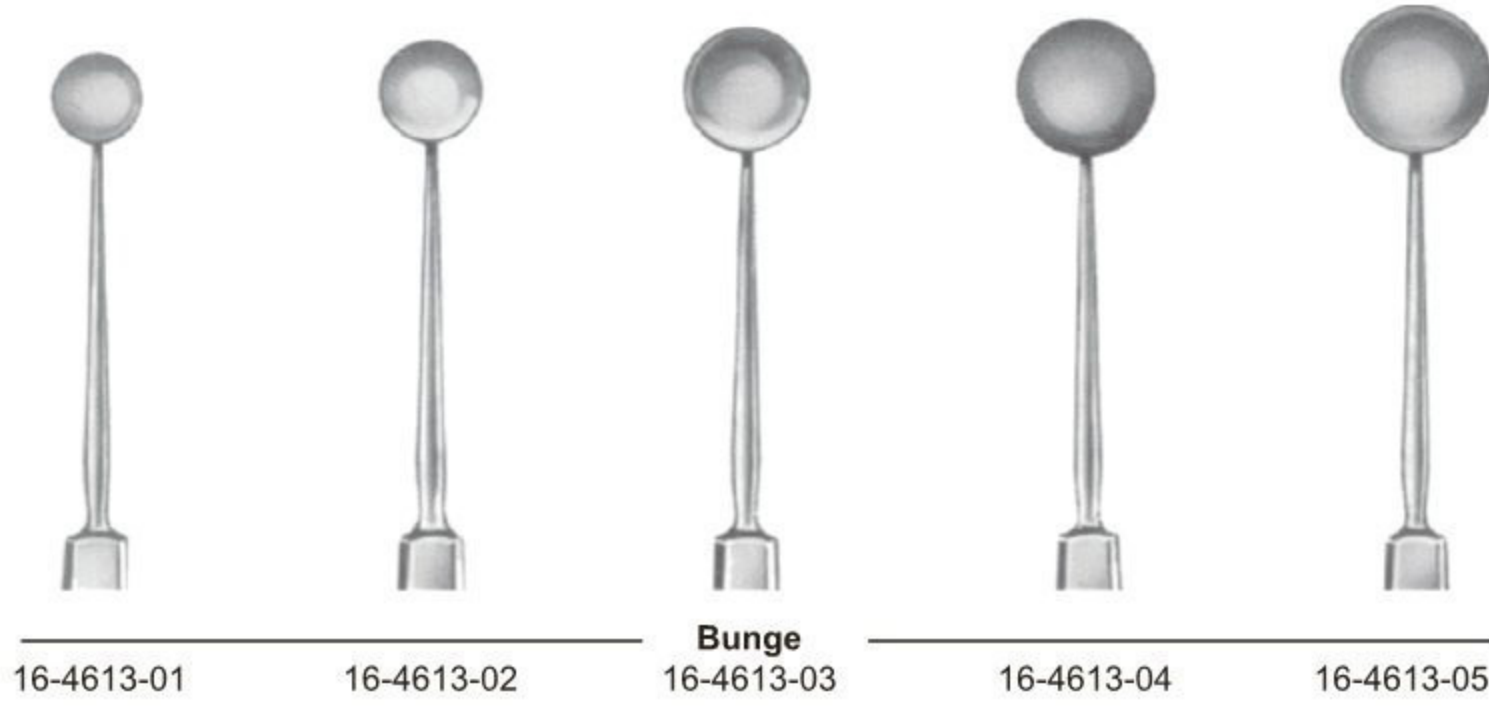

Chalazion Curette, Double

Axenfeld
16-4614-13
13 cm/5"



Lachrymal Sac Dissector

Lang
16-4615-13
13 cm/5"

Irrigating Cannulas

Straight



Binkhorst
 16-4616-01
 22 gauge

Right



Binkhorst
 16-4617-02
 22 gauge

Left



Binkhorst
 16-4618-03
 22 gauge



Bonn
 16-4619-04
 20 gauge



Bonn
 16-4620-05
 19 gauge

Probe Point



Hamburg
 16-4621-06
 23 gauge

Irrigation/Aspiration Cannulas



Simcoe
 16-4622-01
 23 gauge



stotome Cannulas

Gills-Welsh
 16-4623-02
 25/23 gauge

Lens Manipulation Cannulas



Knolle-Kelmann
 16-4624-01
 22 gauge



Nevyas
 16-4625-02
 22 gauge



Kratz
 16-4626-03
 22 gauge



Freeman
 16-4627-01
 27 gauge

Eye Cannulas ●— EN
 Augenkanülen ●— DE
 Cánulas ojo ●— ES



Sheets
 16-4628-01

Irrigating Vectis Cannulas



Knolle Pearce
 16-4629-02



Simcoe
 16-4630-03

Cortex Aspiration Cannulas



Simcoe
 16-4631-01
 23 gauge



Simcoe
 16-4632-02
 23 gauge

Capsule Polishing Cannulas



Kratz
 16-4633-01



Simcoe
 16-4634-02

Posterior



Jensen
 16-4635-03

- EN —● Calipers, Markers, Punches Chisels, Marking instruments and Lachrymal Dilators
- DE —● Messschieber, Marker, Punches Meißel, Kennzeichnung Instrumente und Lachrymal Dilatoren
- ES —● Pinzas, marcadores, cinceles Punzones, los instrumentos de marcado y Dilatadores lagrimales



Castroviejo
16-4636-15



Castroviejo
16-4637-20
20 mm



Holth
16-4638-01



Haitz
16-4639-02



West
16-4640-16
16 cm/6 1/4"



West
16-4641-16
16 cm/6 1/4"



Connin-Amsler
16-4642-13
13 cm/5"



Wilder
16-4643-01



Wilder
16-4644-02



Wilder
16-4645-03

Lachrymal Dilators and Probes ● EN
 Lachrymal Dilatoren und Probes ● DE
 Dilatadores lagrimales y sondas ● ES



16-4646-13 16-4647-13

Needle Only
 16-4648-01

Chisel Only
 16-4648-02

Gouge Only
 16-4648-03



16-4649-13

Instrumentation for D. B. Kirby Operations



16-4650-10



Teeth
 16-4651-10 1:2 Teeth
 16-4652-10 2:3 Teeth



16-4653-10
 1 : 2



Kirby
 16-4654-10
 10 cm/4"



Kirby
 16-4655-10
 10 cm/4"



16-4656-10



16-4657-10



Tuebingen
 16-4658-10
 10 cm/4"



16-4659-08
 8.5 cm/3 1/2"



Paufigue
 16-4660-10
 10 cm/4"



Barraquer
 16-4661-10
 10.5 cm/4 1/4"



McPherson
 16-4662-10
 10 cm/4"



McPherson
 16-4663-07
 7.5 cm/3"

Suture Forceps, Strabismus Forceps ●— EN
 Suture Pinzetten, Zangen Strabismus ●— DE
 Sutura Pinzas, estrabismo ●— ES



McCullough
 16-4664-09
 9.5 cm/3 3/4"



McCullough
 16-4665-09
 9.5 cm/3 3/4"



Bonaccoito
 16-4666-10
 10 cm/4"



Bonaccoito
 16-4667-10
 10 cm/4"



16-4668-11
 11 cm/4 1/2"



11 cm/4 1/2"

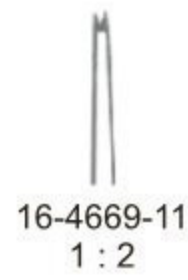

16-4669-11
 1 : 2

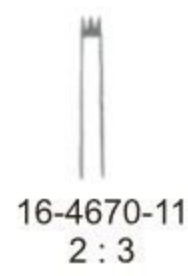

16-4670-11
 2 : 3



Nugent
 10 cm/4"



16-4671-01



16-4672-02

EN —● Strabismus, Muscle and Advancement Forceps

DE —● Strabismus, Muskel-und Advancement Zange

ES —● Estrabismo, los músculos y Promoción Pinzas

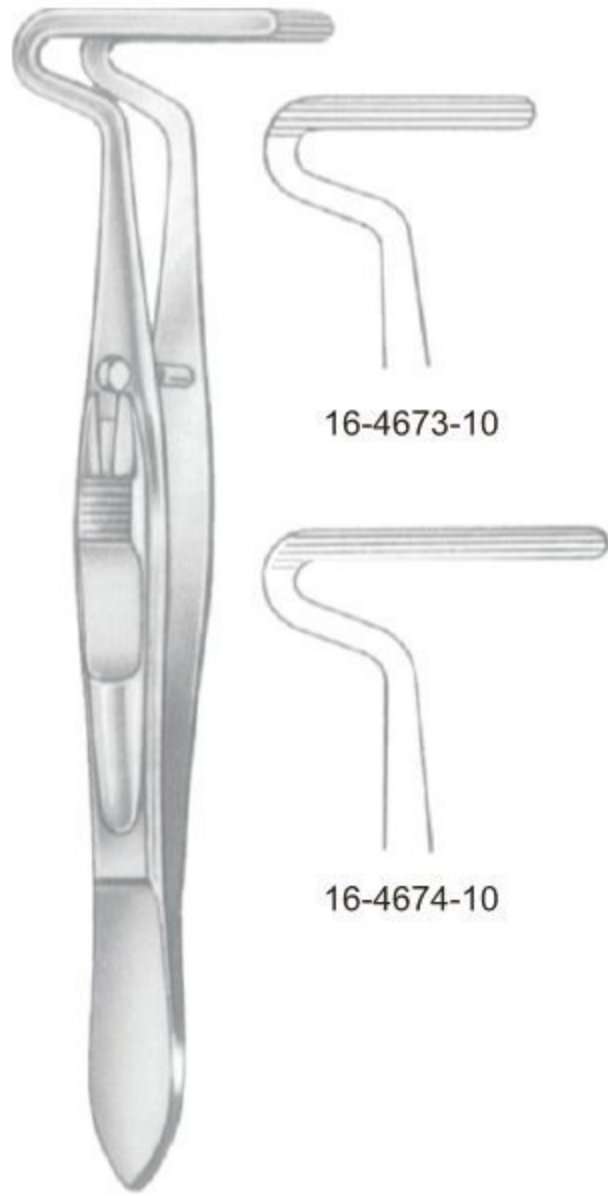

Berke
10 cm/4"



Blascovics
16-4675-09
9 cm/3 1/2"



Blascovics
16-4676-09
9 cm/3 1/2"



Worth
16-4677-10
10 cm/4"



Worth
16-4678-10
10 cm/4"



Jameson
16-4679-10
10 cm/4"



Jameson
16-4680-10
10 cm/4"



Prince
16-4681-10
10 cm/4"



Prince
16-4682-10
10 cm/4"

Entropium, Anterior Chamber Forceps ● EN
 Entropium, Vorderkammer Zange ● DE
 Entropion, pinzas Cámara Anterior ● ES



Snellen
 16-4683-10
 10 cm/4"



Snellen
 16-4684-10
 10 cm/4"



Erhardt
 16-4685-09
 9 cm/3 1/2"

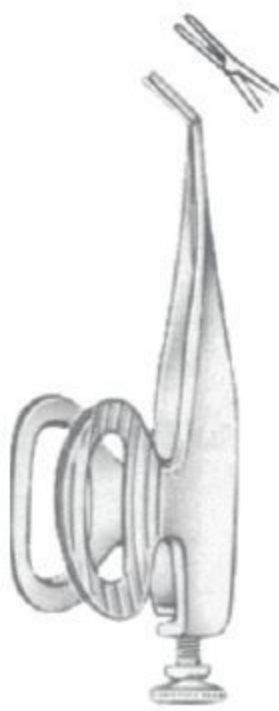

Barraquer
 16-4686-05
 5.5 cm/2 1/4"



Barraquer
 16-4687-07
 5.5 cm/2 1/4"



Barraquer
 16-4688-10
 5.5 cm/2 1/4"



Iris Forceps ● EN

Iris Zange ● DE

Iris Pinzas ● ES



Graefe
10 cm/4"



16-4696-10



16-4697-10



16-4698-10



16-4699-10



16-4700-10



16-4701-10

Conjunctival forceps



Stevens
10.5 cm/4¼"



16-4702-10



16-4703-10



16-4704-10



O'Connor
16-4708-10
10 cm/4"



16-4705-10



16-4706-10



16-4707-10



Stevens
16-4709-11
11 cm/4½"



Stevens
16-4710-11
11 cm/4½"



Fischer
 16-4711-07
 7 cm/2 3/4"



Fischer-Arit
 16-4712-07
 7 cm/2 3/4"



Hess
 16-4713-07
 7 cm/2 3/4"



Hess
 16-4714-07
 7 cm/2 3/4"



Smooth **Chandler** Serrated
 16-4715-01 7 cm/2 3/4" 16-4716-02



Fuchs
 16-4717-07
 7 cm/2 3/4"



Gill-Hess
 16-4718-07
 7.5 cm/3"



Gill-Hess Teeth Below
 16-4719-07 7.5 cm/3"
 Teeth on side 16-4720-07



Barraquer-Katzin
 (Colibri)
 16-4721-07
 7 cm/2 3/4"

Capsular Forceps ● EN
 Kapsel-Pinzetten ● DE
 capsular Pinzas ● ES



Fuchs
 16-4722-07
 7 cm/2 ¾"



Kalt
 16-4723-10
 10 cm/4"



Terson
 16-4724-09
 9.5 cm/3 ¾"



Arruga-Nizetic
 16-4725-10
 10 cm/4"



Castroviejo
 16-4726-10
 10 cm/4"



Castroviejo
 16-4727-10
 10 cm/4"



Elschnig
 16-4728-10
 10 cm/4"

For Len Implantation



Binkhorst
 16-4729-07
 7 cm/2 ¾"



Arruga
 16-4730-09
 9.5 cm/3 ¾"



Arruga
 16-4731-09
 9.5 cm/3 ¾"



Knapp
 16-4732-11
 11 cm/4¼"



Ayer
 16-4733-09
 9 cm/3½"



Ayer
 16-4734-09
 9 cm/3½"



Lambert
 16-4735-09
 9 cm/3½"



Desmarres
 16-4736-01
 9 cm/3½"



16-4736-01



16-4737-02



16-4738-03

Iridectomy Scissors ●— EN
 Iridektomie Scissors ●— DE
 Tijeras iridectomía ●— ES



Fig. 1



Fig. 2

Fig. 3

Noyes
 Fig.1 16-4739-01
 Fig.2 16-4739-02
 Fig.3 16-4739-03
 12 cm/4 ¾"



Noyes
 16-4740-12
 12 cm/4 ¾"



Wecker
 11.5 cm/4 ½"



16-4741-01



16-4742-02



Barraquer
 16-4743-05
 5.5 cm/2 ¼"



16-4744-09
 9 cm/3 ½"



16-4745-09



16-4746-09



16-4747-09



16-4748-09



16-4749-09



Straight

Vannas
 16-4750-08
 8 cm/3 1/4"



Curved

Vannas
 16-4751-08
 8 cm/3 1/4"

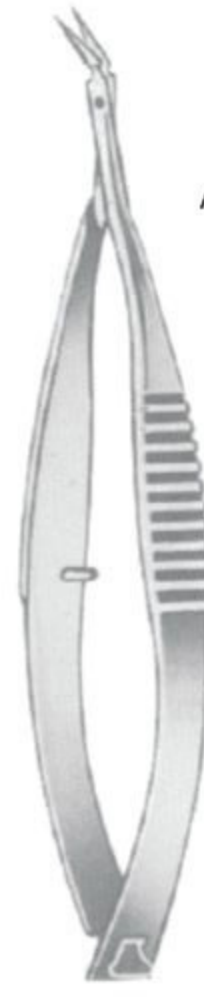

Angular

Vannas
 16-4752-08
 8 cm/3 1/4"

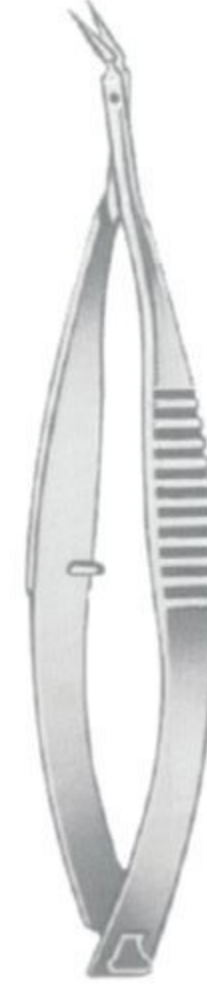

Vannas
 16-4753-08
 8 cm/3 1/4"



Straight

16-4754-08
 8.5 cm/3 1/4"



Curved

16-4755-08
 8.5 cm/3 1/4"



Angular

16-4756-08
 8.5 cm/3 1/4"



Angular

16-4757-08
 8.5 cm/3 1/4"

Vannas Mod, Tubingen

- Iridectomy Scissors ●— EN
- Iridektomie Scissors ●— DE
- Tijeras iridectomía ●— ES



16-4758-10
10 cm/4"



16-4759-10
10 cm/4"



Castroviejo
16-4760-10
10 cm/4"



Castroviejo
16-4761-10
10 cm/4"



Aebli
16-4762-10
10 cm/4"

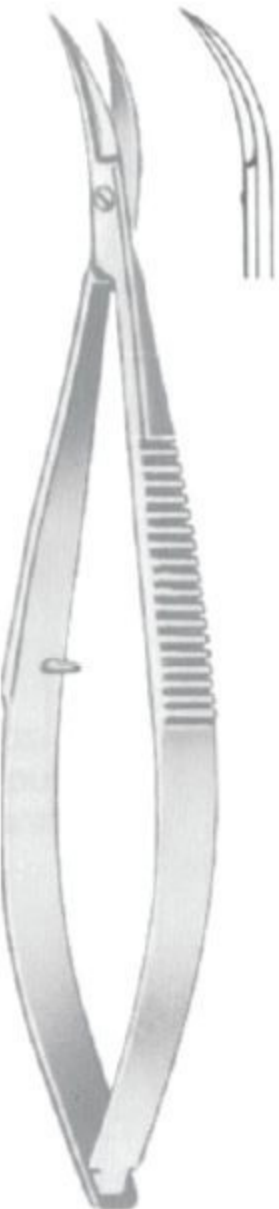

Castroviejo
16-4763-10
10 cm/4"



Castroviejo
16-4764-10
10 cm/4"

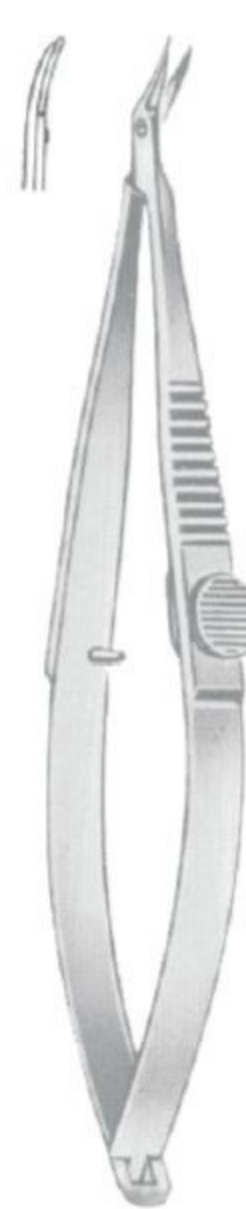

Troutman-Barraquer
16-4765-10
10 cm/4"

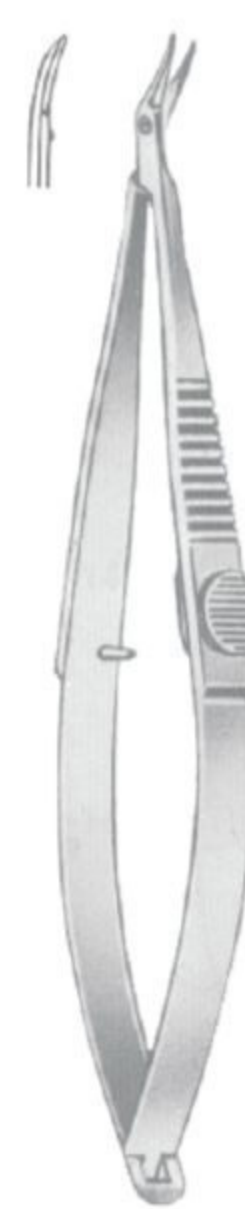

Troutman-Barraquer
16-4766-10
10 cm/4"



Saw Edge

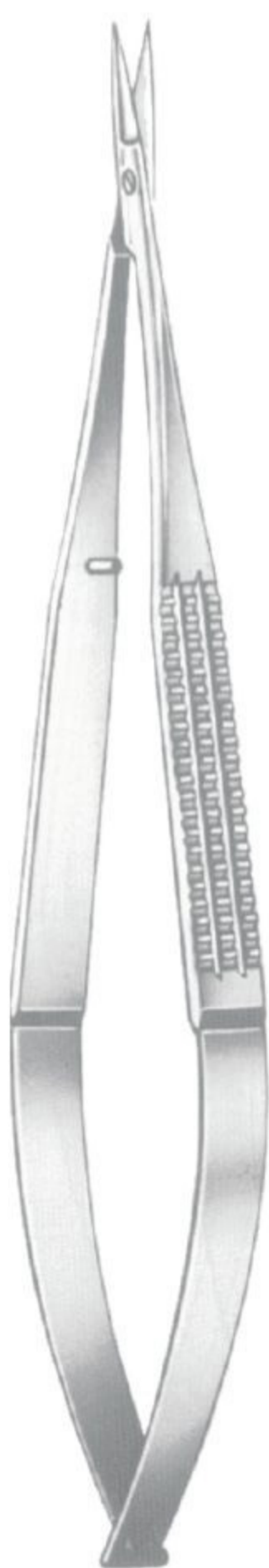

Straight
 16-4767-16
 16cm/6 1/4"

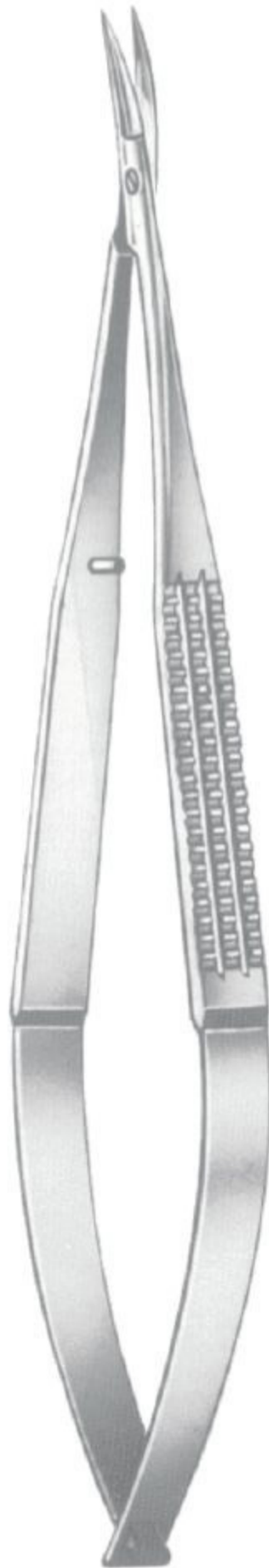

Curved
 16-4768-16
 16cm/6 1/4"

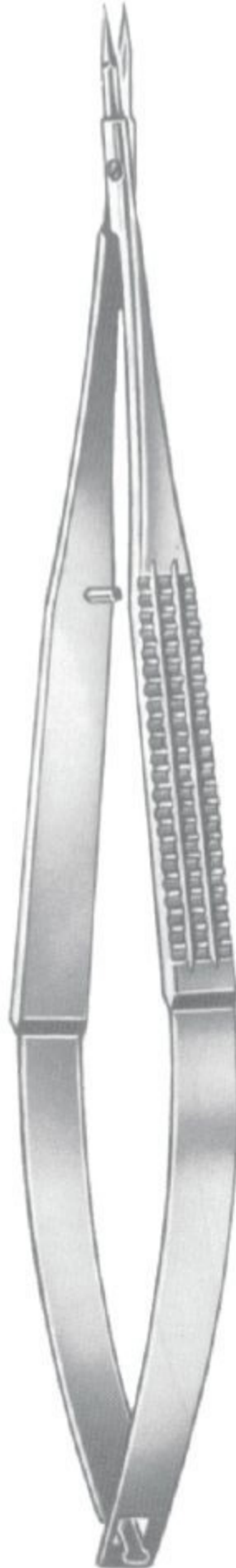

Straight
 16-4769-16
 16cm/6 1/4"

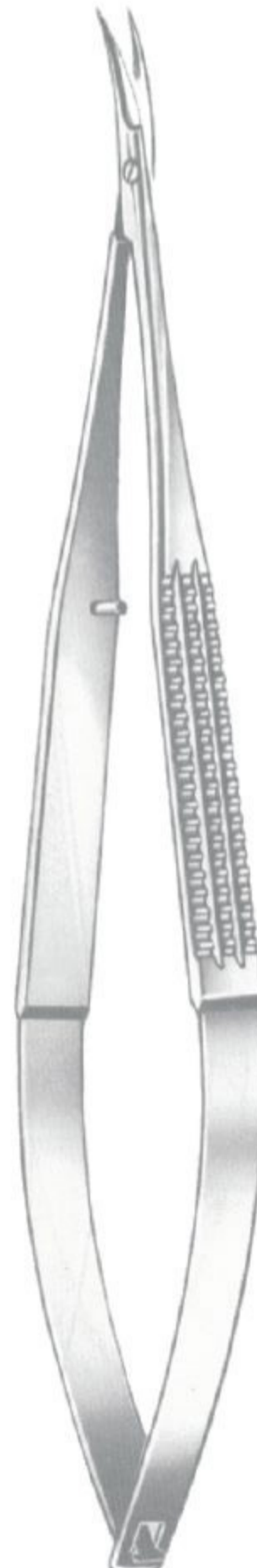

Curved
 16-4770-16
 16cm/6 1/4"



Millesi
 Straight
 16-4771-16
 16cm/6 1/4"



Millesi
 Curved
 16-4772-16
 16cm/6 1/4"

- Micro Scissors ● EN
- Mikro-Scheren ● DE
- Micro-Tijeras ● ES



Straight
 16-4773-18
 18.5cm/7 1/4"



Curved
 16-4774-18
 18.5cm/7 1/4"



Angular
 16-4775-18
 18.5cm/7 1/4"



Straight
 16-4776-23
 23cm/9"

Dissecting Scissors



Straight
 16-4777-14
 14.5cm/5 3/4"



Curved
 16-4778-14
 14.5cm/5 3/4"



Curved
 16-4779-14
 14.5cm/5 3/4"

EN Otology
DE Otologie
ES Otología

Page 420 to 437



Ø=Inside Dia



Troltsch
For Babies

- 17-4801-01 1.5 mm Ø
- 17-4801-02 2.5 mm Ø
- 17-4801-03 3.5 mm Ø

17-4801-30
Set of 3



Troltsch
For Adults

- 17-4802-04 4.0 mm Ø
- 17-4802-05 5.0 mm Ø
- 17-4802-06 6.0 mm Ø
- 17-4802-07 7.0 mm Ø

17-4802-30 17-4802-40
Set of 3 Set of 4



Politzer

- 17-4803-01 2.0 mm Ø
- 17-4803-02 3.0 mm Ø
- 17-4803-03 4.0 mm Ø

17-4803-30
Set of 3



Erhard
For Adults

- 17-4804-01 3.0 mm Ø
- 17-4804-02 4.0 mm Ø
- 17-4804-03 5.0 mm Ø
- 17-4804-04 6.0 mm Ø

17-4804-30 17-4804-40
Set of 3 Set of 4



Hartmann
For Babies

17-4805-01 2.0 mm Ø



Hartmann
For Children

- 17-4806-02 3.0 mm Ø
- 17-4806-03 4.0 mm Ø
- 17-4806-04 5.5 mm Ø

17-4806-30
Set of 3



Hartmann
For Adults

- 17-4807-03 4.0 mm Ø
- 17-4807-04 5.5 mm Ø
- 17-4807-05 6.5 mm Ø
- 17-4807-06 7.5 mm Ø

17-4807-30 17-4807-40
Set of 3 Set of 4



Toynbee
For Adults

- 17-4808-01 4.5 mm Ø
- 17-4808-02 5.5 mm Ø
- 17-4808-03 6.5 mm Ø
- 17-4808-04 7.5 mm Ø

17-4808-30 17-4808-40
Set of 3 Set of 4

Alu Black



17-4809-60
Set of 6

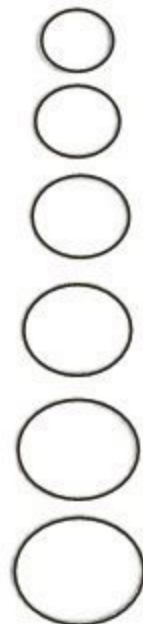

Ø=Inside Dia

- 17-4809-01 4.5 x 5.5 mm Ø
- 17-4809-02 5.5 x 6.5 mm Ø
- 17-4809-03 6.5 x 7.5 mm Ø
- 17-4809-04 7.5 x 8.5 mm Ø
- 17-4809-05 8.5 x 9.5 mm Ø
- 17-4809-06 9.5 x 10.5 mm Ø



Gruber

17-4810-30 17-4810-40 17-4811-40 17-4811-40
Set of 3 Set of 4 Set of 3 Set of 4



- 17-4810-01 3 mm Ø
- 17-4810-02 4 mm Ø
- 17-4810-03 5 mm Ø
- 17-4810-04 6 mm Ø



- 17-4811-01 3 mm Ø
- 17-4811-02 4 mm Ø
- 17-4811-03 5 mm Ø
- 17-4811-04 6 mm Ø

Ear Speculas ● EN
 Ohrspekula ● DE
 Espéculos auriculares ● ES



Hartmann
 17-4812-40
 Set of 4

- Black
- 17-4812-01 3.0 mm Ø
 - 17-4812-02 4.0 mm Ø
 - 17-4812-03 5.0 mm Ø
 - 17-4812-04 7.0 mm Ø



Hartmann
 17-4813-20
 Set of 2

- Black
- 17-4813-05 9.0 mm Ø
 - 17-4813-06 11.0 mm Ø



17-4814-01



17-4814-02
 17-4814-01 4.2 x 3.8 mm
 17-4814-02 5.5 x 3.8 mm
 17-4814-03 6.5 x 3.8 mm
 17-4814-30
 Set of 3



17-4814-03



17-4815-01



17-4815-02



17-4815-03

- 17-4815-01 4.2 mm
- 17-4815-02 5.5 mm
- 17-4815-03 6.5 mm
- 17-4815-30
 Set of 3

- 17-4816-03 3.5 mm Ø
- 17-4816-04 4.5 mm Ø
- 17-4816-05 5.5 mm Ø
- 17-4816-06 6.5 mm Ø

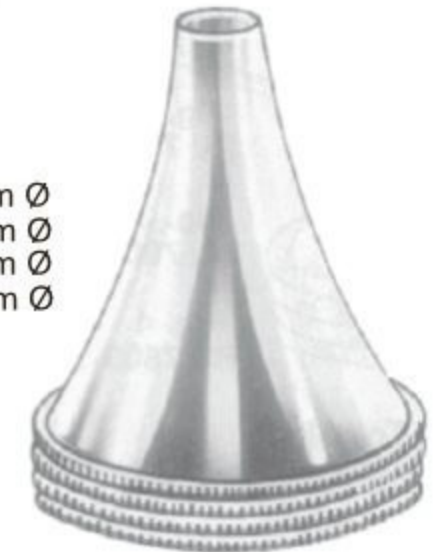

Boucheron
 17-4816-40
 Set of 4



Turmakin Speculum
 Black finish (slot)

A= Distal tip diameter
 B= Distal slot width
 C= Proximal slot width

- 17-4817-01 No. 1 A=3mm B=2.5mm C=4mm
- 17-4817-02 No. 2 A=4.5mm B=3mm C=5mm
- 17-4817-03 No. 3 A=6.5mm B=3mm C=5mm
- 17-4817-04 No. 4 A=7mm B=3mm C=5mm
- 17-4817-05 No. 5 A=7.5mm B=3.5mm C=7mm
- 17-4817-06 No. 6 A=8mm B=4mm C=8mm
- 17-4817-07 No. 7 A=8.5mm B=4.5mm C=9mm
- 17-4817-08 No. 8 A=9mm B=5mm C=10mm
- 17-4817-09 No. 9 A=11mm B=6mm C=11mm



Gruber Speculum
 Black finish (round)

- 17-4818-03 3mm
- 17-4818-04 4mm
- 17-4818-05 5mm
- 17-4818-06 6mm

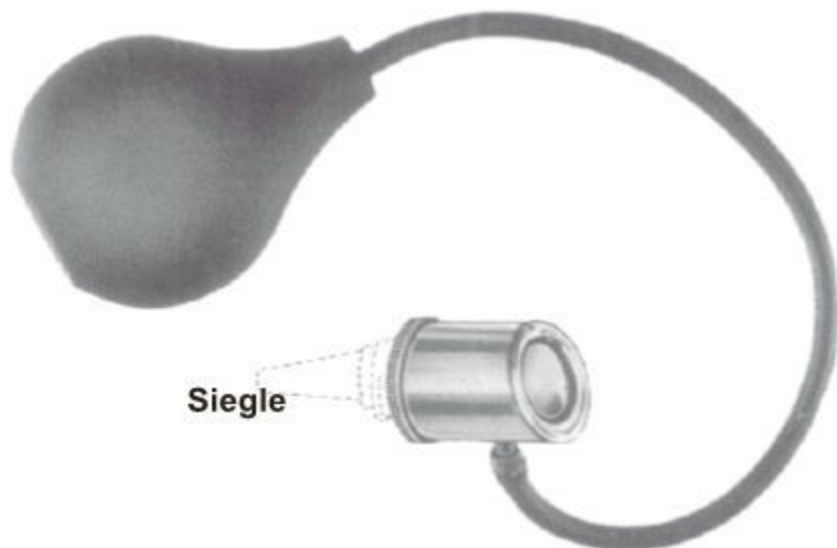

Siegle



Otoscope with 3 ear specula and rubber tube with bulb
 17-4819-00

Tuning Forks



Hartmann



Lucae



French Hartmann



Lucae
C 128



Hartmann
C 128



Rydel-Seiffer
17-4825-00
C 64/C 128

16			17-4822-16
32			17-4822-32
64			17-4822-01
128	17-4820-00	17-4821-00	17-4822-02
256	17-4820-01	17-4821-01	17-4822-03
512	17-4820-02	17-4821-02	
1024	17-4820-03	17-4821-03	
2048	17-4820-04	17-4821-04	
4096	17-4820-05	17-4821-05	

Variable up to h (Engl. B)
 17-4823-00 17-4824-00

With Clamps = C 64
 Without Clamps = C 128



Tuning Fork for neurological examination, with percussion hammer, pin wheel, brush and needle
 17-4826-00



17-4827-01
C 64



17-4827-02
C 128



17-4827-03
C 256



17-4827-04
C 512



17-4827-05
C 1024



17-4827-06
C 2048



17-4827-07
C 4096

Tuning Forks, Eustachian Catheters and Suction Instruments — EN

Tuning Forks, Eustachian Katheter und Sauginstrumente — DE

Diapasones, catéteres e instrumentos de succión Eustachin — ES

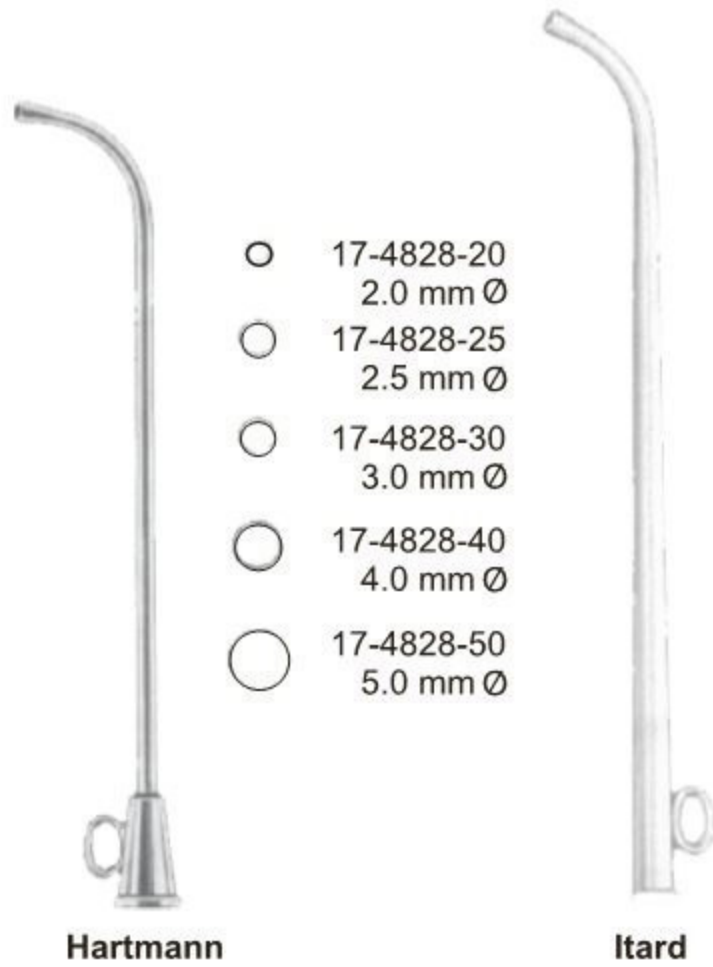

- 17-4828-20
2.0 mm Ø
- 17-4828-25
2.5 mm Ø
- 17-4828-30
3.0 mm Ø
- 17-4828-40
4.0 mm Ø
- 17-4828-50
5.0 mm Ø

Hartmann

Itard



- 17-4829-30
3 mm Ø
- 17-4829-35
3.5 mm Ø
- 17-4829-40
4 mm Ø
- 17-4829-45
4.5 mm Ø
- 17-4829-50
5 mm Ø

House

- 17-4830-09 0.9 mm Ø
- 17-4830-12 1.2 mm Ø
- 17-4830-15 1.5 mm Ø



Baron (Schuknecht)

- 17-4831-01 1.0 x 75 mm
- 17-4831-02 1.5 x 75 mm
- 17-4831-03 2.0 x 75 mm



Adson Frazier Suction Tube
with stilette
17-4832-02
2 x 180 mm
17-4832-03
3 x 180 mm



Schucknecht Suction Tube
with stilette
17-4833-18 swg 18
17-4833-20 swg 20
17-4833-22 swg 22
17-4833-24 swg 24



Zoellner Suction Tube
with stilette
length 150 mm
17-4834-15



Firth Suction Tube
rounded tip, with stilette
17-4835-70
70 x 80 mm
17-4835-80
80 x 90 mm



Lempert Suction Tube
with stilette
17-4836-06
Fig. 6, 2mm
17-4836-09
Fig. 9, 3mm
length 200 mm



Fraizer Suction Tube
with stilette
17-4837-02
Dia 2 mm
17-4837-03
Dia 3 mm
length 200 mm

- EN —● Ear Polypus Snares and Ear Dressing Forceps
- DE —● Polypenschnürer, Ohrpinzetten
- ES —● Polipótomos, Pinzas auriculares



Krause
 17-4838-16
 16 cm/6 1/4"



Krause-Voss
 17-4839-16
 16 cm/6 1/4"



Lange-Wilde
 17-4840-16
 16 cm/6 1/4"



Package of 1 dozen each

mm Ø	
17-4841-02	0.2
17-4841-03	0.3

Ear Dressing Forceps



**Troeltsch
 (Wilde)**



Troeltsch



Lucae



Lucae



Jansen

Cm	In	Troeltsch (Wilde)	Troeltsch	Lucae	Lucae	Jansen
11.0	4 1/4"	17-4842-11				
12.0	4 3/4"	17-4842-12	17-4843-12		17-4845-14	
14.0	5 1/2"	17-4842-14		17-4844-14		
15.0	6"	17-4842-15				
16.0	6 1/4"					17-4846-16
18.0	7"					17-4846-18
20.0	8"					17-4846-20

Ear Polypus Forceps and Foreign Body Levers ●— EN
 Polypenzängchen, Fremdkörperheber ●— DE
 Pinzas para pólipos, Elevadores para cuerpos extraños ●— ES



Okonogto
 17-4847-16
 16 cm/6¼"



Littauer
 17-4848-12
 12 cm/4¾"



Fine Pattern

Hartmann
 17-4849-12
 12 cm/4¾"



Hartmann
 17-4850-14
 14 cm/5½"



Standard Pattern

Tilley Aural Forcep
 17-4851-14 14cm/5 ½"
 17-4851-16 16cm/6 ¼"
 17-4851-18 18cm/7"



Buck
 17-4852-09
 9 cm/3½"



Quire
 17-4853-08
 8 cm/3¼"



Hartmann-Noyes
 17-4854-09
 8.5 cm/3 1/4"



1 : 2



Hartmann-Noyes
 17-4855-09
 8.5 cm/3 1/4"



Hartmann
 17-4856-09 8.5 cm/3 1/4"
 17-4856-14 14 cm/5 1/2"
 17-4856-16 16 cm/6 1/4"



1 : 2



Hartmann
 17-4857-09 8.5 cm/3 1/4"
 17-4857-14 14.0 cm/5 1/2"



Hartmann
 17-4858-20 8.5 cm/3 1/4" ○ 2.0 mm
 17-4858-25 8.5 cm/3 1/4" ○ 2.5 mm
 17-4858-30 8.5 cm/3 1/4" ○ 3.0 mm



Hartmann-Citelli
 17-4859-02 ○ 2 mm 8.5 cm/3 1/4"
 17-4859-03 ○ 3 mm 8.5 cm/3 1/4"



Strumpel
 17-4860-09
 8.5 cm/3 1/4"



Hartamm-Weingartner
 17-4861-09
 8.5 cm/3 1/4"



Hartamm
 17-4862-09
 8.5 cm/3 1/4"















Hartamm-Wullstein
 17-4863-06 8.5 cm/3 1/4" 08 x 6 mm
 17-4863-08 8.5 cm/3 1/4" 1.8 x 8 mm



Hartamm-Wullstein
 17-4864-01 ○ 1 mm 8.5 cm/3 1/4"
 17-4864-02 ○ 2 mm 8.5 cm/3 1/4"

Micro Ear Polypus Forceps ● EN
 Ohr-Polypenzangen ● DE
 Pinzas para pólipos auriculares ● ES



	Micro Forceps	Mini	Cup-Shaped Forceps
	1.6 x 7.0 mm  17-4865-01	0.7 x 3.5 mm  17-4866-08	0.9 x 1.1 mm  17-4867-11
	 17-4868-02 0.8 x 4.0 mm		
Smooth Jaw	 17-4869-03 0.8 x 6.0 mm		
Curved Left	 17-4870-04 0.8 x 6.0 mm		 17-4871-12 0.9 x 1.1 mm
Curved Right	 17-4872-05 0.8 x 4.0 mm		 17-4873-13 0.9 x 1.1 mm
Angled Up	 17-4874-06 0.8 x 4.0 mm		 17-4875-14 0.9 x 1.1 mm
Angled Down	 17-4876-07 0.8 x 4.0 mm		 17-4877-15 0.9 x 1.1 mm

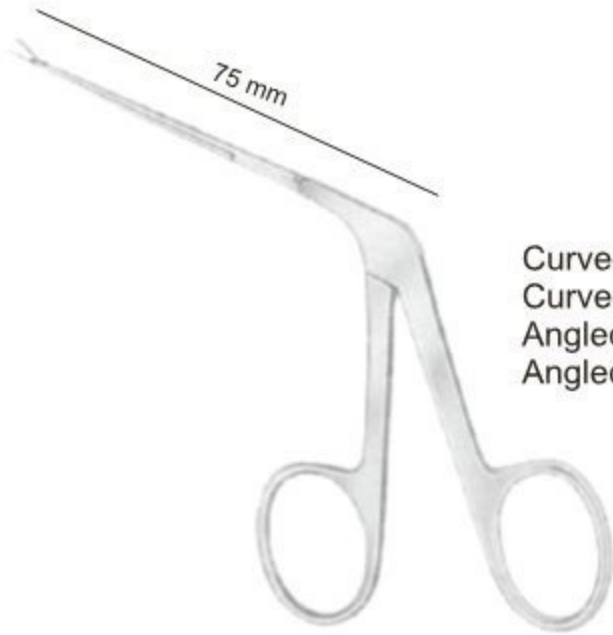

Curved Right 17-4878-01
 Curved Left 17-4878-02
 Angled Up 17-4878-03
 Angled Down 17-4878-04



Cup-Shaped Forceps

Micro Forceps 0.5 mm

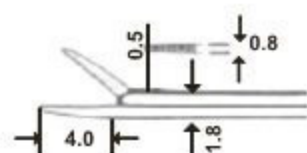

Straight 17-4879-01

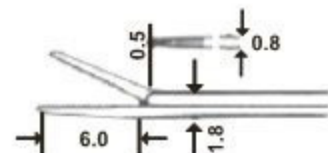

17-4879-02

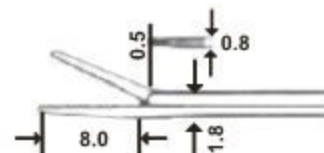

17-4879-03

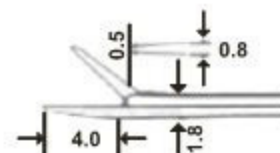

17-4879-04

Smooth Jaw 1.5 x 0.8 mm

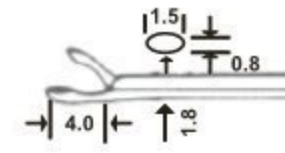

Straight 17-4883-01
 Curved Right 17-4883-02
 Curved Left 17-4883-03
 Angled Up 17-4883-04
 Angled Down 17-4883-05

Micro Forceps 0.3 mm

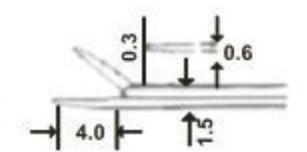

Straight 17-4880-01

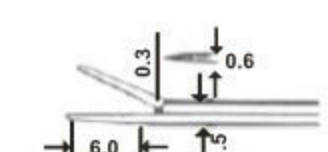

17-4881-02

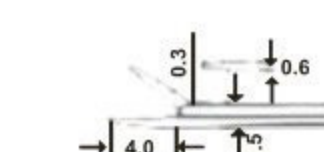

17-4882-03

Smooth Jaw

Smooth Jaw 1.0 x 0.5 mm

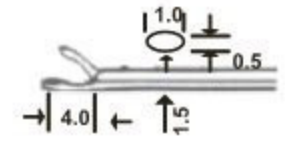

Straight 17-4883-06

Length of Shaft 8 cm

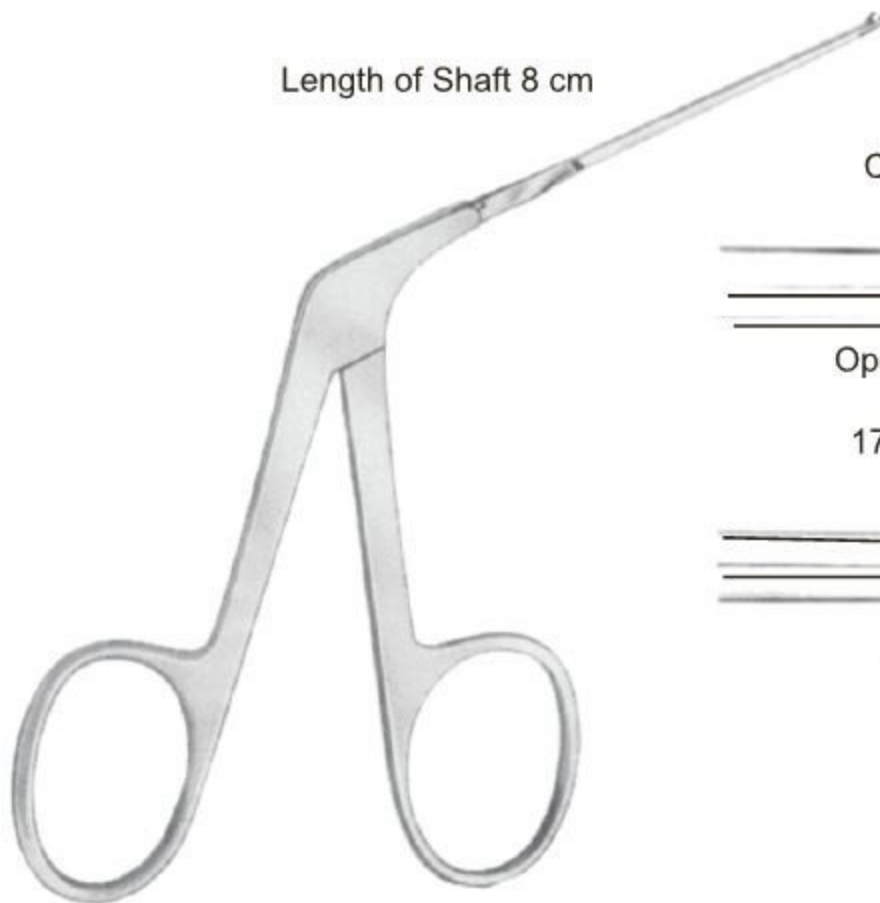

Crura Forceps

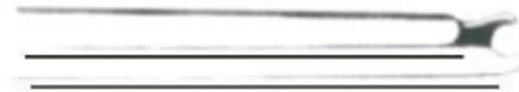

Open to Right
Fisch
 17-4885-01



Open to Left
Fisch
 17-4885-02

Micro Scissors

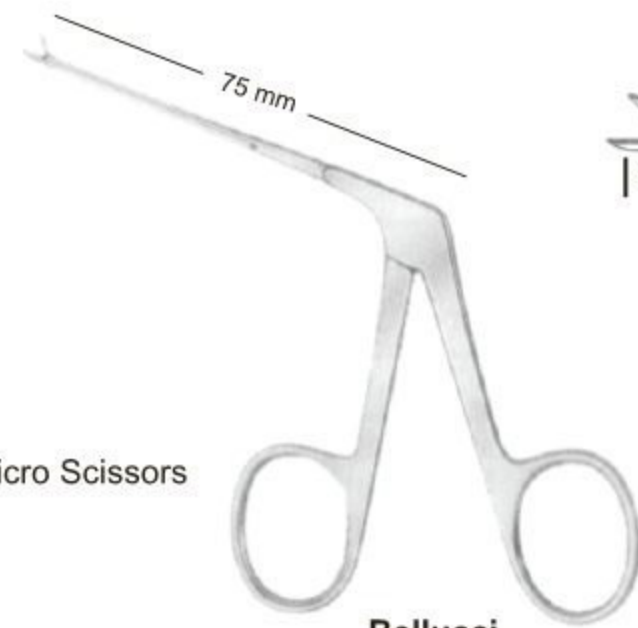

Bellucci
 0.8 mm

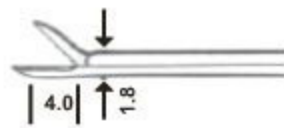

17-4884-01
 17-4884-02
 17-4884-03
 17-4884-04
 17-4884-05

Wire Closure Forceps

Length of Shaft 8 cm



Mc Gee
 17-4886-01



Mc Gee/Fisch
 17-4886-02



Henckel
 crocodile, scoop blades
 17-4887-02



Cawthorne
 micro crocodile scissor, 5 mm blade
 17-4888-01 Straight
 17-4888-02 Curved
 17-4888-03 Angled



Hartmann
 micro crocodile, 3 mm serrated jaws
 17-4890-02

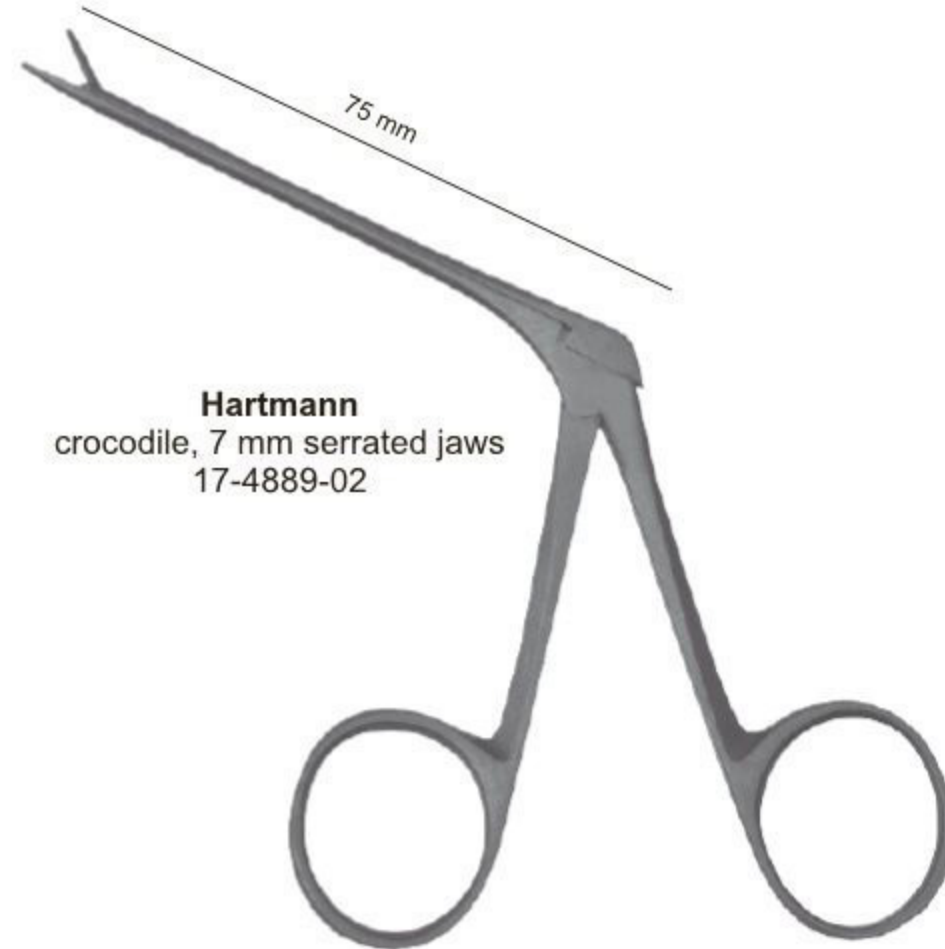

Hartmann
 crocodile, 7 mm serrated jaws
 17-4889-02

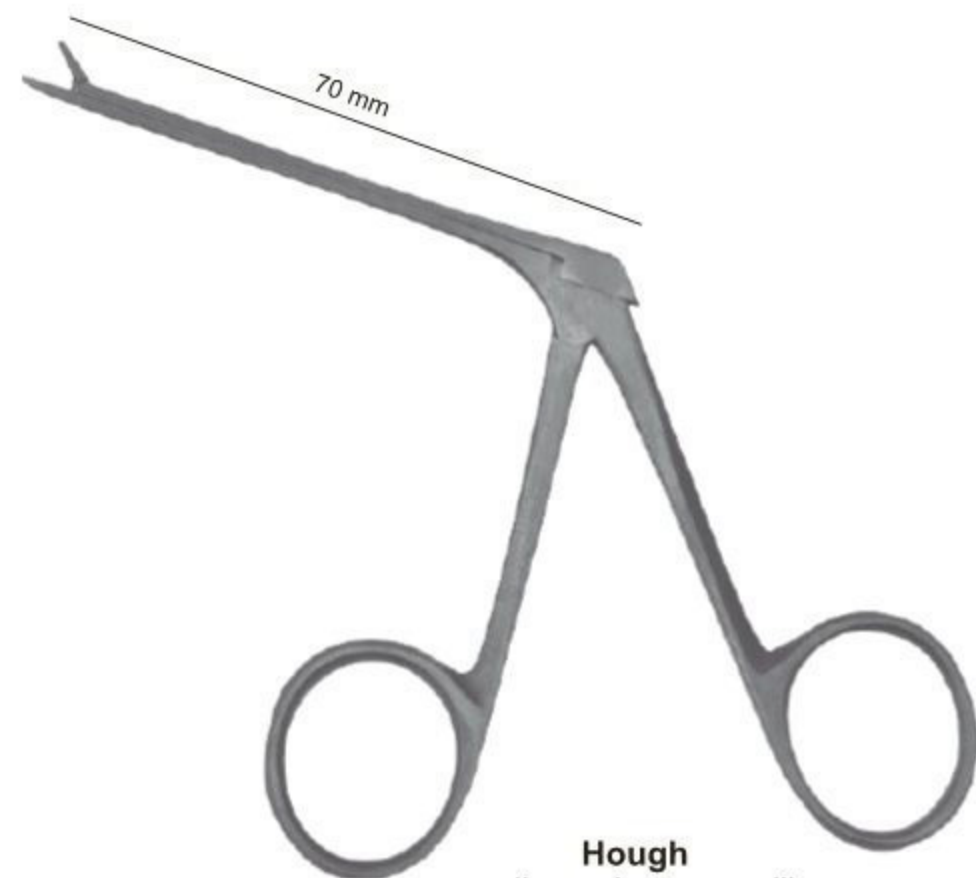

Hough
 medium micro crocodile
 5 mm serrated jaws
 17-4891-01 Straight
 17-4891-02 Angled

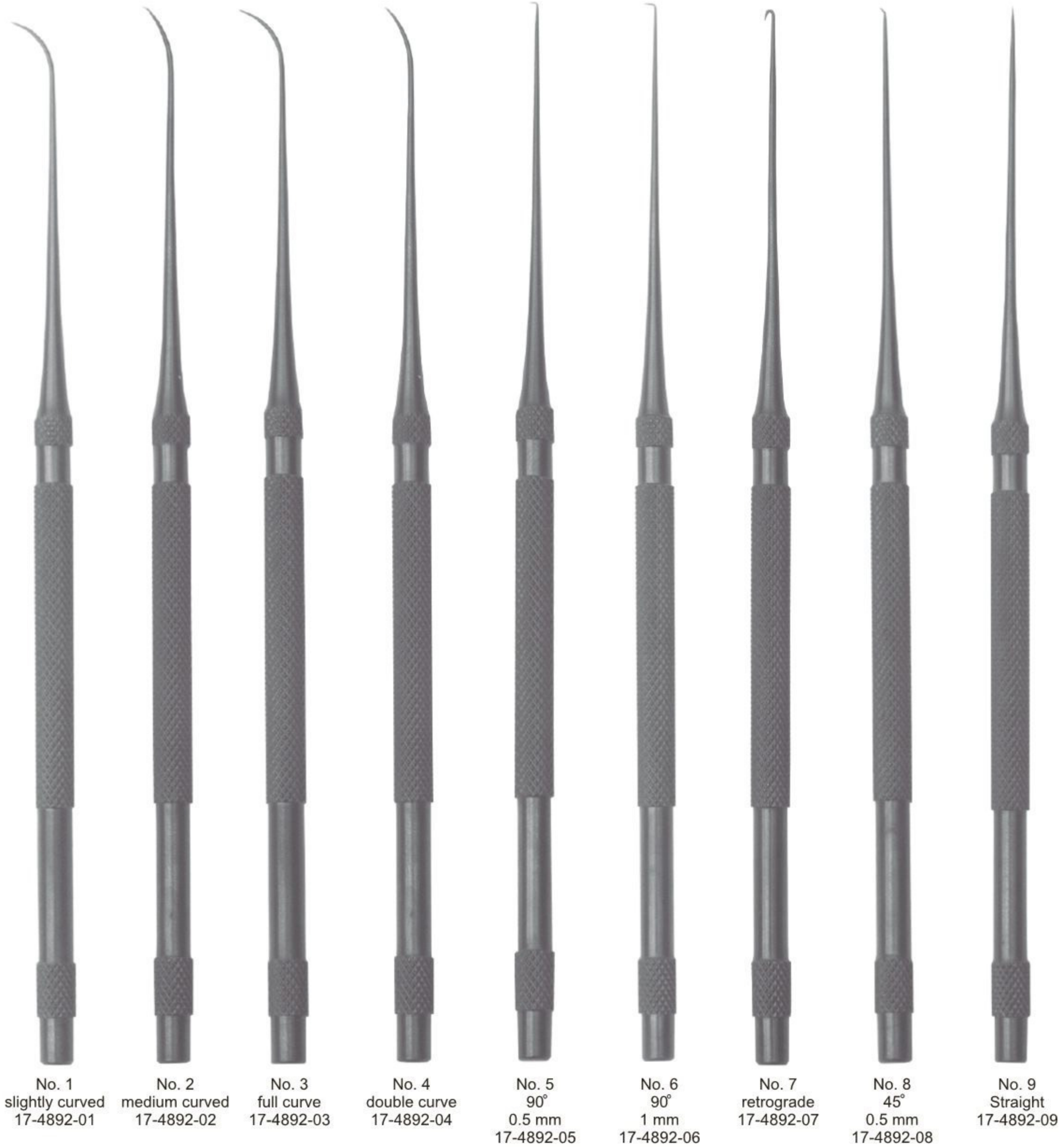

Cawthorne Stape Hook (Black Finish)
 16.5cm / 6 1/2"
 17-4892-10 (set of 9)

Messer



Schuknecht
17-4893-01

Schuknecht
17-4894-02

Schuknecht
17-4895-01

Knives



Wullstein
17-4896-01



Tabb
17-4897-01



Plester
17-4898-01



Plester
17-4899-02

17-4900-03



Rosen

17-4904-20
2.0 mm



17-4901-10
1.0 mm



17-4905-26
2.6 mm



17-4902-14
1.4 mm



17-4906-28
2.8 mm



17-4903-16
1.6 mm



17-4907-30
3.0 mm

Needles And Hooks

Barbara
17-4908-01

Rosen
17-4908-04

Barbara

25°
 17-4909-03 0.3 mm
 17-4909-06 0.6 mm
 17-4909-10 1.0 mm

45°
 17-4910-03 0.3 mm
 17-4910-06 0.6 mm
 17-4910-10 1.0 mm
 17-4910-12 1.2 mm
 17-4910-15 1.5 mm
 17-4910-20 2.0 mm
 17-4910-25 2.5 mm

90°
 17-4911-03 0.3 mm
 17-4911-06 0.6 mm
 17-4911-10 1.0 mm
 17-4911-12 1.2 mm
 17-4911-15 1.5 mm
 17-4911-20 2.0 mm
 17-4911-25 2.5 mm

17-4908-02
17-4908-03
17-4912-05 0.5 mm
17-4912-10 1.0 mm

Needles And Hooks



90°
 17-4913-03 0.3 mm
 17-4913-06 0.6 mm
 17-4913-10 1.0 mm

90°
 17-4914-03 0.3 mm
 17-4914-06 0.6 mm
 17-4914-10 1.0 mm

McGee
 17-4915-05 0.5 mm
 17-4915-10 1.0 mm

McGee
 17-4916-05 0.5 mm
 17-4916-10 1.0 mm



Barbara
 17-4917-01

Rosen
 17-4917-02

25°
 17-4918-03 0.3 mm
 17-4918-06 0.6 mm
 17-4918-10 1.0 mm

25°
 17-4919-03 0.3 mm
 17-4919-06 0.6 mm
 17-4919-10 1.0 mm

45°
 17-4920-03 0.3 mm
 17-4920-06 0.6 mm
 17-4920-10 1.0 mm

45°
 17-4921-03 0.3 mm
 17-4921-06 0.6 mm
 17-4921-10 1.0 mm

Dissectors, Measuring Road, Elevators, Currettes and Mobilizer



Fisch



17-4922-01



17-4922-02



17-4922-03



17-4922-04



Rosen

17-4923-15 1.5 mm
 17-4923-25 2.5 mm



Rosen



17-4924-01



17-4924-02



17-4924-03



17-4924-04



17-4924-05



17-4924-06



House



17-4925-01
 3.5 mm



17-4925-02
 4.0 mm



17-4925-03
 4.5 mm



17-4925-04
 5.0 mm



Buckingham



17-4926-01



17-4926-02



17-4926-03



St. Bart Blunt Hook
 17-4927-18
 18 cm / 7"



House
 17-4928-10 1.0/1.2 mm
 17-4928-15 1.5/1.8 mm



House
 17-4929-10 1.0/1.2 mm
 17-4929-15 1.5/1.8 mm



Shea
 17-4930-15 1.5 mm



Negus Aspiration
 17-4931-18
 21 cm / 8 1/4"



Jobson Horne Probe
 one side serrated
 one side ring
 17-4932-17
 17.5 cm / 7"



Zollner

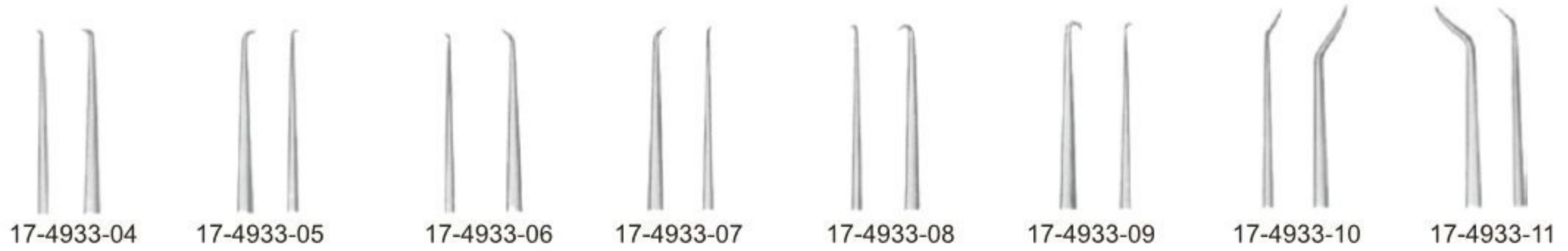



Width of Bite

Citelli
 17-4934-20 2.0 mm
 17-4934-30 3.0 mm



Width of Bite

Citelli-Beyer
 17-4935-15 1.5 mm
 17-4935-20 2.0 mm



Width of Bite



Brunings
 17-4936-40
 17-4936-60

-  17-4937-30 3.0 mm
-  17-4937-40 4.0 mm
-  17-4937-50 5.0 mm
-  17-4937-60 6.0 mm



Kerrison
 20 cm/8"

EN Rhinology

DE Rhinologie

ES Rinología

Page 438 to 462





Fraenkel
 18-5001-01 Fig. 1
 18-5001-02 Fig. 2
 18-5001-03 Fig. 3



18-5002-01
 18-5002-02
 18-5002-03
 13 cm/5"



Fig. 1
 18-5003-01
 18-5003-01

Fig. 2
 18-5004-02
 18-5004-02

Fig. 3
 18-5005-03
 18-5005-03



18-5006-01
 18-5006-02
 18-5006-03
 13 cm/5"



Hartmann
 15 cm/6"

18-5007-01

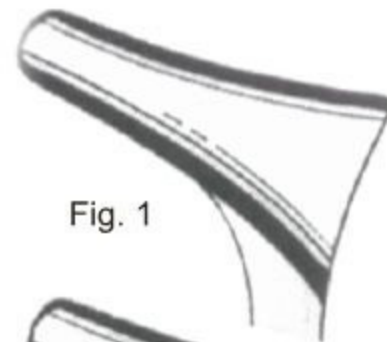

Fig. 1

18-5008-01

18-5007-02

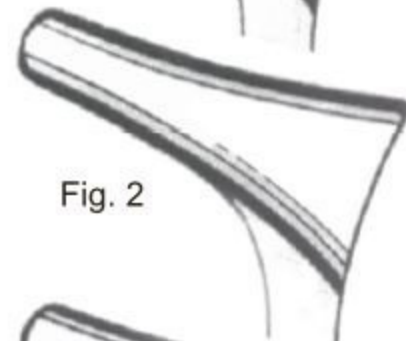

Fig. 2

18-5008-02

18-5007-03

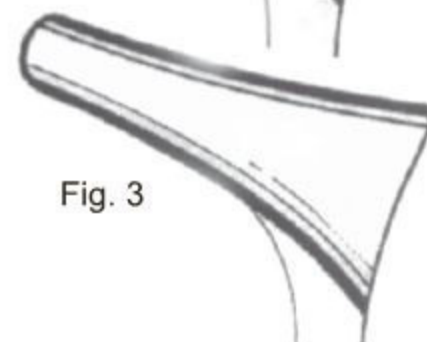

Fig. 3

18-5008-03



Hartmann
 15 cm/6"



18-5009-01

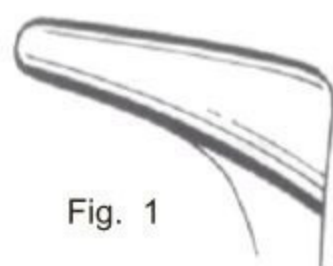

Fig. 1

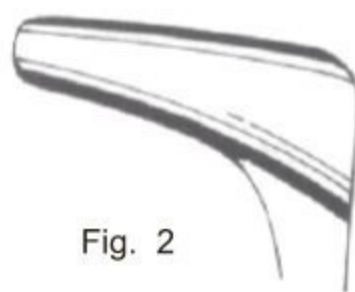

Fig. 2

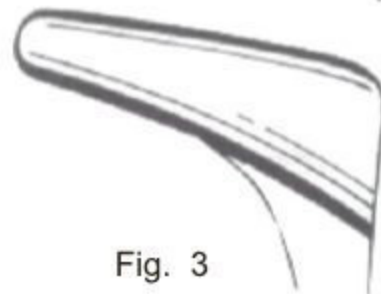

Fig. 3

18-5009-02

18-5009-03

Hartmann-Halle
 15 cm/6"



18-5010-01

18-5010-02

18-5010-03

Hartmann-Halle
 15 cm/6"



18-5011-01

18-5011-02

Tieck
 13.5 cm/5¼"



18-5012-01

18-5012-02



Tieck
 13.5 cm/5¼"



Beckmann
 15 cm/6"

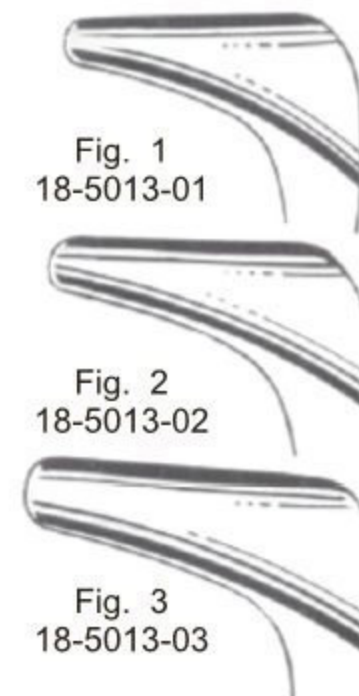

Fig. 1
 18-5013-01

Fig. 2
 18-5013-02

Fig. 3
 18-5013-03



18-5014-01



18-5015-01



18-5014-02

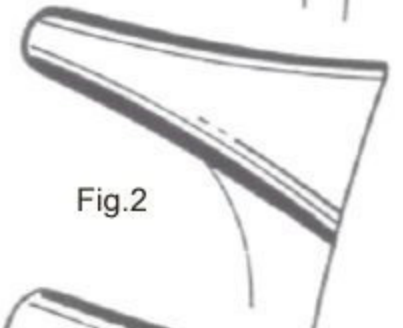

18-5015-02

18-5014-03

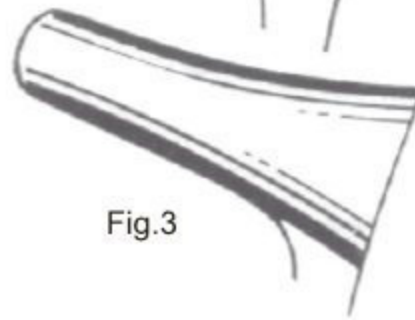

18-5015-03



18-5016-01
35 mm



18-5016-02
50 mm



18-5016-03
75 mm



18-5016-04
90 mm

Nasal Speculas ● EN
 Nasenspekula ● DE
 Espéculos nasales ● ES



Cottle
 18-5017-01
 18-5017-02
 18-5017-03
 18-5017-04
 15 cm/6"

Cottle
 18-5018-01
 18-5018-02
 18-5018-03
 18-5018-04
 15 cm/6"



Fig 1
 18-5017-01
 18-5018-01
 35 mm



Fig 2
 18-5017-02
 18-5018-02
 50 mm



Fig 3
 18-5017-03
 18-5018-03
 75 mm

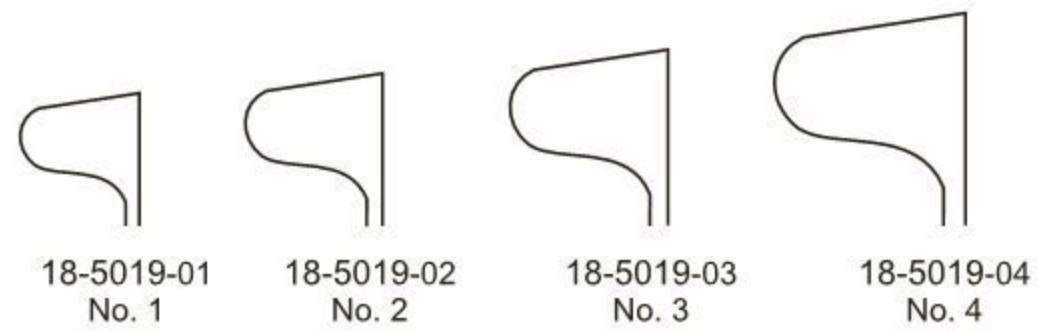

Fig 4
 18-5017-04
 18-5018-04
 90 mm



Thudicum Nasal Speculum
 Length 7 cm

- 18-5019-30 No. 1-3 (set of 3)
- 18-5019-40 No. 1-4 (set of 4)
- 18-5019-70 No. 1-7 (set of 7)



18-5019-01
 No. 1

18-5019-02
 No. 2

18-5019-03
 No. 3

18-5019-04
 No. 4

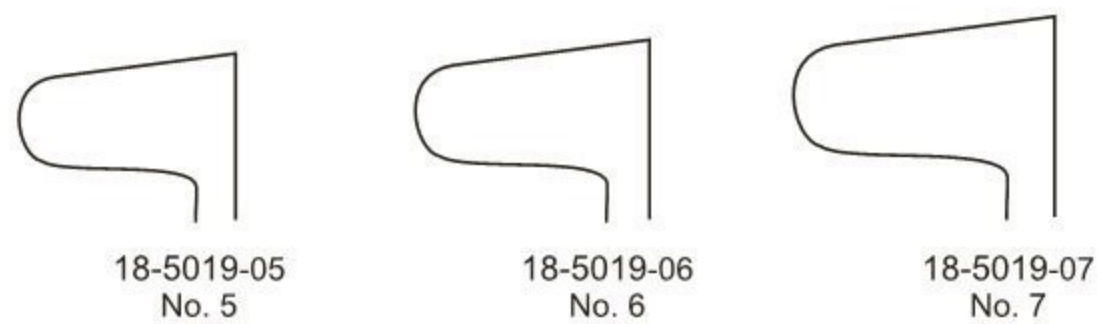

18-5019-05
 No. 5

18-5019-06
 No. 6

18-5019-07
 No. 7

- EN —● Nasal Snares, Dressing and Tampon Forceps
- DE —● Polypensnürer, Tamponpinzetten und -zangen
- ES —● Polipótomos, Pinzas para compresas y tanopamientos



Krause
 18-5020-26
 26 cm/10¼"



Krause-Voss
 18-5021-26
 26 cm/10¼"



Lange-Wilde
 18-5022-24
 24 cm/9½"

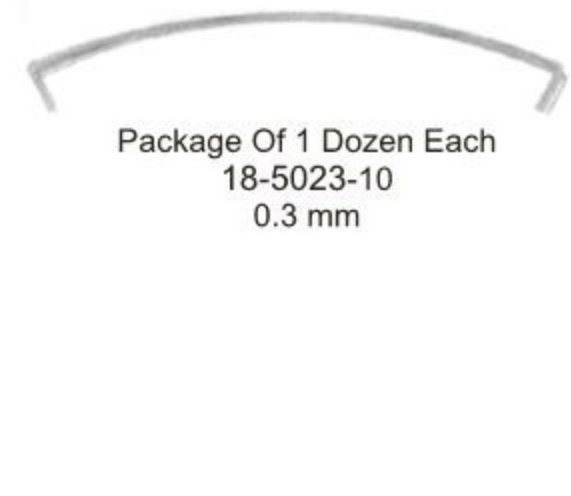

Package Of 1 Dozen Each
 18-5023-10
 0.3 mm



Cm	In
15.0	6
18.0	7
20.0	8

Troeltsch (Wilde)

18-5024-15
 18-5024-18



Gruenwald (Jansen)

18-5025-16
 18-5025-18
 18-5025-20



Westmacott (West)
 18-5026-20
 20 cm/8"



Lubet-Barbon
 18-5027-20
 20 cm/8"

Nasal Polypus and Septum Compression Forceps ● EN

Polypenzangen, Septumzange ● DE

Pinzas para pólipos, Pinza para el tabique nasal ● ES



Hartmann
18-5028-16
16 cm/6 1/4"

Hartmann
18-5029-20
20 cm/8"

Heymann
18-5030-18
18 cm/7"

Craig
18-5031-18
18 cm/7"

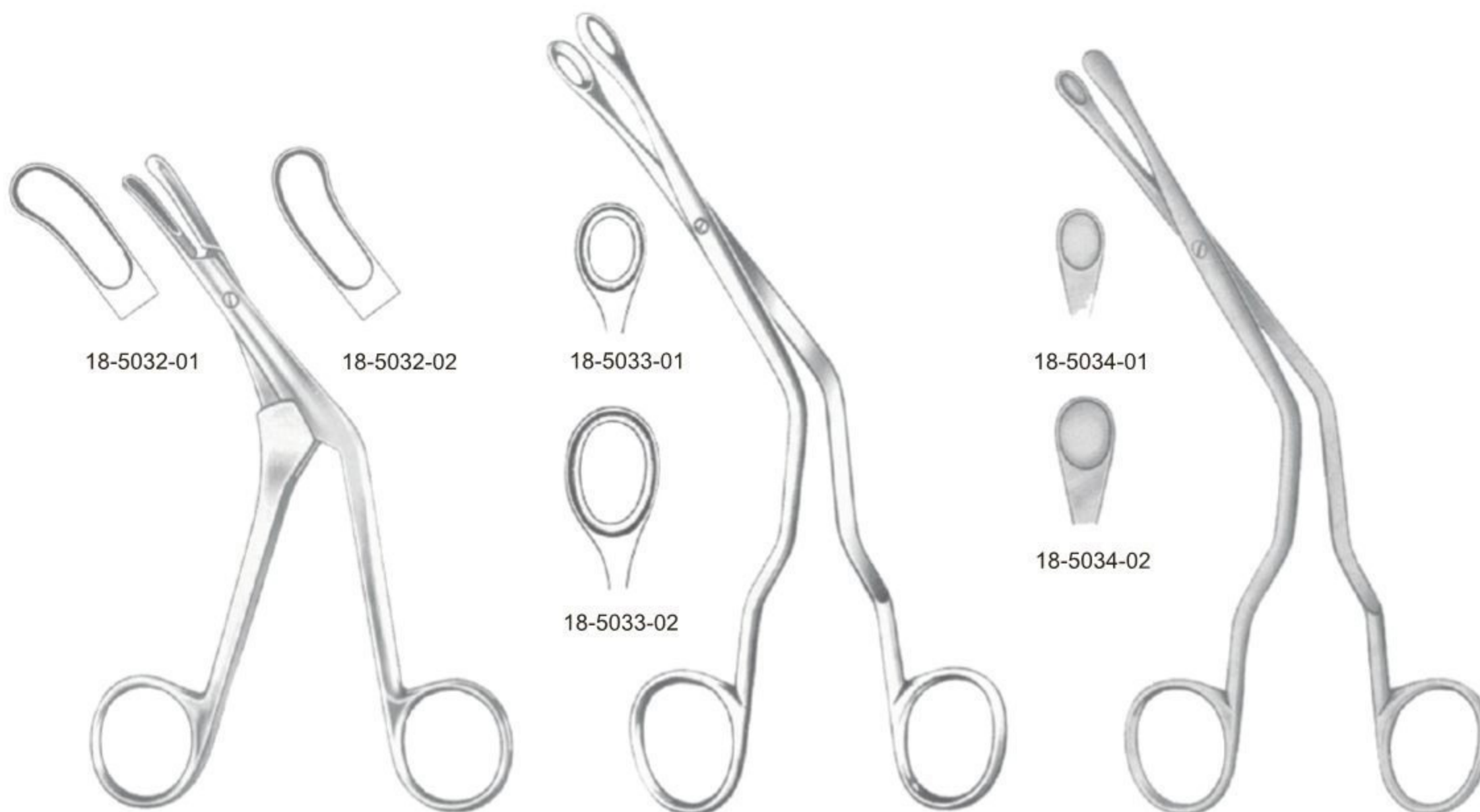

18-5032-01

18-5032-02

18-5033-01

18-5034-01

18-5033-02

18-5034-02

Craig Domnick
18 cm/7"

Luc
20 cm/8"

Luc
20 cm/8"



Bruenings
 19 cm/7½"

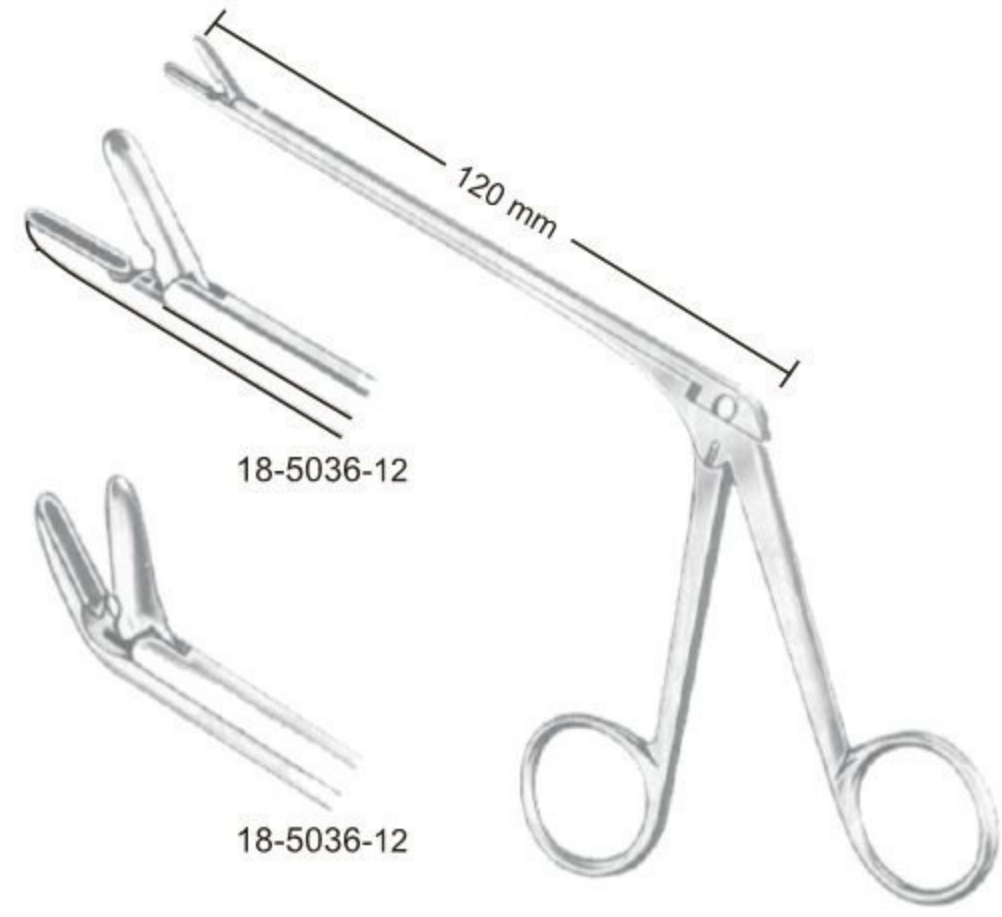

Takahashi
 19 cm/7½"



Watson-Williams
 19 cm/7½"



Ferris-Smith
 18-5038-12
 19 cm/7½"

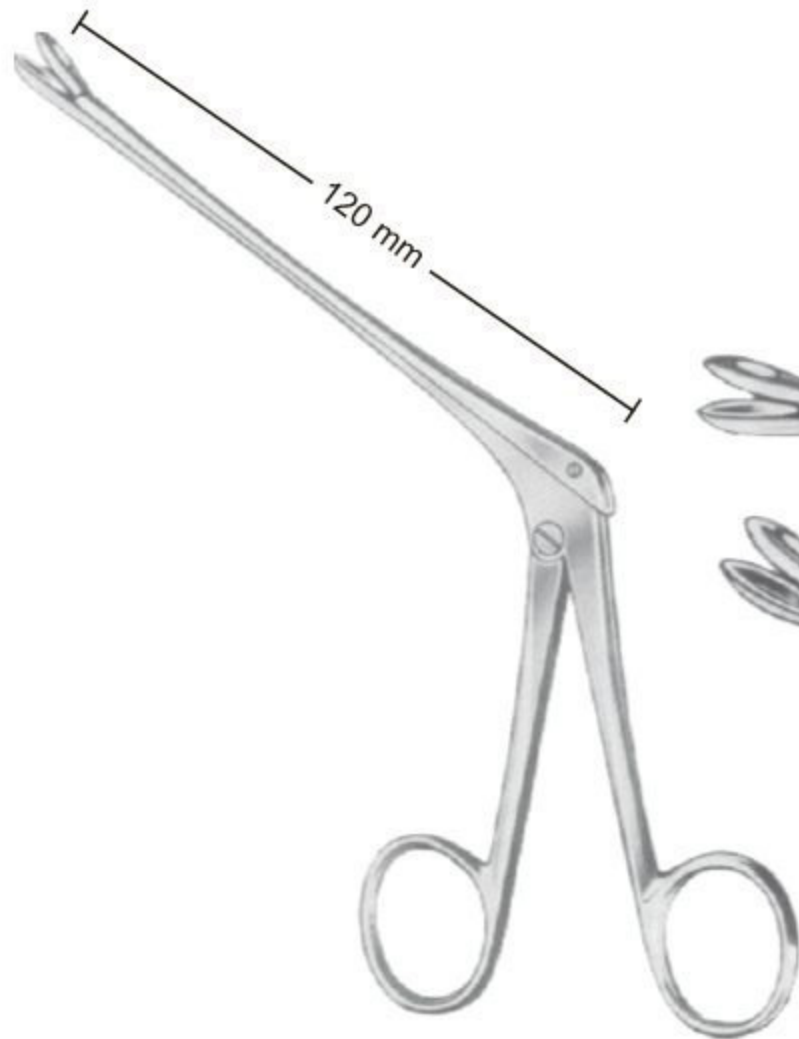

Weil-Blakesley

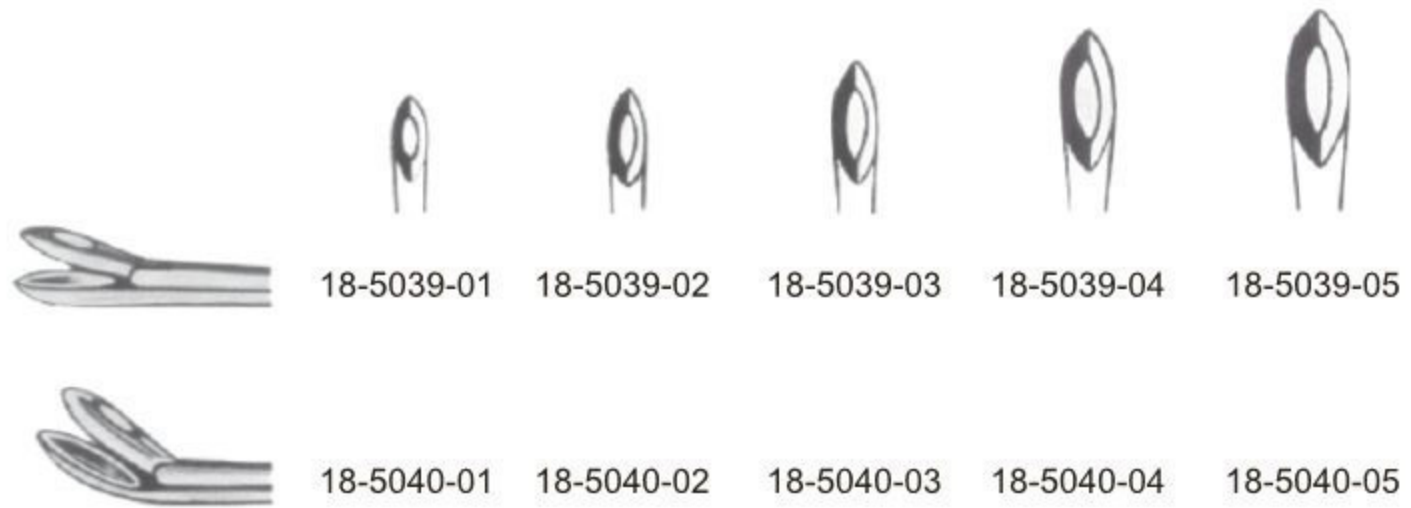

- | | | | | |
|------------|------------|------------|------------|------------|
| 18-5039-01 | 18-5039-02 | 18-5039-03 | 18-5039-04 | 18-5039-05 |
| 18-5040-01 | 18-5040-02 | 18-5040-03 | 18-5040-04 | 18-5040-05 |



Struycken

- | |
|------------|
| 18-5041-01 |
| 18-5041-02 |



Hajek

- | | |
|------------|--------|
| 18-5042-01 | 2.2 mm |
| 18-5042-02 | 2.6 mm |
| 18-5042-03 | 3.0 mm |
| 18-5042-04 | 3.4 mm |



Myles

- | |
|------------|
| 18-5043-01 |
| 18-5043-02 |
| 18-5043-03 |



Grunwald

- | |
|------------|
| 18-5044-01 |
| 18-5044-02 |
| 18-5044-03 |



Hartmann

- | | |
|------------|-------|
| 18-5046-01 | 5 mm |
| 18-5046-02 | 7 mm |
| 18-5046-03 | 9 mm |
| 18-5046-04 | 11 mm |



Schmeden

- | |
|------------|
| 18-5047-01 |
| 18-5047-02 |
| 18-5047-03 |



Grunwald
 18-5045-01



Middleton-Jansen
 18-5048-19
 19 cm/7½"

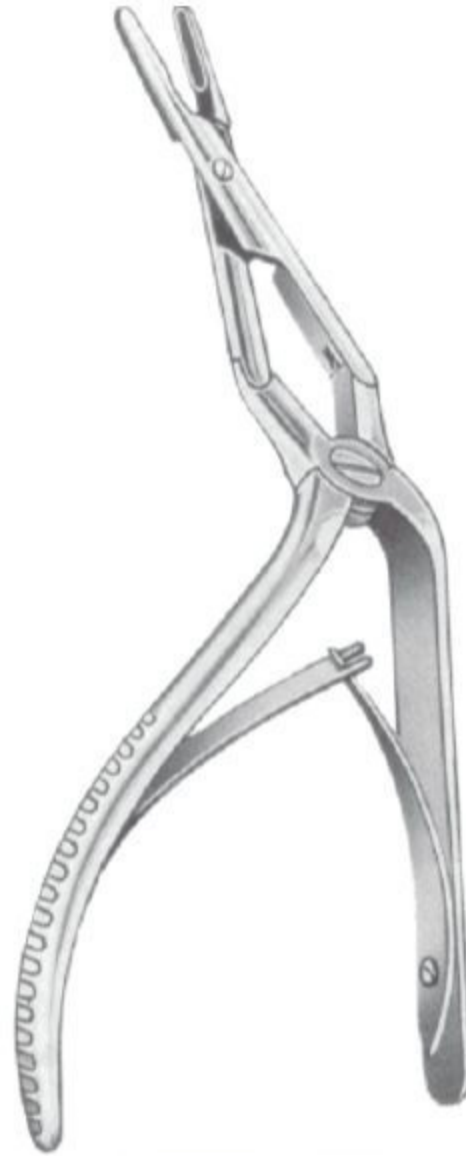

Middleton-Jansen
 18-5049-19
 19 cm/7½"



Kazanjian
 18-5050-18
 18 cm/7"



Caplan
 18-5051-20
 20 cm/8"

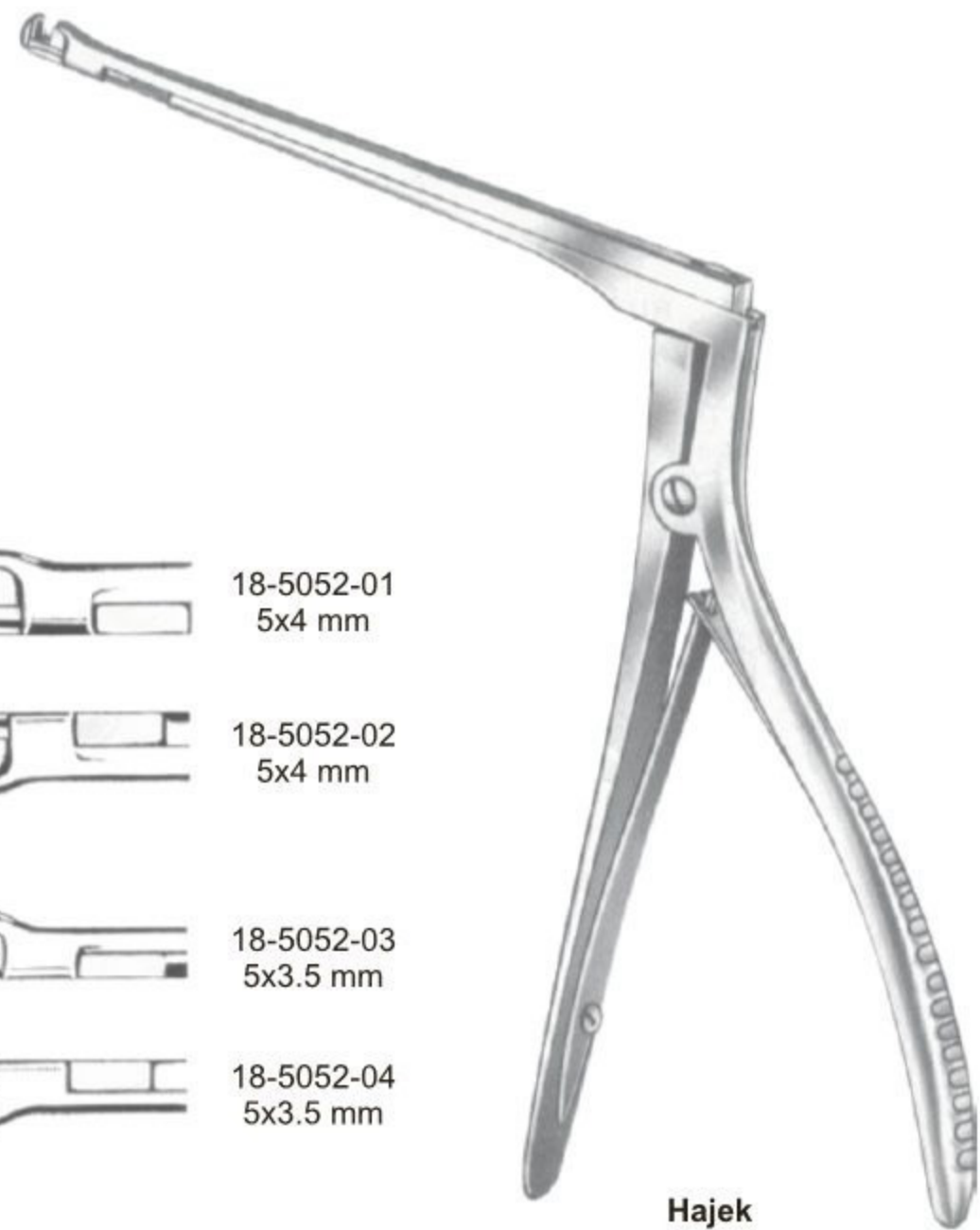
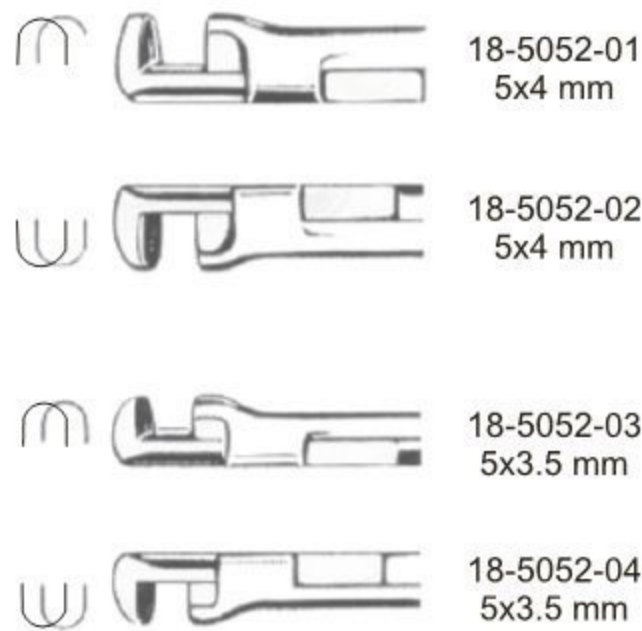



**Hajek
 (Hajek-Kofler)
 Shaft**
 14 cm/5½"



Ferris-Smith-Kerrison



Ferris-Smith-Kerrison

	Width of Bite	Length of Shaft			Width of Bite	Length of Shaft		
		15 cm/6"	20 cm/8"	18 cm/7"		15 cm/6"	20 cm/8"	18 cm/7"
Cutting Upward 	18-5053-03	3 mm	18-5056-03	18-5059-03	1 mm	18-5061-03	18-5064-03	18-5067-01
	18-5053-05	5 mm	18-5056-05	18-5059-05	2 mm			18-5067-02
					3 mm			18-5067-03
					4 mm			18-5067-04
					5 mm			18-5067-05
Cutting Upward 40° 	18-5054-03	3 mm	18-5057-03		1 mm	18-5062-03	18-5065-03	18-5068-01
	18-5054-05	5 mm	18-5057-05		2 mm			18-5068-02
					3 mm			18-5068-03
					4 mm			18-5068-04
					5 mm			18-5068-05
Cutting Downward 	18-5055-03	3 mm	18-5058-03	18-5060-03	1 mm	18-5063-03	18-5066-03	18-5069-01
	18-5055-05	5 mm	18-5058-05	18-5060-05	2 mm			18-5069-02
					3 mm			18-5069-03
					4 mm			18-5069-04
					5 mm			18-5069-05



360° Turnable

Hajek-Kofler
 18-5070-16
 16 cm/6½"

- 18-5071-03
3 mm
- 18-5071-04
4 mm
- 18-5071-05
5 mm
- 18-5071-06
6 mm



Kerrison
 20 cm/8"

- EN —● Adenoid Cutting Forceps and Nasal Knives
- DE —● Adenoid Cutting Pinzetten und Nasal Messer
- ES —● Adenoides pinzas de cortar y cuchillos nasal



Jurasz
 22 cm/8¾"



18-5072-01

18-5072-02

18-5072-03

Rhinoplastic and Nasal Knives

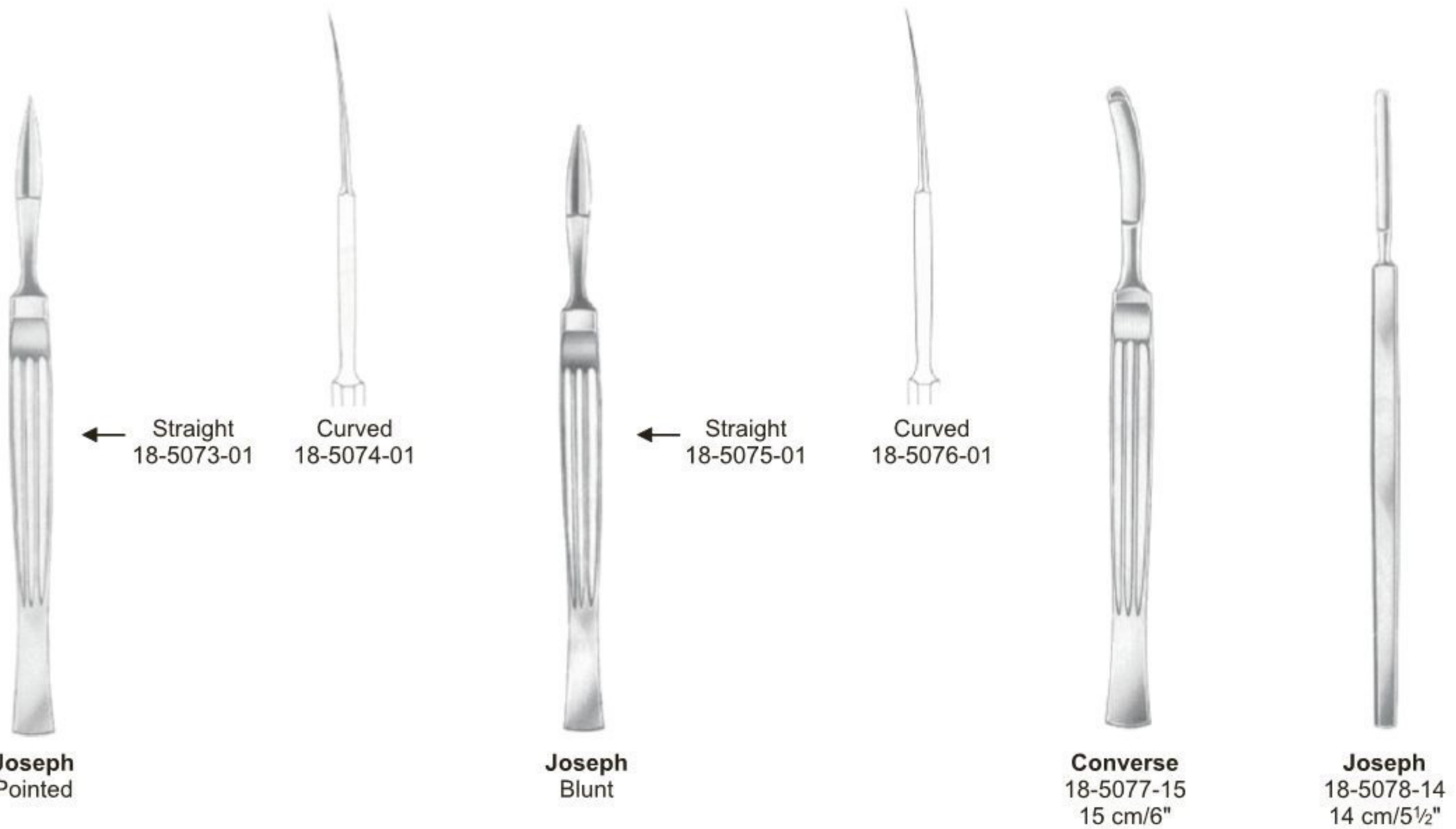

← Straight
 18-5073-01

Curved
 18-5074-01

← Straight
 18-5075-01

Curved
 18-5076-01

Joseph
 Pointed

Joseph
 Blunt

Converse
 18-5077-15
 15 cm/6"

Joseph
 18-5078-14
 14 cm/5½"



Cottle
 18-5079-15
 15 cm/6"



Cottle
 18-5080-14
 14 cm/5½"



Freer
 18-5081-16
 16 cm/6¼"



Joseph
 18-5082-16
 16.5 cm/6½"



Maltz
 18-5083-16
 16.5 cm/6½"



Freer
 18-5084-19
 19 cm/7½"

Septum Knives



Ballenger
 20cm/8"



18-5085-03 3 mm 18-5086-03
 18-5085-04 4 mm 18-5086-04
 18-5085-05 5 mm 18-5086-05



Ballenger
 20cm/8"



Bruenings
 18-5087-16



Mc Kenty
15 cm/6"

18-5088-04 4 mm
18-5088-05 5 mm



Halle
18-5089-16
16.5 cm/6½"



Joseph
18-5090-16
16.5 cm/6½"



Cottle
18-5091-19
19.5 cm/7½"



Blunt

Freer
18-5092-19
19 cm/7½"



Sharp

Freer
18-5093-19
19 cm/7½"



Freer
18-5094-18
18 cm/7"



Freer-Yasargil
18-5095-18
18.5 cm/7¼"



Howarth
18-5096-21
21.5 cm/8½"



Mc Kenty
18-5097-22
22 cm/8¾"



Killian
18-5098-18
18.5 cm/7¼"



Cottle
18-5099-23
23 cm/9"



Killian
18-5100-18
18.5 cm/7¼"



Pierce
18-5101-21
21 cm/8¼"



Pennington
18-5102-21
21 cm/8¼"

Raspatories



18-5103-18
18 cm/7"



**Joseph (Cottle)
Masing**
18-5104-22
22 cm/8¾"



Masing
18-5105-20
20.5 cm/8⅜"

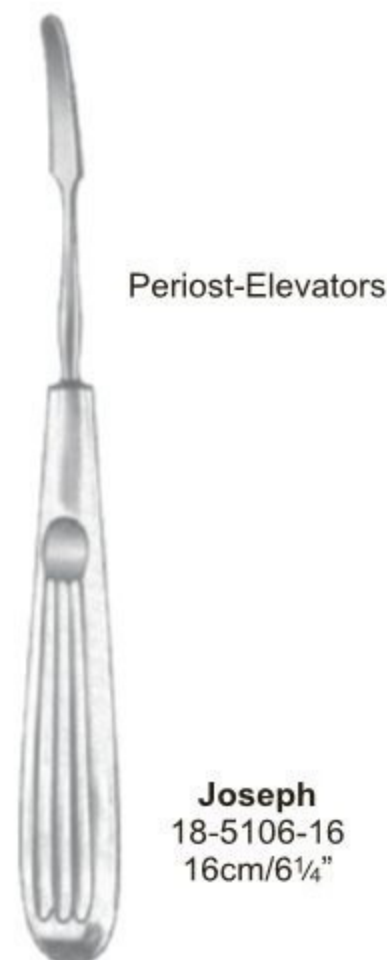

Periost-Elevators

Joseph
18-5106-16
16cm/6¼"

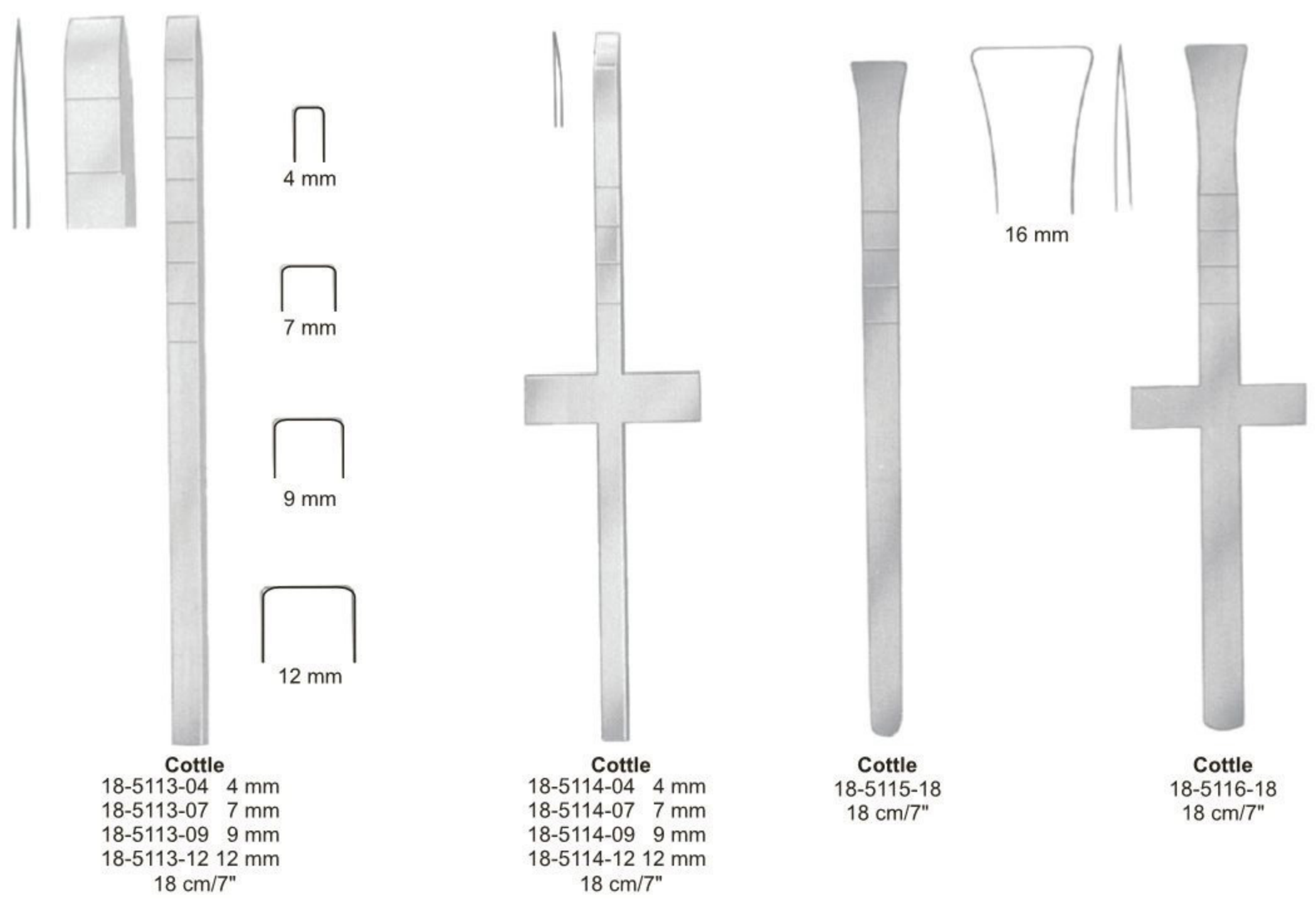
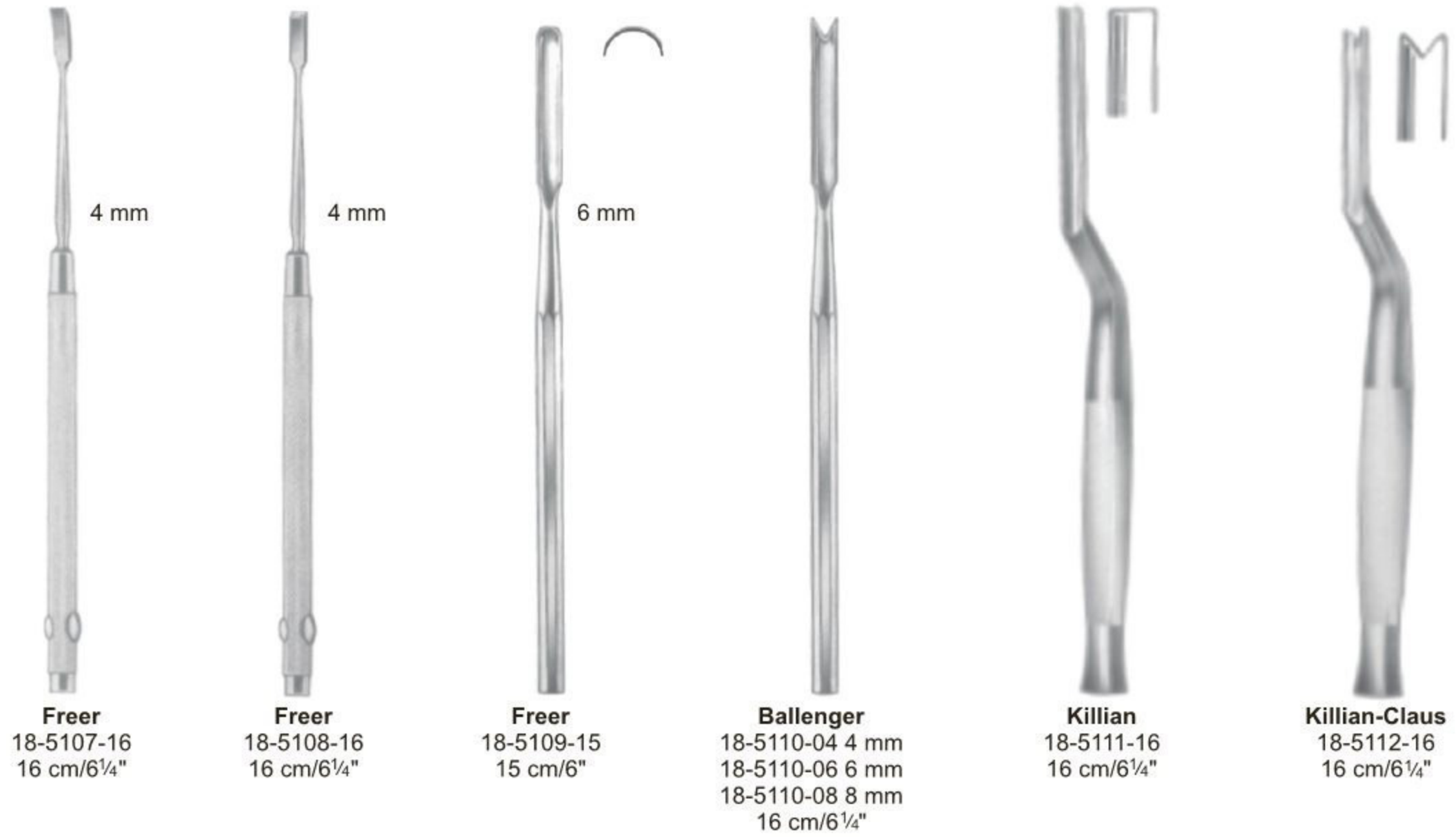

Nasal Septum Chisels ● EN
 Nasenscheidewand Meißel ● DE
 Tabique nasal Cinceles ● ES



18-5117-08
 16 cm/6¼"
 8 mm



Cottle
 18-5118-04 4 mm
 18-5118-07 7 mm
 18-5118-09 9 mm
 18-5118-12 12 mm
 18 cm/7"



Cottle
 Curved
 18-5119-06
 18 cm/7"
 6 mm



Fomon
 18-5120-05 5mm
 18-5120-08 8mm
 17 cm/6¾"



Walter
 18-5121-03 3 mm
 18-5121-04 4 mm
 18 cm/7"



18-5122-01



**(Silver)
 Masing**
 18-5123-02
 17.5 cm/7⅞"



18-5124-03

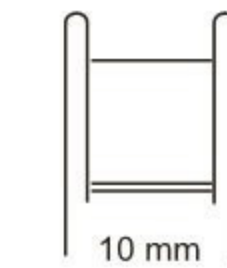

10 mm

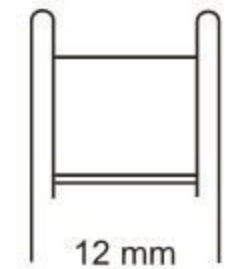

12 mm

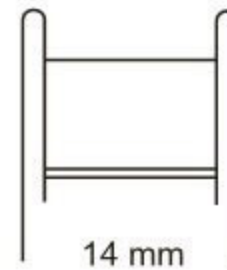

14 mm



16 mm

Cinelli
 18-5125-10 10 mm
 18-5125-12 12 mm
 18-5125-14 14 mm
 18-5125-16 16 mm
 16 cm/6¼"



Masing
 18-5126-17
 17.5 cm/6⅞"



West
 18-5127-16
 16 cm/6¼"



West
 18-5128-16
 16 cm/6¼"



18-5129-01

18-5129-02

Joseph
 17 cm/6¾"



Joseph
 18-5130-01
 17 cm/6¾"



Joseph
 18-5131-02
 17 cm/6¾"



Joseph
 18-5132-03
 17 cm/6¾"

Rasps with TC ●— EN
 Raspeln mit TC ●— DE
 Escofinas con TC ●— ES

TC



Fig.1



Fig.3



Fig.5



Fig.7



Fig.9



Fig.2



Fig.4



Fig.6



Fig.8



Fig.10

Famon

- Fig. 1/ 2 18-5133-12
- Fig. 3/ 4 18-5133-34
- Fig. 5/ 6 18-5133-56
- Fig. 7/ 8 18-5133-78
- Fig. 9/10 18-5133-90

21 cm/8 1/4"

TC



Parkes

- Fig. 1 18-5134-01
- Fig. 2 18-5134-02
- Fig. 3 18-5134-03
- Fig. 4 18-5134-04
- Fig. 5 18-5134-05
- Fig. 6 18-5134-06
- Fig. 7 18-5134-07
- Fig. 8 18-5134-08
- Fig. 9 18-5134-09
- Fig.10 18-5134-10

20.5 cm/8 1/8"

Maltz

- Fig. 1 18-5135-01
- Fig. 2 18-5135-02
- Fig. 3 18-5135-03
- Fig. 4 18-5135-04
- Fig. 5 18-5135-05
- Fig. 6 18-5135-06
- Fig. 7 18-5135-07
- Fig. 8 18-5135-08
- Fig. 9 18-5135-09
- Fig.10 18-5135-10

17 cm/6 3/4"



Maltz
 18-5141-18
 18 cm/7"



Joseph
 16 cm/6¼"

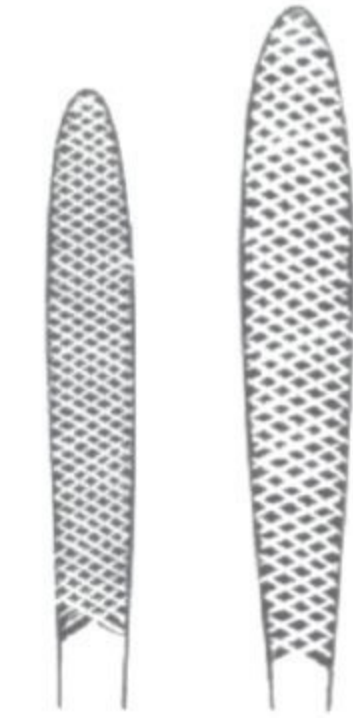

18-5142-01

18-5142-02



Lewis
 18 cm/7"



Fine
 18-5143-01



Coarse
 18-5143-02



Cottle
 18-5144-21
 21 cm/8¼"



Aufricht
 21 cm/8¼"

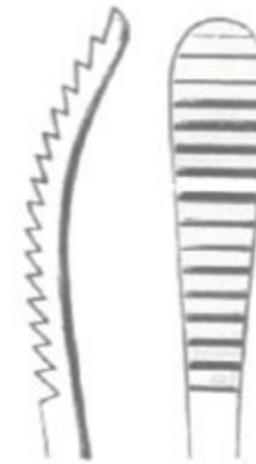

18-5145-01

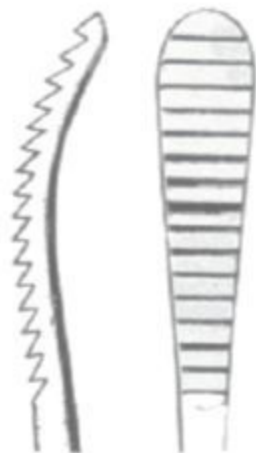

18-5145-02

Rasps with TC ●— EN
 Raspeln mit TC ●— DE
 Escofinas con TC ●— ES



Maltz
 17 cm/6¾"



18-5136-01



18-5136-02



Miller
 16 cm/6¼"

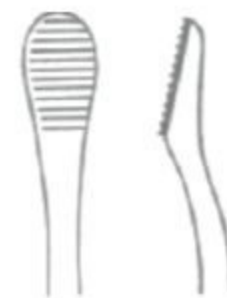

18-5137-01



18-5137-02

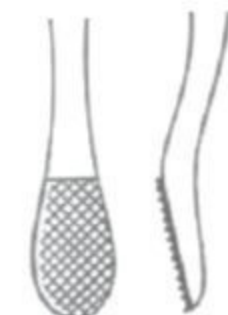
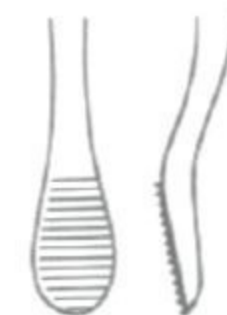

19 cm/7½"



18-5138-02



18-5138-03



18-5138-04



18-5138-05



18-5138-06



18-5138-07



Aufricht
 18-5139-17
 17.5 cm/6⅞"



Fomon
 18-5140-21
 21 cm/8¼"



Hooks

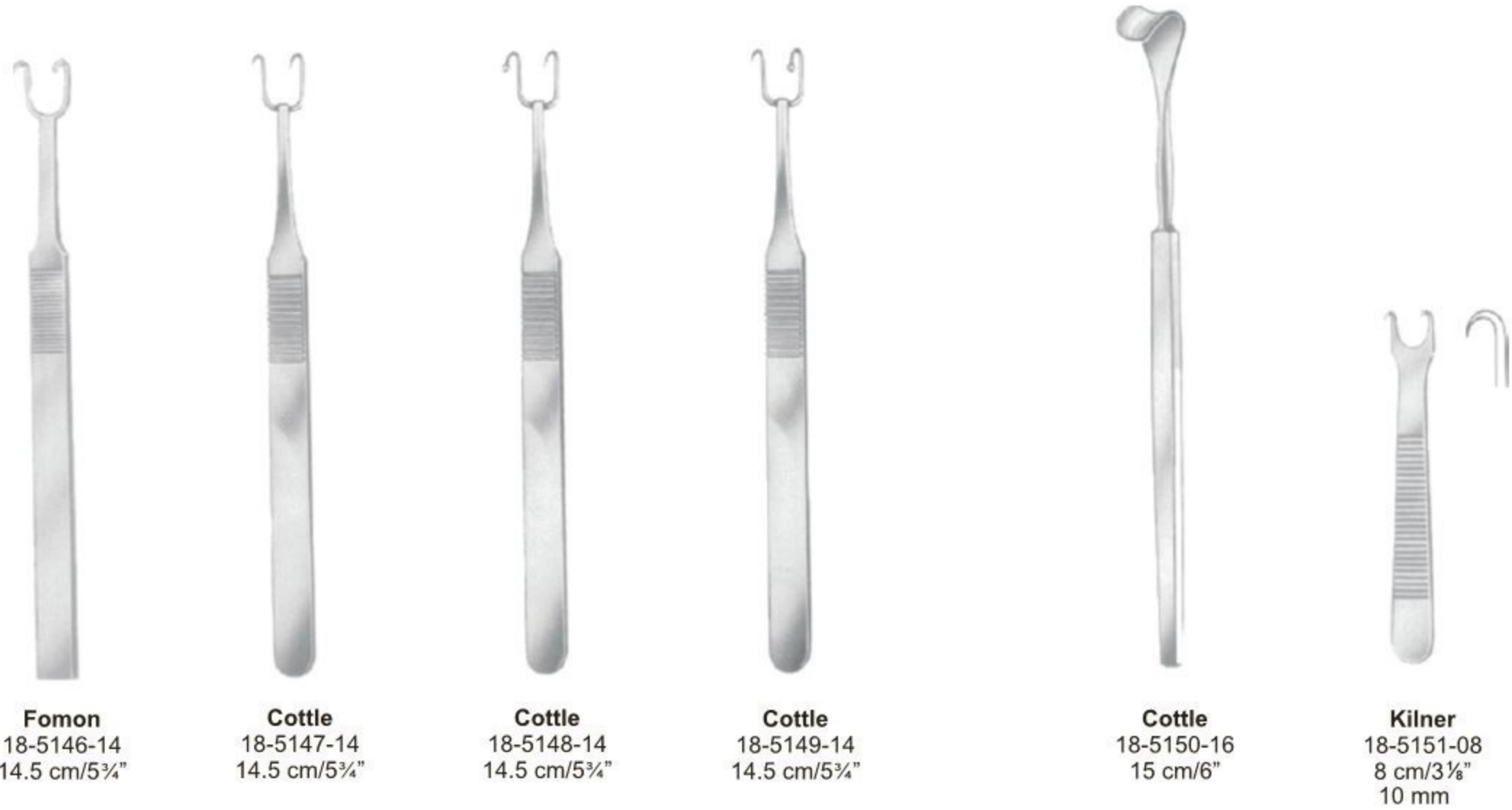

Columella Forceps



Converse
18-5152-12
12 cm/4 3/4"

Aufricht
18-5153-16
16 cm/6 1/4"



Cottle
18-5154-10
10 cm/4"

Tissue Lifter



18-5155-14
14 cm/5 1/2"

Tissue Picks



18-5156-11
11 cm/4 3/8"



1.0 mm 18-5157-10
1.8 mm 18-515718

Septum Straightening and Septum Punch Forceps ● EN
 Septum Straightening und Septum Punch-Zange ● DE
 Tabique y tabique Straightening perforación Pinzas ● ES



Walsham
 23 cm/9"



18-5158-01



18-5158-02



18-5158-03



Cottle-Walsham
 18-5159-22
 22 cm/8¾"



Asch
 18-5160-23
 23 cm/9"



Kressner
 18-5161-20
 20 cm/8"



Rubin
 18-5162-20
 20 cm/8"



Faulkner
 18-5163-21
 21 cm/8¼"



Sewall
 18-5164-20
 20 cm/8"
 6 mm



Coakley
 17 cm/6¾"



18-5165-01



18-5165-02



18-5165-03



18-5165-04



18-5165-05



18-5165-06

Ringmesser



Beckmann
 22 cm/8¾"

18-5166-01



18-5167-01

18-5166-02



18-5167-02

18-5166-03



18-5167-03

18-5166-04



18-5167-04

18-5166-05



18-5167-05

18-5166-06



18-5167-06

Adenoid Curettes



Negus
 20 cm/8"

Adenoid Currettes ● EN

Ringmesser ● DE

Cuchillos para vegetaciones adenoides ● ES

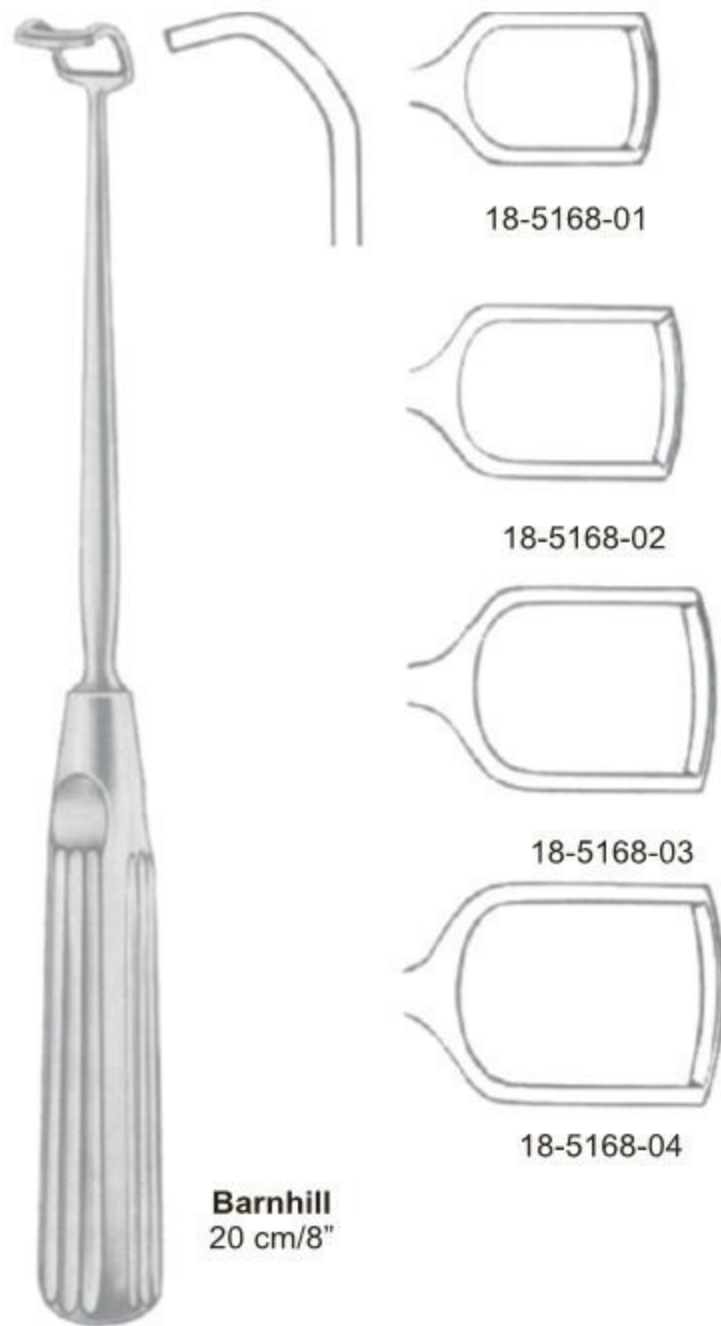

Barnhill
20 cm/8"

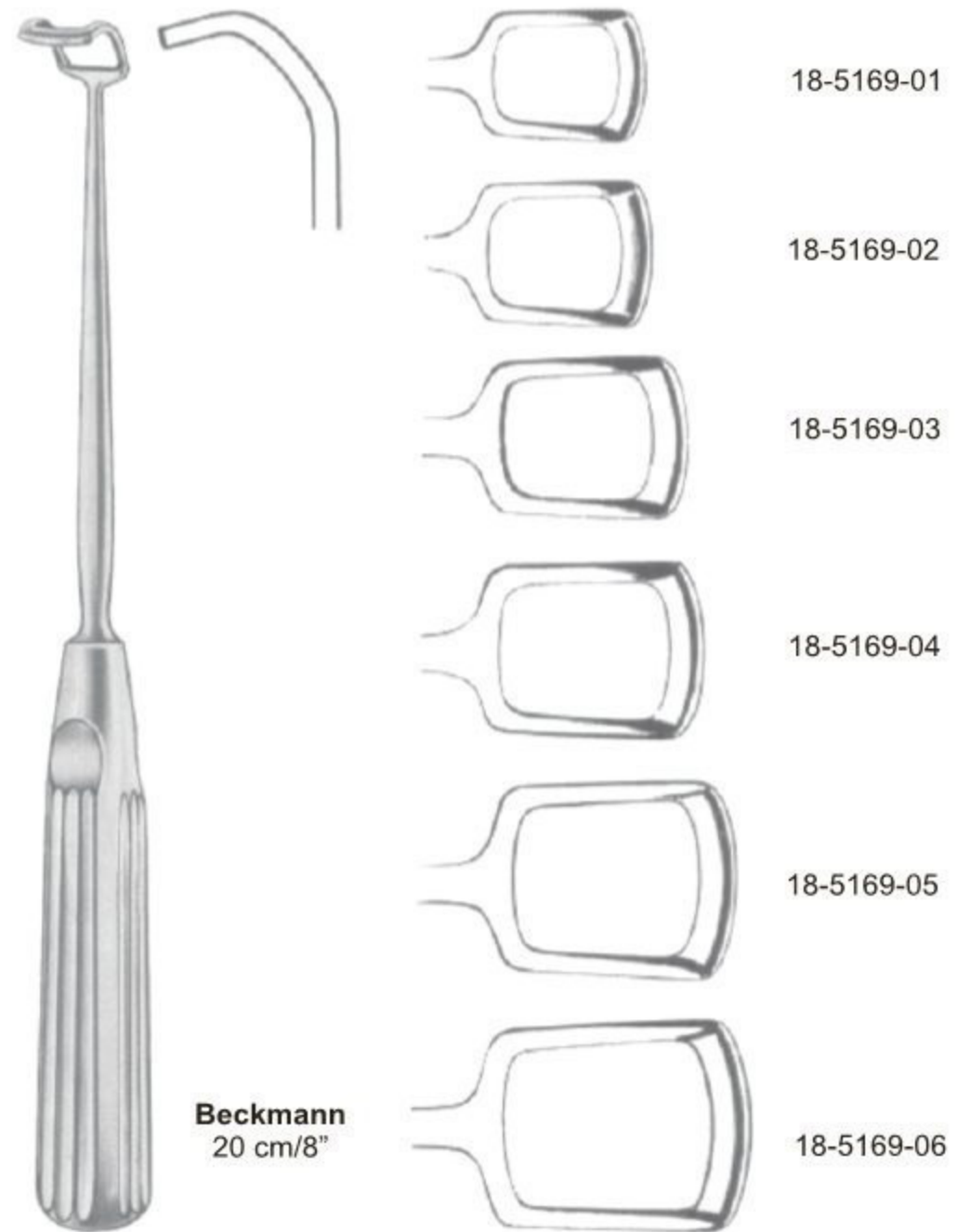

Beckmann
20 cm/8"

- 18-5170-10 10mm
- 18-5170-12 12mm
- 18-5170-14 14mm
- 18-5170-16 16mm
- 18-5170-18 18mm

- 18-5170-10A 10mm
- 18-5170-12A 12mm
- 18-5170-14A 14mm
- 18-5170-16A 16mm
- 18-5170-18A 18mm



St. Clair-Thompson
with graded
21.5cm/8 1/2"



St. Clair-Thompson
without graded
21.5cm/8 1/2"



La Force
23 cm/9"

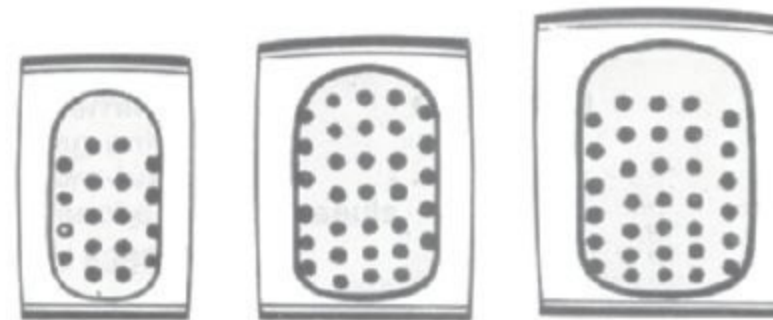

18-5171-01 18-5171-02 18-5171-03

Spare blades Only

18-5171-11 18-5171-12 18-5171-13

- EN —● Antrum Retractor and Antrum Frontal Sinus Wash Cannulas
 DE —● Nasal und Adenoid CuAntrum Retractor und Antrum Frontal Sinus Wash Kanülen
 ES —● Nasal y adenoides CuAntrum Retractor y el antro del seno frontal lavado cánulas



Bruenings- Brunk
 18-5172-19
 91 cm/7½"

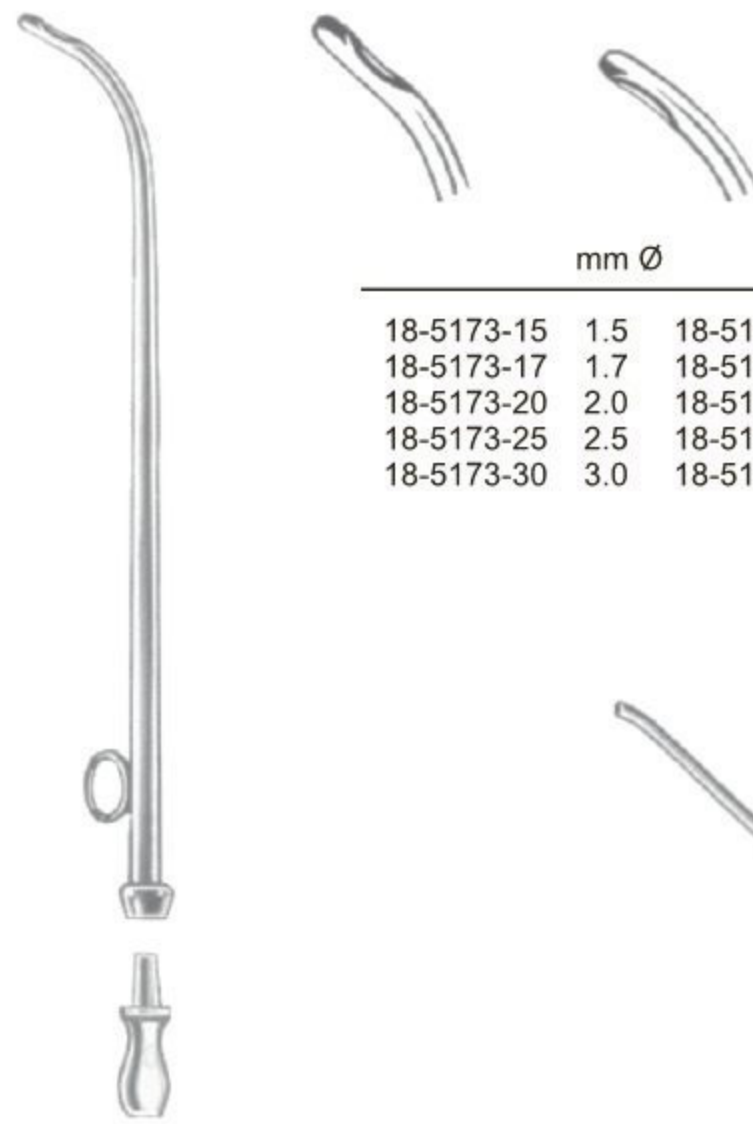

Siebenmann

mm Ø		
18-5173-15	1.5	18-5174-15
18-5173-17	1.7	18-5174-17
18-5173-20	2.0	18-5174-20
18-5173-25	2.5	18-5174-25
18-5173-30	3.0	18-5174-30



Hartmann

Fig. 1	mm Ø	Fig. 2
18-5175-20		18-5176-20
18-5175-25		18-5176-25
18-5175-30		18-5176-30



Eicken - Killian
 18-5177-03
 3 mm Ø



Killian
 18-5178-15
 1.5 mm Ø



Ritter - Halle
 2.5 mm 18-5179-25
 3.0 mm 18-5179-30
 4.0 mm 18-5179-40

- EN** Oral Instruments
- DE** Mund instrumente
- ES** Cirugía oral

Page 463 to 467



Gag Only
 19-5251-10



Fig. 1
 19-5251-01
 65 x 28 mm

Kilner-Doughty
 Complete
 19-5251-00



Fig. 2
 19-5251-02
 75 x 32 mm

Fig. 3
 19-5251-03
 80 x 37 mm

Gag Only
 19-5252-10

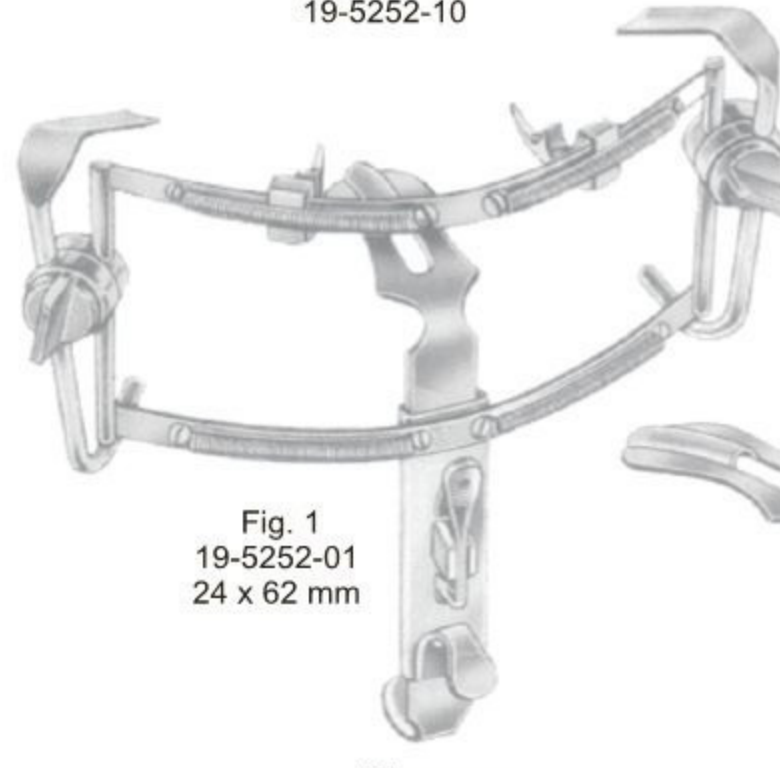

Fig. 1
 19-5252-01
 24 x 62 mm

Dingmann
 Complete
 19-5252-00



Fig. 2
 19-5252-02
 28 x 65 mm

Fig. 3
 19-5252-03
 31 x 75 mm

Gag Only
 19-5253-10



Davis-Boyle
 Complete
 19-5253-00



Fig. 3
 19-5253-03
 24 x 80 mm

Fig. 5
 19-5253-05
 26 x 108 mm

Gag Only
 19-5254-10



Mc Ivor
 Complete
 19-5254-00



Fig. 1
 19-5254-01
 23 x 70 mm

Fig. 3
 19-5254-03
 26 x 100 mm

Fig. 2
 19-5254-02
 25 x 86 mm

Fig. 1
 19-5253-01
 21 x 26 mm

Fig. 2
 19-5253-02
 23 x 65 mm

Fig. 4
 19-5253-04
 25 x 93 mm



Fig.		mm	Fig.		mm
2	19-5255-02	23 x 65	1	19-5256-01	28 x 66
3	19-5255-03	24 x 80	2	19-5256-02	32 x 75
4	19-5255-04	25 x 93	3	19-5256-03	34 x 83
5	19-5255-05	26 x 108	4	19-5256-04	37 x 93
			5	19-5256-05	38 x 100

Modell Wurzburg



Chest Support for Mouth gag
 19-5257-00



Baby-Molt
 19-5258-10
 10 cm/4"

Molt
 19-5259-11 11 cm/4 1/4"
 19-5259-14 14 cm/5 1/2"

Roser-Konig
 19-5260-16 16 cm/6 1/4"
 19-5260-19 19 cm/7 1/2"

Denhart
 19-5261-12
 12 cm/4 3/4"

Mouth Gags



Heister
 19-5262-13
 13 cm/5"



Fergusson-Ackland
 19-5263-18 18 cm/7"
 19-5263-20 20 cm/8"



Whitehead
 19-5264-11 11 cm/4 1/4"
 19-5264-13 13 cm/5"
 19-5264-15 15 cm/6"

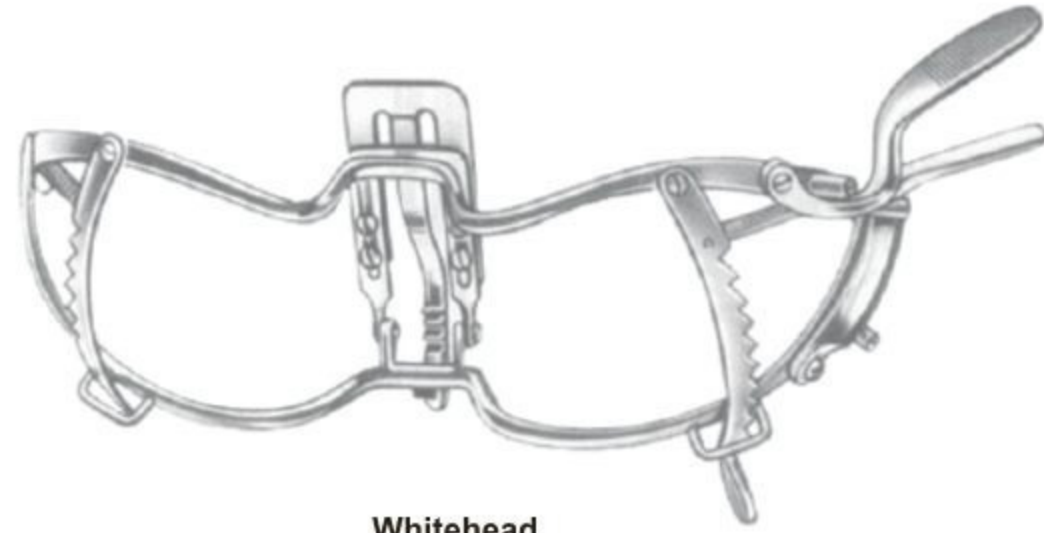

Whitehead
 19-5265-13
 13 cm/5"



Jennings
 19-5266-09 09 cm/3 1/2"
 19-5266-11 11 cm/4 1/4"
 19-5266-13 13 cm/5"
 19-5266-15 15 cm/6"



Sternberg
 19-5267-12 12 cm/4 3/4"
 19-5267-14 14 cm/5 1/2"
 19-5267-16 16 cm/6 1/4"



19-5268-19
 19 cm/7 1/2"



Moritz-Schmidt
 19-5269-19
 19 cm/7 1/2"

Tongue Depressors • EN
 Zungendrucker • DE
 Abaja-lenguas • ES



Lack
 19-5270-15
 Child 12 mm
 Adolescent 19 mm
 Adult 22mm



Hartmann
 19-5271-15
 15 cm/6"



Tobold
 19-5272-14
 14.5 cm/5 3/4"



Fraenkel
 19-5273-19
 19 cm/7 1/2"



Frenzel
 19-5274-16
 16.5 cm/6 1/2"



19-5275-13
 13 cm/5"



19-5276-14
 14.5 cm/5 3/4"



19-5277-14
 14.5 cm/5 3/4"



Kroenig
 19-5278-15
 15 cm/6"



Mayo
 19-5279-17
 17 cm/6 3/4"



Draffin Bipod
 4 rings
 19-5280-38 38.5cm/15"
 19-5280-48 48cm/19"



Bruenings
 19-5281-19
 19 cm/7½"



Bruenings
 19-5282-19
 19 cm/7½"



Wieder



19-5283-01



19-5283-02

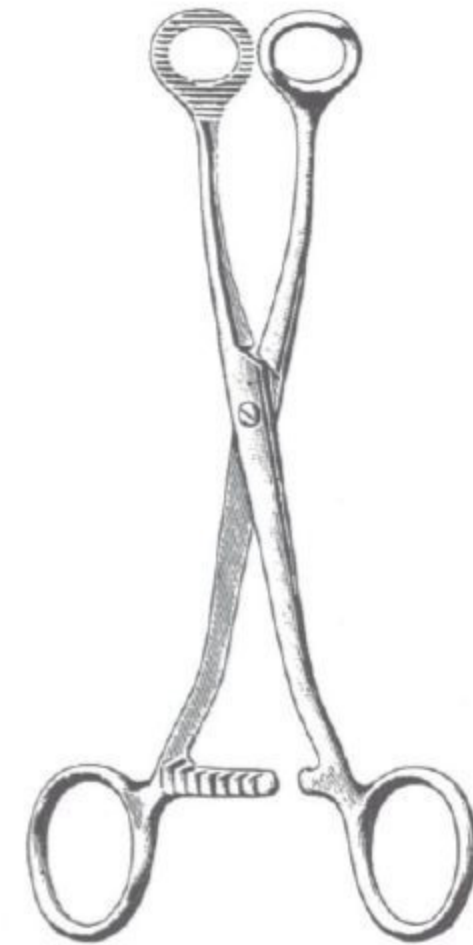

Collin
 19-5284-16
 16 cm/6¼"



Collin
 19-5285-19
 19 cm/7½"



19-5286-19
 19 cm/7½"



Young
 19-5287-17
 17 cm/6¾"



Guys
 19-5288-19
 19 cm/7½"

Finger Protectors



Lengenbeck
 19-5289-01 Ø 22.0 mm
 19-5289-02 Ø 24.5 mm
 19-5289-03 Ø 26.5 mm

- EN** Tonsil
- DE** Mandel
- ES** Amígdala

Page 468 to 474





Luniatschek
 20-5351-18
 18 cm/7"



Luniatschek
 20-5352-18
 18 cm/7"

Gauze Packers



Trelat
 20-5353-23
 23 cm/9"



Claus
 20-5354-23
 23 cm/9"



Hurd
 20-5355-24
 24 cm/9½"



Hurd
 20-5356-21
 21 cm/8¼"



Nager
 20-5357-24
 24 cm/9½"



Falk
 20-5358-24
 24 cm/9½"



Falk
 20-5359-24
 24 cm/9½"



Claus-Eicken
 20-5360-23
 23 cm/9"

Ligature Carrier



Roeder
 20-5361-26
 26 cm/10¼"

Cleft Palate knives and tonsil knives ● EN
 Nadeln zur gaumennaht, Tonsillennadeln ● DE
 Agujas para suturas del paladar, Agujas para suturas de amígdalas ● ES



20-5362-17
 17.5 cm/6⁷/₈"



Fischer
 20-5363-22
 22.5 cm/8⁷/₈"



Douglas
 20-5364-21
 21 cm/8¹/₄"



Abraham
 20-5365-21
 21 cm/8¹/₄"



Bruenings
 20-5366-23
 23 cm/9"



Abraham
 20-5367-19
 19 cm/7¹/₂"



Canfield
 20-5368-21
 21 cm/8¹/₄"



Negus Knot Tier and Pusher
 20-5369-20
 20cm/8"



Molison Pillar
 double ended
 20-5370-21
 21cm/8 ¼"



Gwynee Evans Dissector
 double ended
 20-5371-06
 6mm, 20cm/8"
 20-5372-06
 8mm, 20cm/8"



Hurd
 20-5373-22
 22.5 cm/8 7/8"



Yankauer
 20-5374-21
 21 cm/8 ¼"



Luniatschek
 20-5375-19
 19 cm/7 ½"



Henke
 23 cm/9"



20-5376-01



20-5376-02



Nager
 20-5377-23
 23 cm/9"



Wide
 20-5378-18 18 mm
 20-5378-20 20 mm
 20-5378-22 22 mm

Love
 23 cm/9"



Haslinger
 20-5379-16



Hofer
 20-5380-24
 24 cm/9 ½"

Tonsil Seizing Forceps ● EN
 Tonsillenzangen ● DE
 Pinzas para coger las amígdalas ● ES



Museux
 Straight
 20-5381-20
 20 cm/8"

Curved
 20-5382-20
 20 cm/8"



Ballenger
 20-5383-21
 21.5 cm/8½"



White
 20-5384-18 18 cm/7"
 20-5384-23 23 cm/9"



Marschik Kroni
 20-5385-20
 20.5 cm/8"



Colver
 Straight
 20-5386-19
 19 cm/7½"

Curved
 20-5387-19
 19 cm/7½"



Blohmke
 20-5388-20
 20 cm/8"



Eves
 20-5389-28
 28 cm/11"



Eves
 20-5390-28
 28 cm/11"



Bruenings
 20-5391-28
 28 cm/11"



With 1 Straight Tip

Brown
 20-5392-00



With 1 Straight Tip

Tyding
 20-5393-00

- Tonsillectomes ● — EN
- Tonsillotome ● — DE
- Amigdalótomos ● — ES



Sluder-Ballenger
 Complete, With 3 Tips
 20-5394-00

Tonsil Haemostats



Corwin
 20-5395-14
 14 cm/5½"

Tonsil Punch Forceps



- 20-5396-13 13 mm Ø
- 20-5396-15 15 mm Ø
- 20-5396-17 17 mm Ø

Hartmann

Denis Browne
 Tonsil Forceps
 20-5397-20
 20cm/8"

Luc Forceps
 20-5398-20 Small
 20-5399-20 Medium
 20-5400-20 Large
 20cm/8"



- 20-5401-06 Dia 6mm
- 20-5401-08 Dia 8mm
- 20-5401-10 Dia 10mm
- 20-5401-12 Dia 12mm
- 20-5401-14 Dia 14mm
- 20-5401-16 Dia 16mm
- 20-5401-18 Dia 18mm
- 20-5401-20 Dia 20mm
- 20-5401-22 Dia 22mm
- 20-5401-24 Dia 24mm
- 20-5401-26 Dia 26mm
- 20-5401-28 Dia 28mm
- 20-5401-30 Dia 30mm

Laryngeal Mirror
 with metal handle
 22cm/8 3/4"



Waugh Dissecting Forcep
 20-5402-20
 1 x 2 teeth
 20cm/8"



Waugh Dissecting Forcep
 20-5403-20
 serrated
 20cm/8"



Metzenbaum Scissor Cvd.
 20-5404-18
 18cm/7"

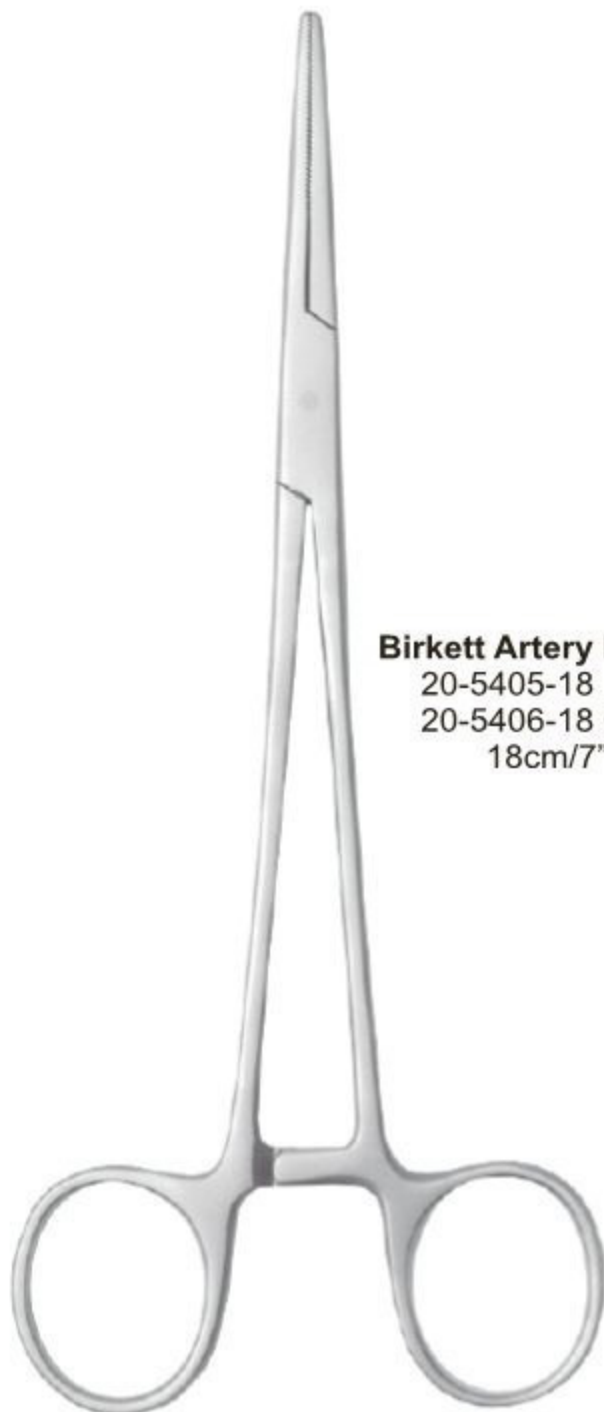

Birkett Artery Forcep
 20-5405-18 Str.
 20-5406-18 Cvd.
 18cm/7"

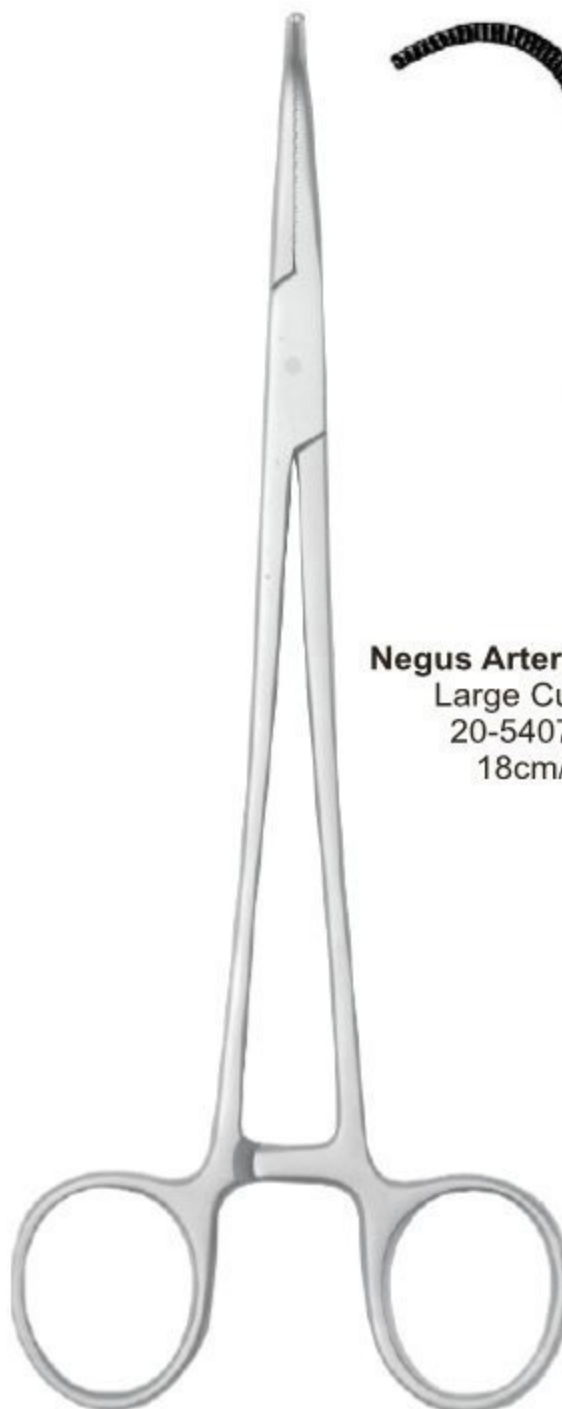

Negus Artery Forcep
 Large Curved
 20-5407-18
 18cm/7"

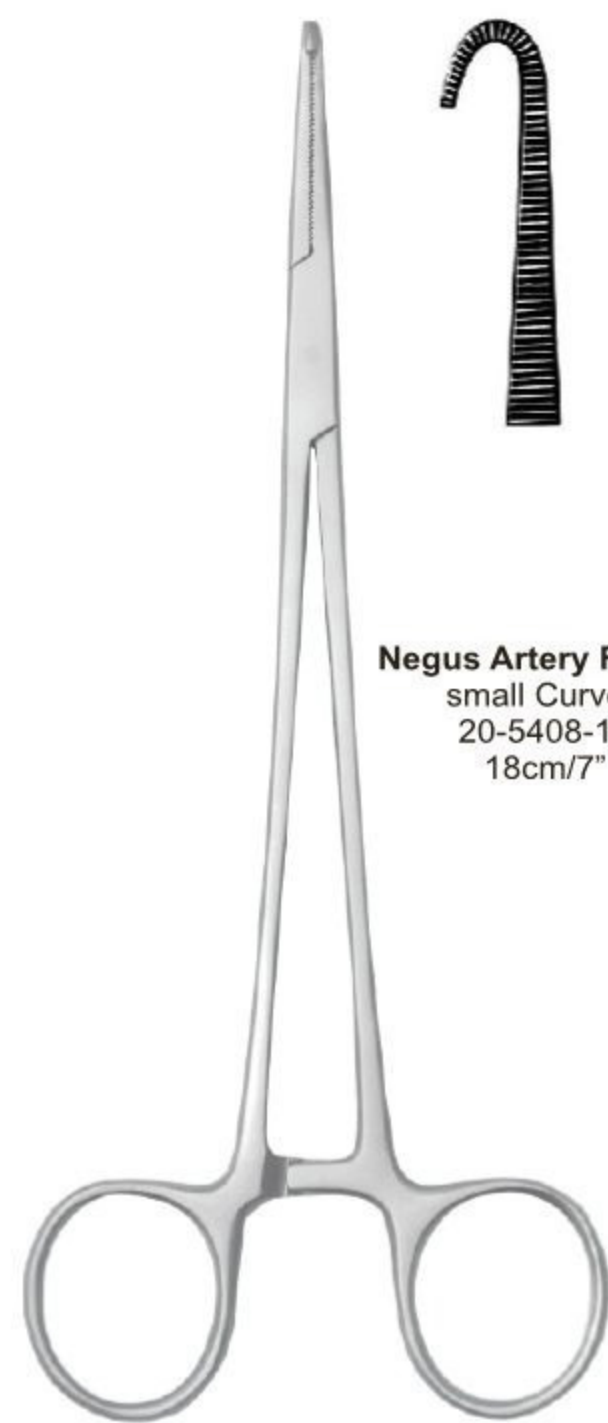

Negus Artery Forcep
 small Curved
 20-5408-18
 18cm/7"

- EN** Tracheotomy
- DE** Tracheotomie
- ES** Traqueotomía

Page 475 to 479





Laborde
 21-5551-13 13 cm/5"
 21-5551-15 15 cm/6"



Trousseau (Adult)
 21-5552-14
 14 cm/5½"



Trousseau (Child)
 21-5553-13
 13 cm/5"

Hooks



Bose
 21-5554-07
 7 cm/2¾"

Left



21-5555-16

Right



21-5556-16

Sharp

Bose
 16 cm/6¼"

Thyroid Gland Retractor



Schoenborn
 21-5557-21
 21 cm/8¼"

Trachea Trocars



Uckerman
 21-5558-08 08 mm Ø
 21-5558-10 10 mm Ø
 13 cm/5"

International scale

Fig.	0	1	2	3	4	5	6	7	8	9
Diameter	④	⑤	⑥	⑦	⑧	⑨	⑩	⑪	⑫	⑬mm
Length of outer tube N	45	50	55	60	65	70	75	80	85	90mm



LUER

Fig	mmØ	45-90mm	95mm	105mm
0	4	21-5559-04		
1	5	21-5559-05		
2	6	21-5559-06		
3	7	21-5559-07		
4	8	21-5559-08	21-5560-08	21-5561-08
5	9	21-5559-09	21-5560-09	21-5561-09
6	10	21-5559-10	21-5560-10	21-5561-10
7	11	21-5559-11	21-5560-11	21-5561-11
8	12	21-5559-12	21-5560-12	21-5561-12
9	13	21-5559-13	21-5560-13	21-5561-13



CHEVALIER-JACKSON

Fig	mmØ	45-90mm
0	4	21-5562-04
1	5	21-5562-05
2	6	21-5562-06
3	7	21-5562-07
4	8	21-5562-08
5	9	21-5562-09
6	10	21-5562-10
7	11	21-5562-11
8	12	21-5562-12
9	13	21-5562-13

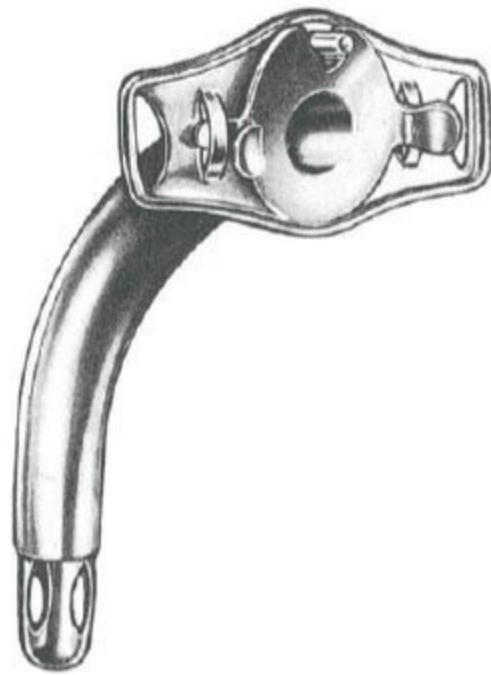

KRISHABER

Fig	mm	
0	4	21-5563-04
1	5	21-5563-05
2	6	21-5563-06
3	7	21-5563-07
4	8	21-5563-08
5	9	21-5563-09
6	10	21-5563-10
7	11	21-5563-11
8	12	21-5563-12



KRISHABER-LUER

Fig	mm	
0	4	21-5564-04
1	5	21-5564-05
2	6	21-5564-06
3	7	21-5564-07
4	8	21-5564-08
5	9	21-5564-09
6	10	21-5564-10
7	11	21-5564-11
8	12	21-5564-12

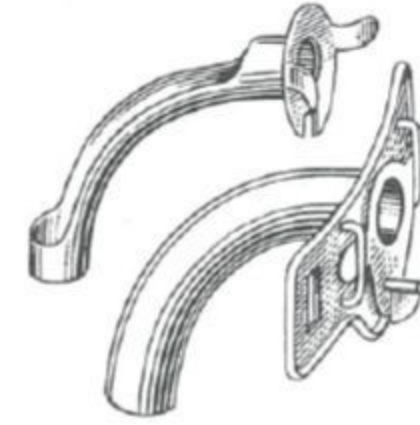

PARKER

Fig	F.G	
1	16	21-5565-16
2	18	21-5565-18
3	20	21-5565-20
4	22	21-5565-22
5	24	21-5565-24
6	26	21-5565-26
7	28	21-5565-28
8	30	21-5565-30
9	32	21-5565-32

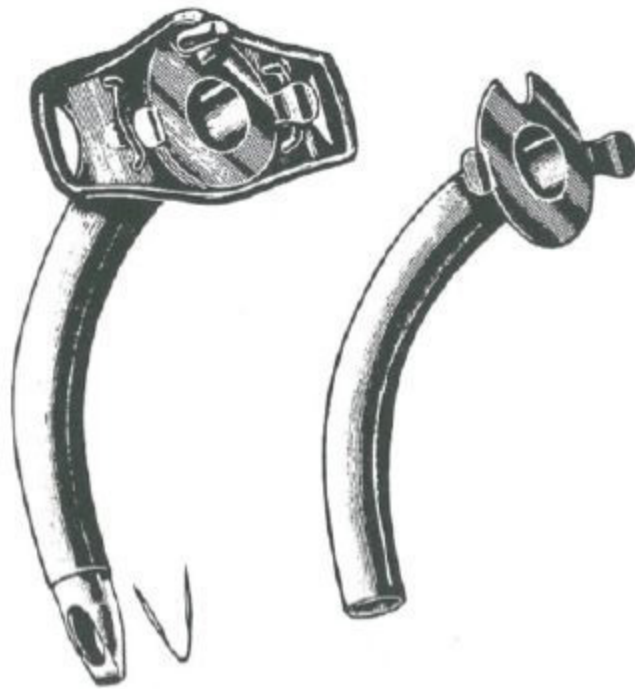

COLLIN

Fig	mm	
0	4	21-5566-04
1	5	21-5566-05
2	6	21-5566-06
3	7	21-5566-07
4	8	21-5566-08
5	9	21-5566-09
6	10	21-5566-10
7	11	21-5566-11
8	12	21-5566-12



FULLER

Fig	F.G	
1	18	21-5567-18
2	20	21-5567-20
3	22	21-5567-22
4	24	21-5567-24
5	26	21-5567-26
6	28	21-5567-28
7	30	21-5567-30
8	32	21-5567-32

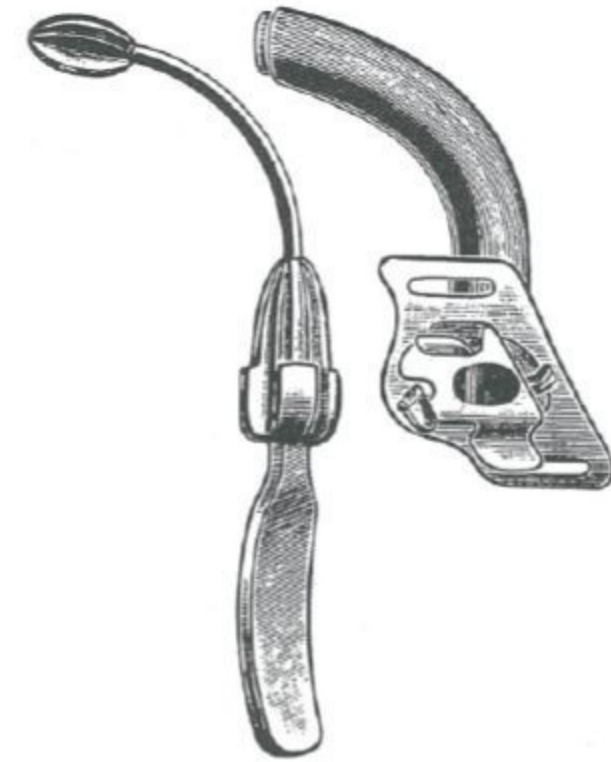

CUBLEY

Fig	F.G	
1	16	21-5568-16
2	18	21-5568-18
3	20	21-5568-20
4	22	21-5568-22
5	24	21-5568-24
6	26	21-5568-26
7	28	21-5568-28
8	30	21-5568-30
9	32	21-5568-32

Trachea Tubes ● EN
 Tracheal-Kanülen ● DE
 Cánulas traqueales ● ES

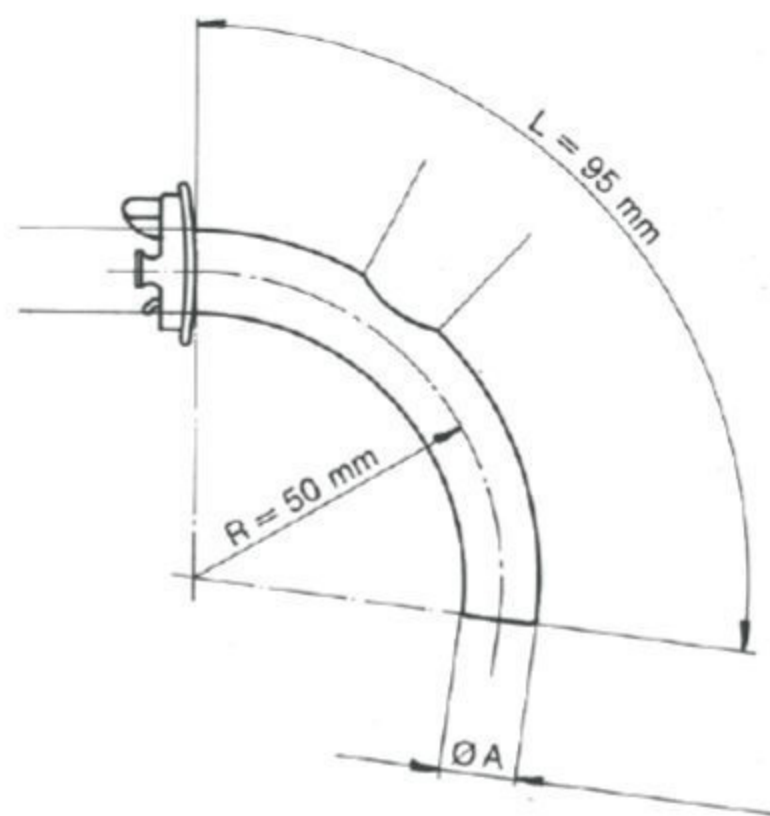
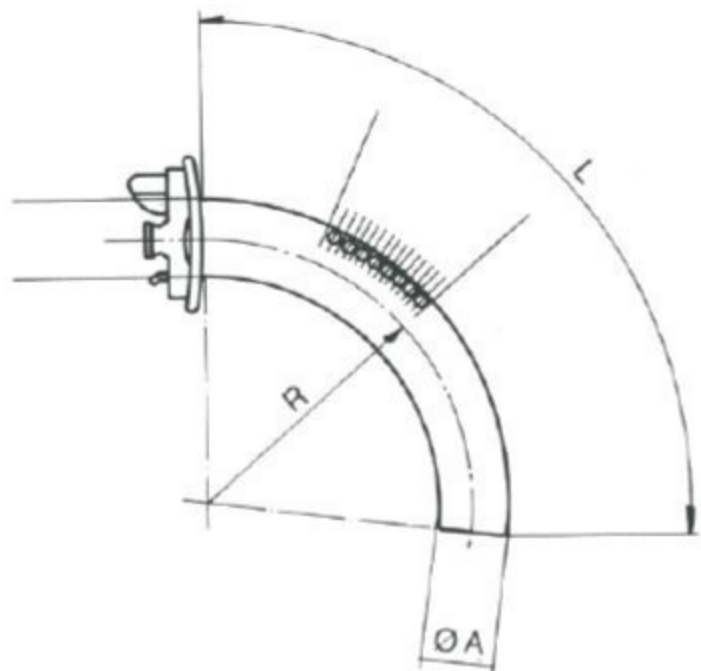
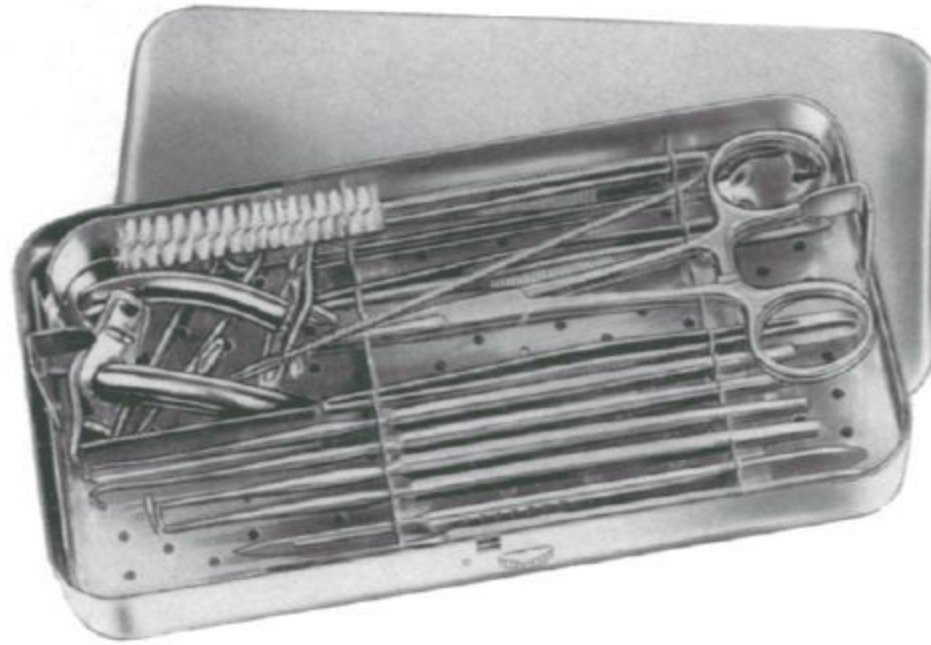

Fig		ØA	L	R
0	21-5569-08	8	65	36.5
1	21-5569-09	9	70	29
2	21-5569-10	10	75	40.5
3	21-5569-11	11	80	41.5
4	21-5569-12	12	85	43
5	21-5569-13	13	90	47.5

Fig		ØA	L	R
0	21-5570-08	8	95	50
1	21-5570-09	9	95	50
2	21-5570-10	10	95	50
3	21-5570-11	11	95	50
4	21-5570-12	12	95	50
5	21-5570-13	13	95	50



200 x 105 x 30mm

TRACHEOTOMY SET

21-5571-00

complete in metal case, consisting of:

- 1 Handle with 1 blade, Fig. 20
- 1 Handle with 1 blade, Fig. 23
- 1 Thumb forceps, 13.0cm
- 1 Tissue forcep, 13.0cm 1 x 2 teeth
- 2 Pean Artery Forceps, 13.0cm
- 1 Grooved Director, 14.0cm
- 1 Trachea Dilator
- 2 Iterson Trachea Retractors, blunt
- 1 Bose Trachea Retractor, sharp left hand side
- 1 ditto, right hand side
- 1 Luer Trachea Tube, Standard
- 1 ditto
- 1 Cleaning Brush

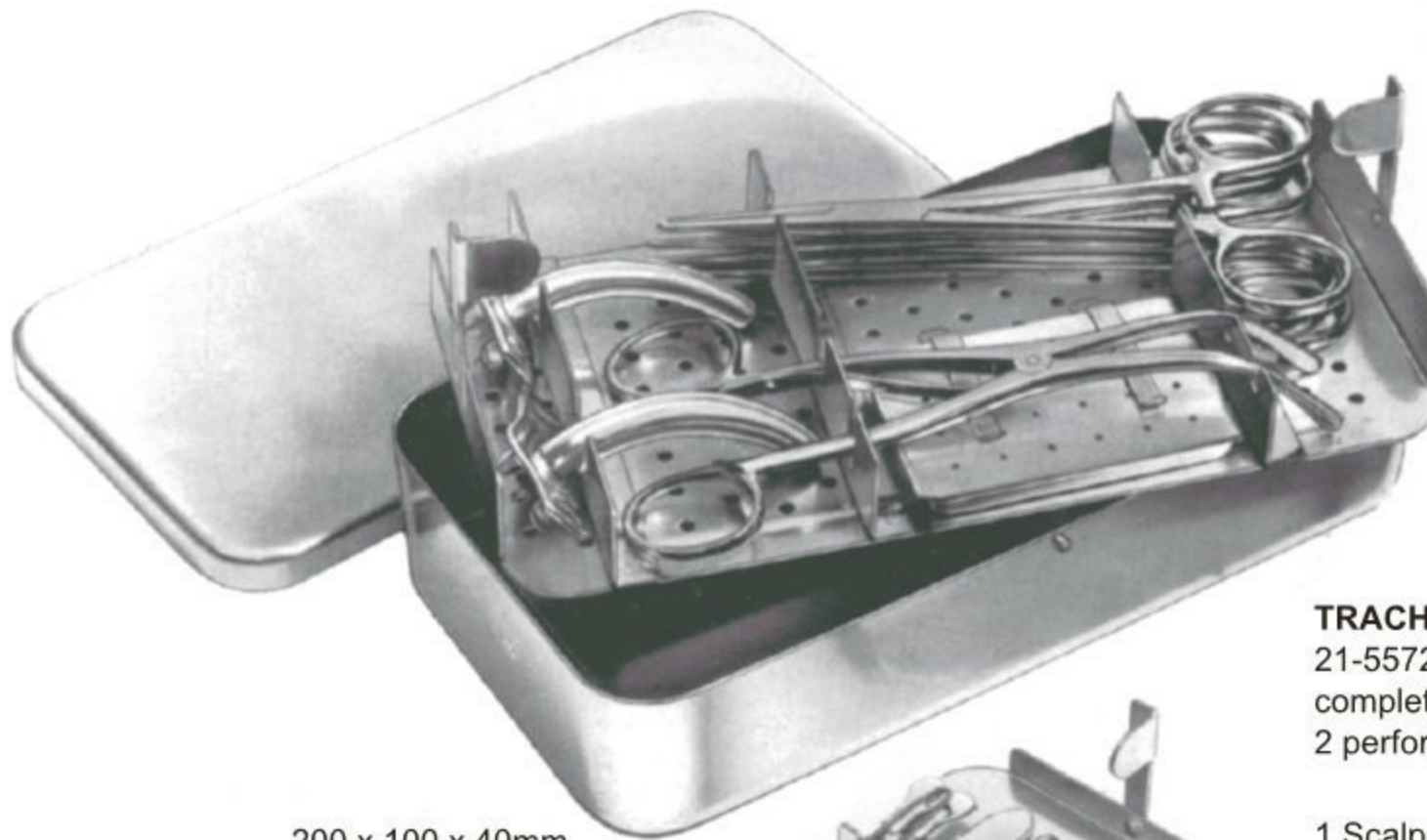

200 x 100 x 40mm

TRACHEOTOMY SET

21-5572-00

complete in metal case 200 x 100 x 40 mm, with 2 perforated trays of 18/8 s/s containing the following instruments:

- 1 Scalpel Handle No. 4, with blade No. 20
- 1 Scalpel Handle No. 4, with blade No. 23
- 3 Scalpel Blades, assorted, in perforated small case.
- 1 Small case for above Scalpel Blades
- 1 Dressing Forceps, serrated, 13.0cm
- 2 Tissue Forceps, 1 x 2 teeth, 13.0cm
- 4 Crile Artery Forceps, straight, 14.0cm
- 1 Grooved Director, 14.0cm
- 1 Trousseau Trachea Dilator, 14.0cm
- 2 Iterson Trachea Hooks, blunt
- 1 Bose Hook, sharp, left hand side, 16.0cm
- 1 ditto, right hand side, 16.0cm
- 1 Luer Trachea Tube, size 2.6mm diam. German Silver.
- 1 ditto, size 4.8mm diam, German Silver.
- 1 Cleaning Brush, 12mm diam. 26.0cm

- EN** Goitre
- DE** Kropfchirurgie
- ES** Bocio

Page 480



Scissors, Directors-Enucleators, Goitre Seizing Forceps, Muscular Clamp ● EN
 Schere, Directors-Enucleators, Struma ergriff Pinzetten, Muscular Clamp ● DE
 Tijeras, Directores Enucleators, pinzas bocio Aprovechando, Clamp Muscular ● ES

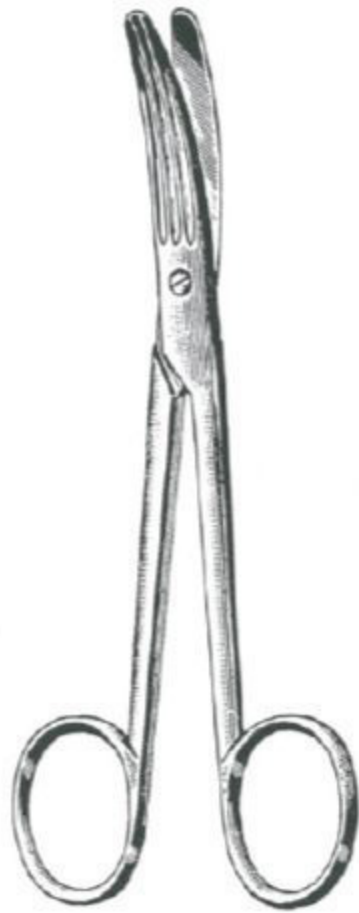

SCHOEMAKER
 22-5601-15 15.0cm

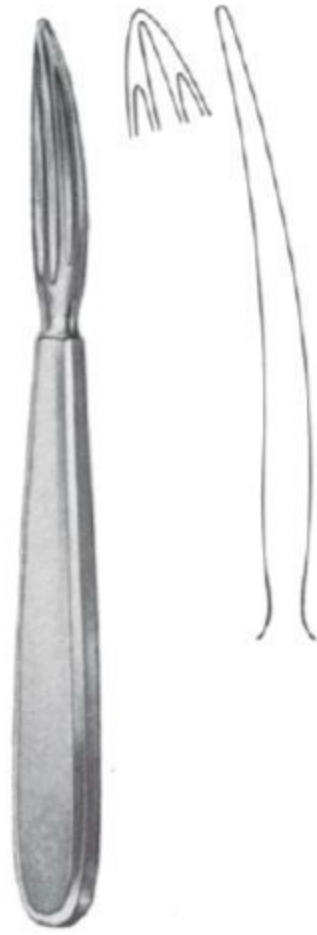

KOCHER
 22-5602-15 15.0cm
 22-5602-16 16.0cm

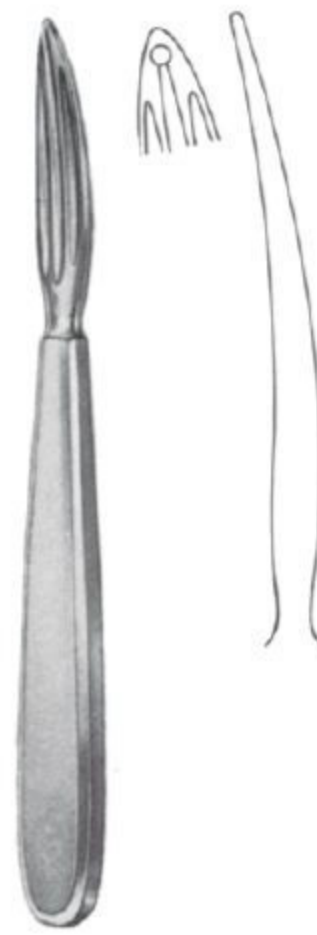

KOCHER
 22-5603-15 15.0cm
 22-5603-16 16.0cm

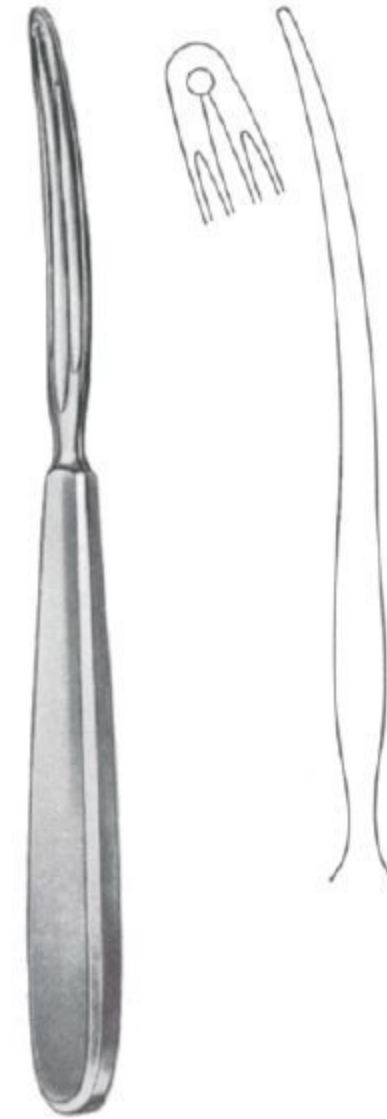

KOCHER
 22-5604-18 18.0cm



HOFMEISTER
 22-5605-21 21.0cm



LAHEY
 22-5606-15 15.0cm
 22-5606-20 20.0cm

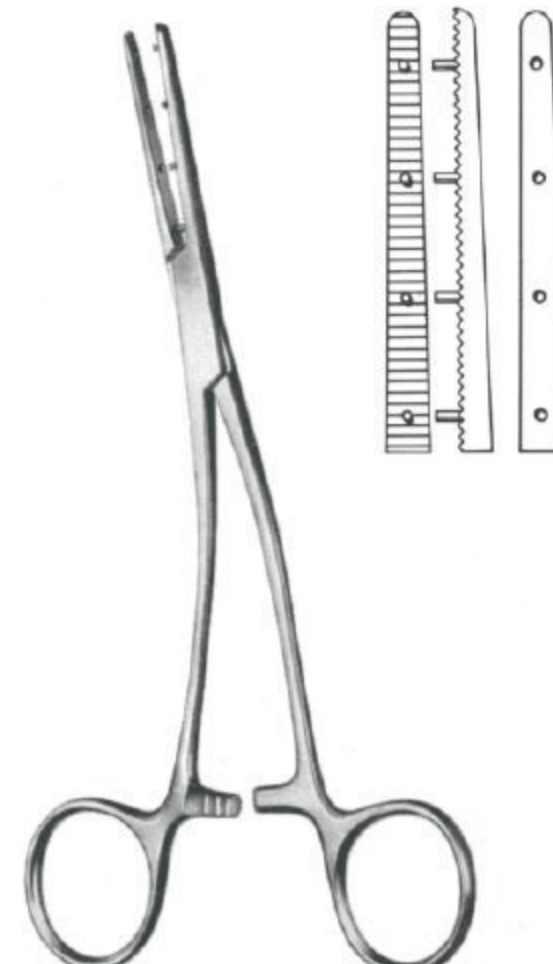

MASTIN
 22-5607-17 17.0cm

- EN** Dermatology
- DE** Dermatologie
- ES** Dermatología

Page 481 to 482



Comedone Extractors



Schamberg
 23-5751-10
 10 cm/4"



Unna
 23-5752-14
 14 cm/5½"



Unna
 23-5753-14
 14 cm/5½"



Sealfeld
 23-5754-10
 10 cm/4"



Saalfeld
 23-5755-14
 14 cm/5½"



Katsch
 23-5756-14
 14 cm/5½"



Hebra
 23-5757-18
 18 cm/7"

Skin Curettes



Piffard
 14.5cm/5¾"



Fig. 1 23-5758-01



Fig. 2 23-5758-02



Fig. 3 23-5758-03

Lupus Currettes, Scraper, Moncorps Knife and Cutaneous Hooks ● EN

Lupus Küretten, Schaber, Messer und Moncorps Kutane Hooks ● DE

Curetas lupus, raspador, cuchillos y ganchos Moncorps cutánea ● ES

Lupus Currettes

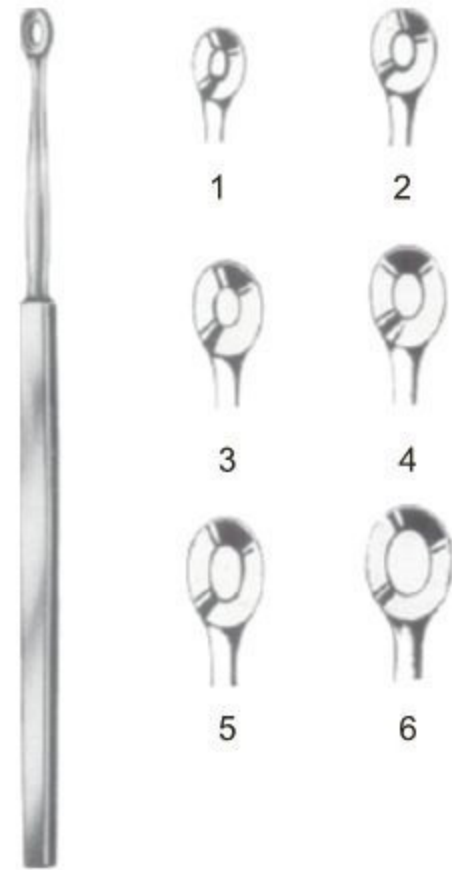

Wolff
14 cm/5½"

- Fig.
1 23-5759-01
2 23-5759-02
3 23-5759-03
4 23-5759-04
5 23-5759-05
6 23-5759-06

Lupus Currettes

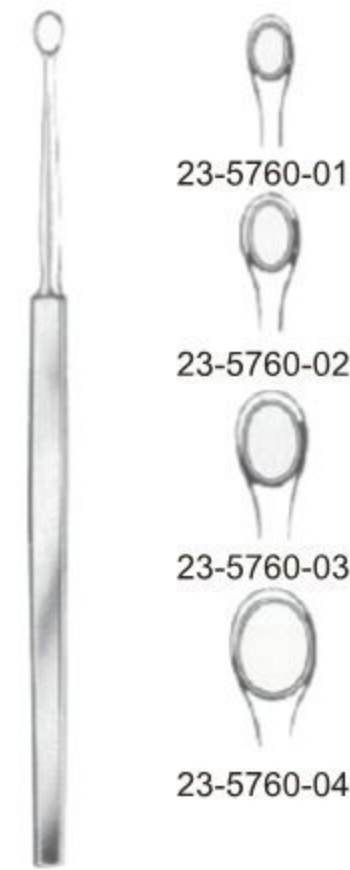

Fox
14 cm/5½"

Lupus Scraper



Vidal
23-5761-14
14 cm/5½"

Moncorps Knife



Moncorps
23-5762-14
14 cm/5½"



Gillies
Fig. 1 23-5763-01
Fig. 2 23-5763-02
18 cm/7"

Cutaneous Hook



Kilner
23-5764-15
15 cm/6"

- EN** Stomach, Intestine, Rectum
DE Magen, Darm, Mastdarm
ES Estómago, Intestinos, Recto

Page 483 to 504



- EN —● Tissue Seizing and Intestinal Atrauma Tissue Forceps
- DE —● Tissue Beschlagnahme und Darm Atrauma Tissue Zange
- ES —● Aprovechando el tejido intestinal y pinzas de tejido Atrauma



		Allis	
cm	in	4 : 5	5 : 6
15	6"	24-5801-15	24-5802-15
19	7½"		24-5802-19
23	9"		24-5802-23
25	10"		24-5802-25



		Baby-Allis	
24-5803-12	12 cm/4¾"		
24-5803-14	14 cm/5½"		



		Allis-Atrauma	
24-5804-16	16 cm/6¼"		
24-5804-20	20 cm/8"		
24-5804-25	25 cm/10"		
24-5804-30	30 cm/12"		



Allis-Adair
 24-5805-15
 15 cm/6"



Baby-Allis
 24-5806-15
 15 cm/6"



Lockwood-Allis
 24-5807-16 16 cm/6¼"
 24-5807-20 20 cm/8"



Thoms-Allis
 24-5808-20
 20 cm/8"

Tissue Seizing and Intestinal Atrauma Tissue Forceps ● EN
 Tissue Beschlagnahme und Darm Atrauma Tissue Zange ● DE
 Aprovechando el tejido intestinal y pinzas de tejido Atrauma ● ES

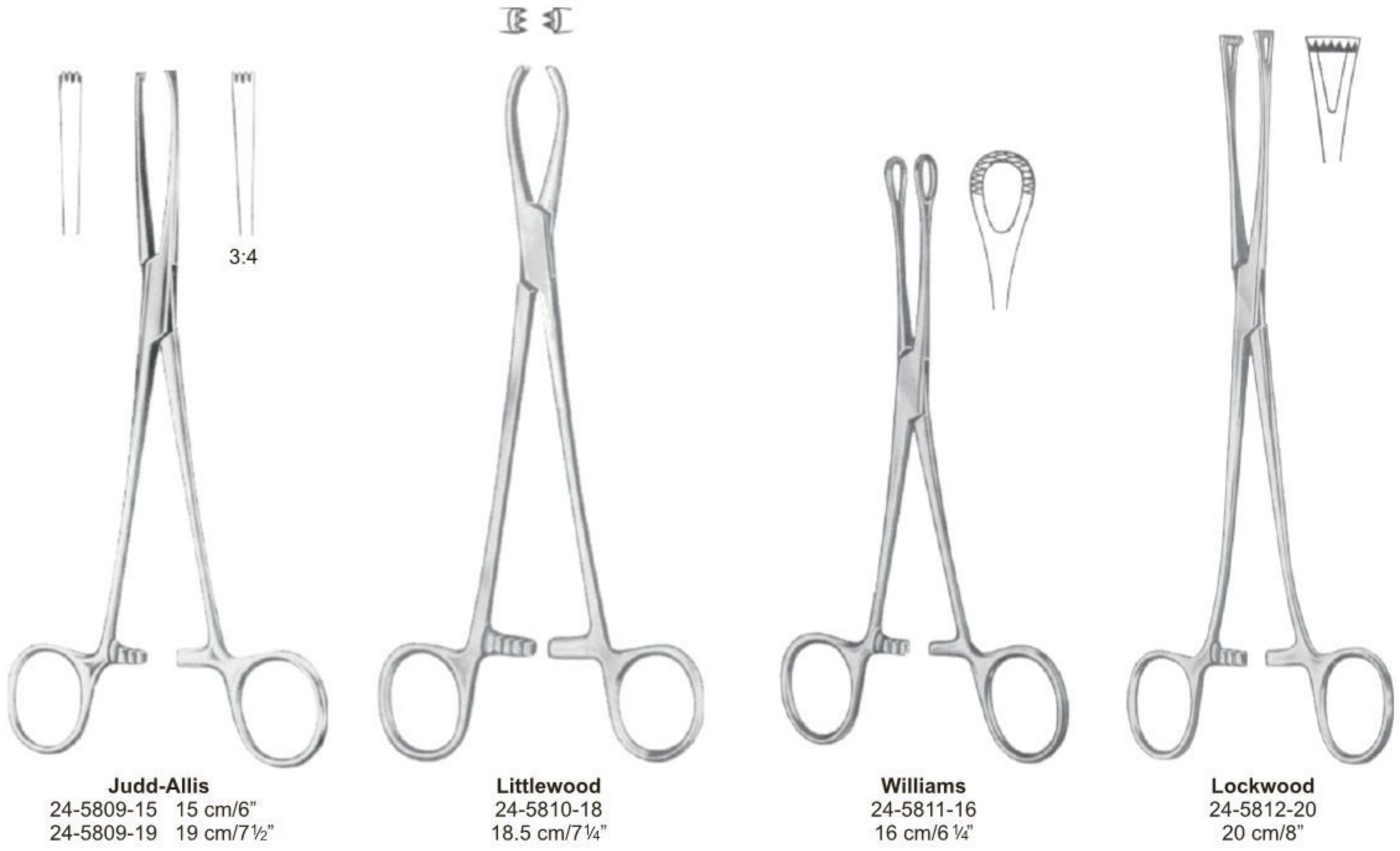

Judd-Allis
 24-5809-15 15 cm/6"
 24-5809-19 19 cm/7½"

Littlewood
 24-5810-18
 18.5 cm/7¼"

Williams
 24-5811-16
 16 cm/6¼"

Lockwood
 24-5812-20
 20 cm/8"

Atrauma



cm/in	Babcock-Atrauma	Babcock(Standard)	Baby-Babcock	Babcock
16 cm/6¼"	24-5813-16	24-5814-16	24-5815-16	24-5816-16
18 cm/7"		24-5814-18		
20 cm/8"	24-5813-20	24-5814-20		24-5816-20
24 cm/9½"		24-5814-24		

- EN —● Intestinal Tissue and Organ Grasping Forceps
- DE —● Gewebe- und organ-Faßzangen
- ES —● Pinzas para tejidos y órganos

Atrauma

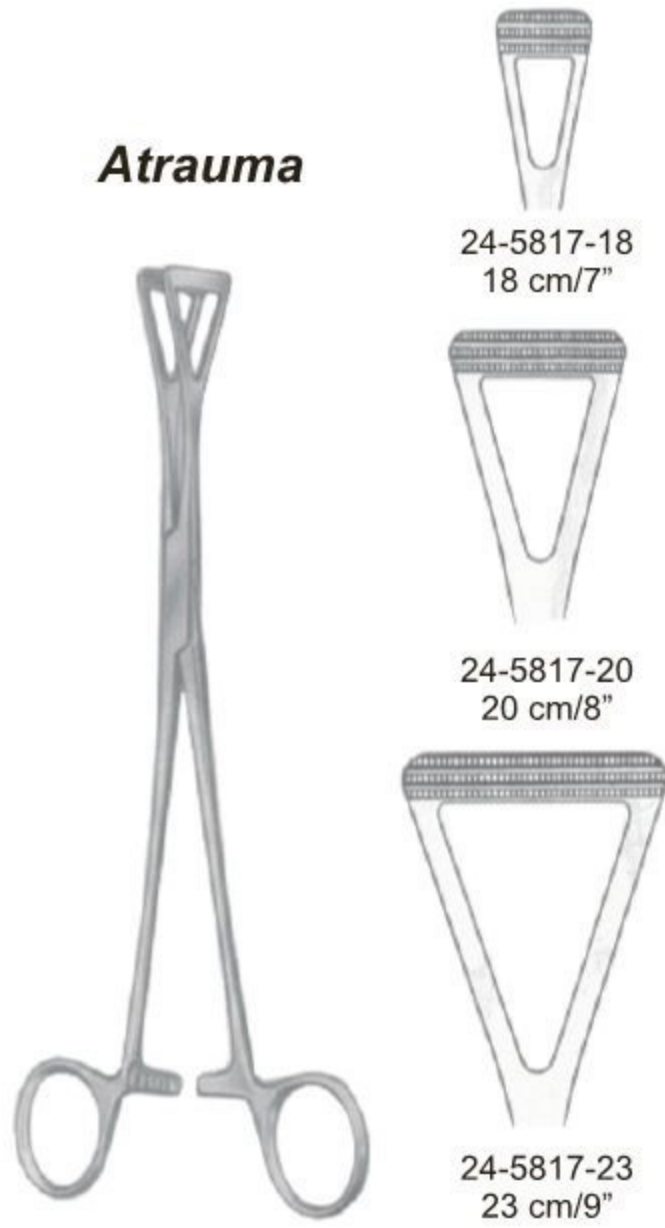

		Duval			
		cm	in		
24-5818-18		18	7"		
24-5818-20		20	8"	24-5819-20	
24-5818-23		23	9"	24-5819-23	

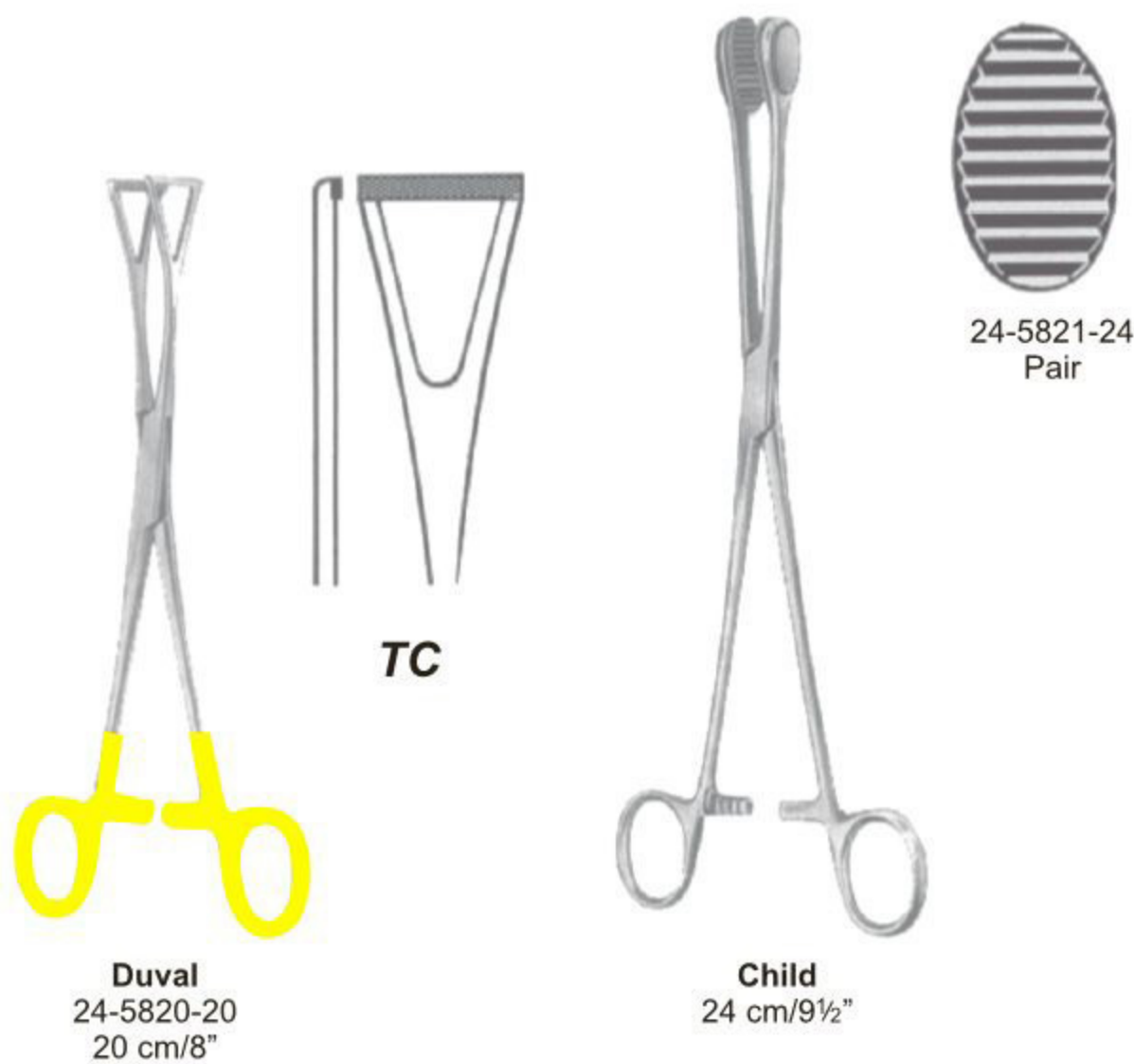

Atrauma

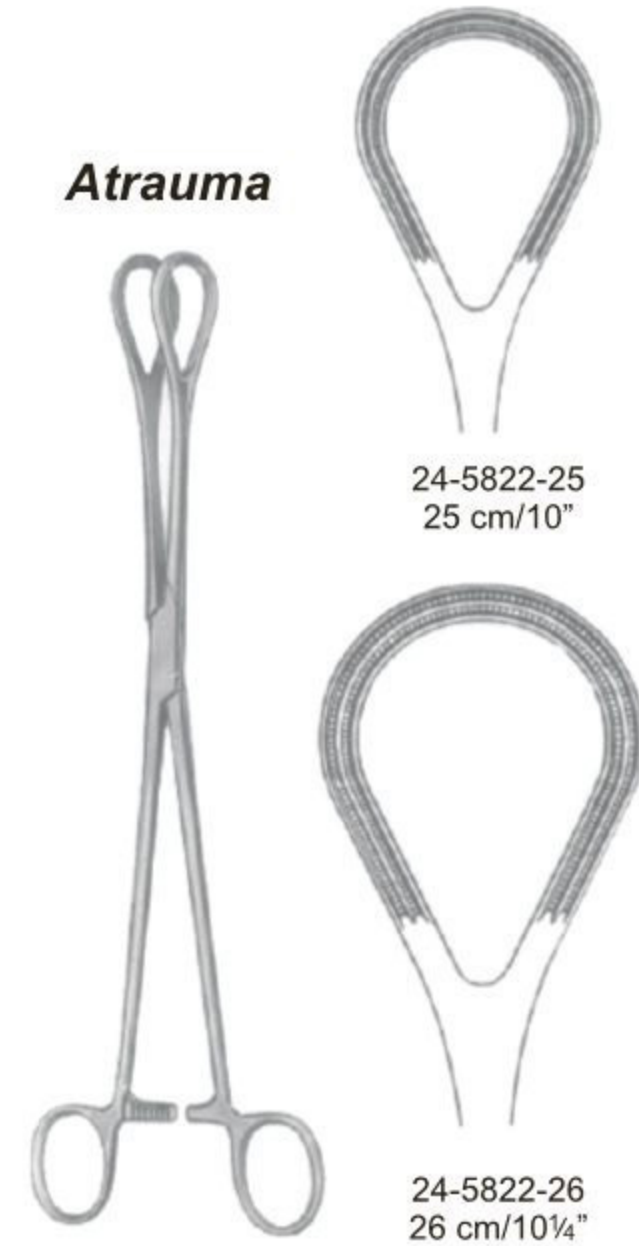

Intestinal Clamps Forceps ●— EN
 Darmklemmen ●— DE
 Pinzas-clamps intestinales ●— ES



Baby-Doyen
 Straight 24-5823-18 18 cm/7"
 Curved 24-5824-18 18 cm/7"

Doyen
 Straight 24-5825-21 21 cm/8 1/4
 24-5825-23 23 cm/9"
 Curved 24-5826-21 21 cm/8 1/4
 24-5826-23 23 cm/9"

Scudder
 24-5827-25 25 cm/10"



Doyen-Atrauma

Atrauma

Straight



Atrauma

Curved

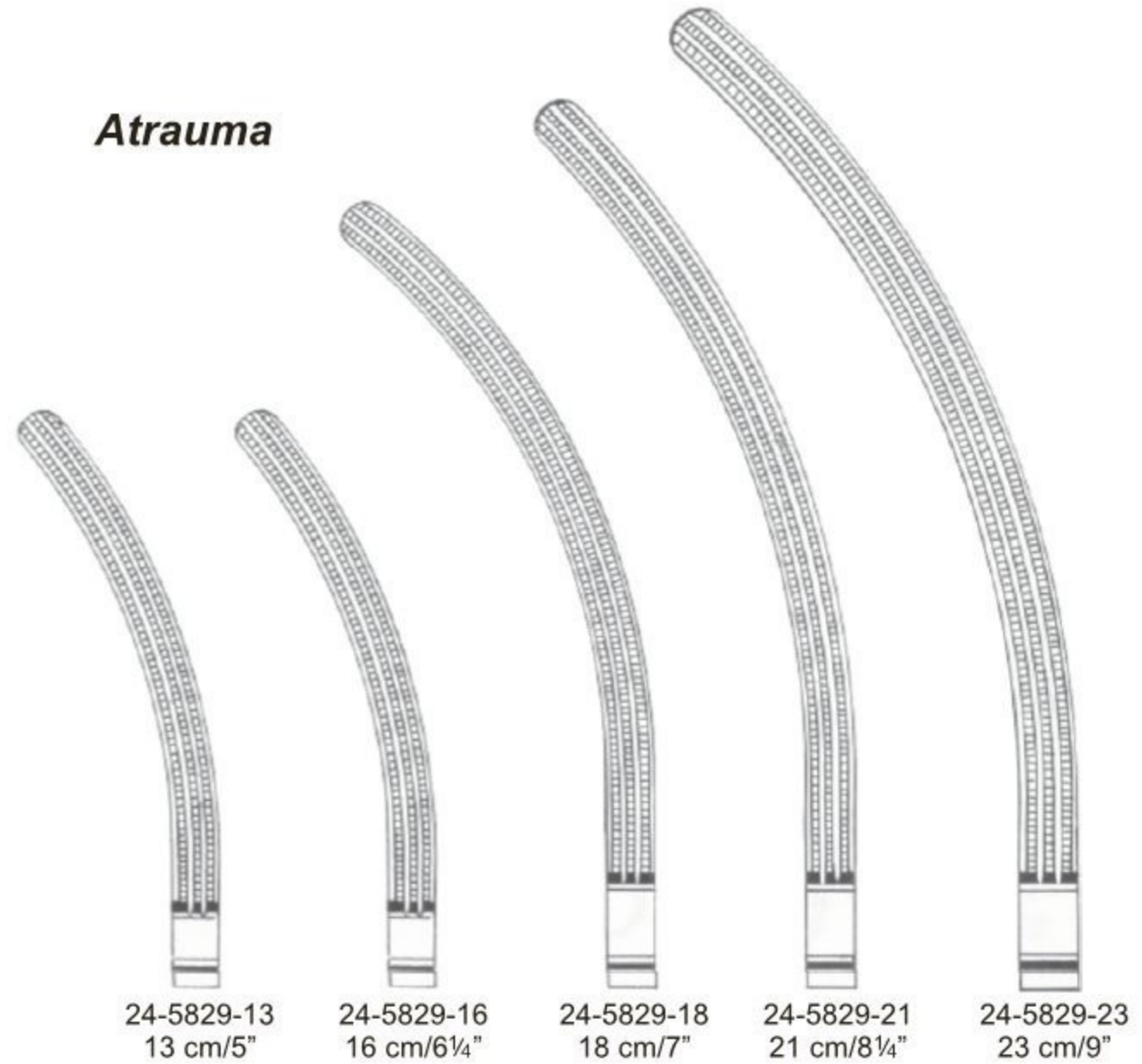

Intestinal Clamps Forceps ● EN
 Darmklemmen ● DE
 Pinzas-clamps intestinales ● ES



Mayo-Robson
 Mayo-Robson Atrauma

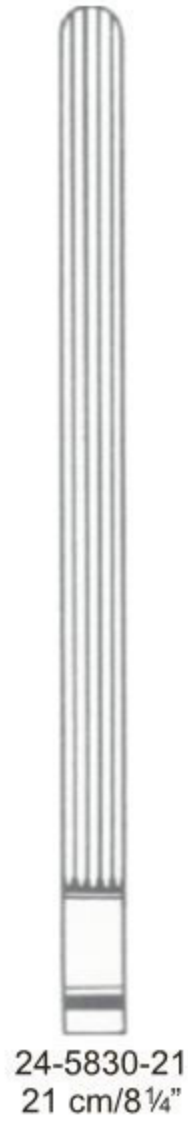

24-5830-21
 21 cm/8 1/4"



24-5831-21
 21 cm/8 1/4"

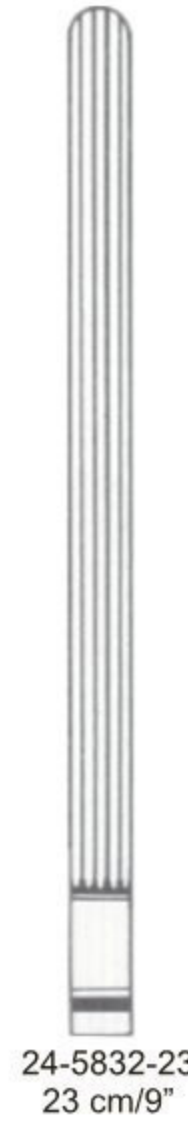

24-5832-23
 23 cm/9"



24-5833-23
 23 cm/9"

Atrauma



24-5834-25
 25 cm/10"



24-5835-25
 25 cm/10"

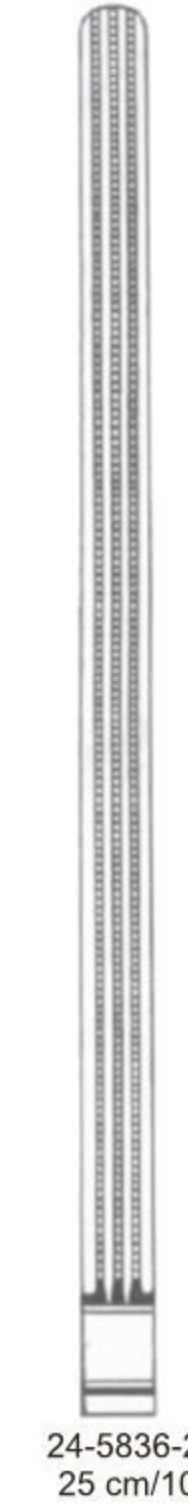

24-5836-25
 25 cm/10"



24-5837-25
 25 cm/10"



Resano
 24-5838-30
 30 cm/12"



Hayes

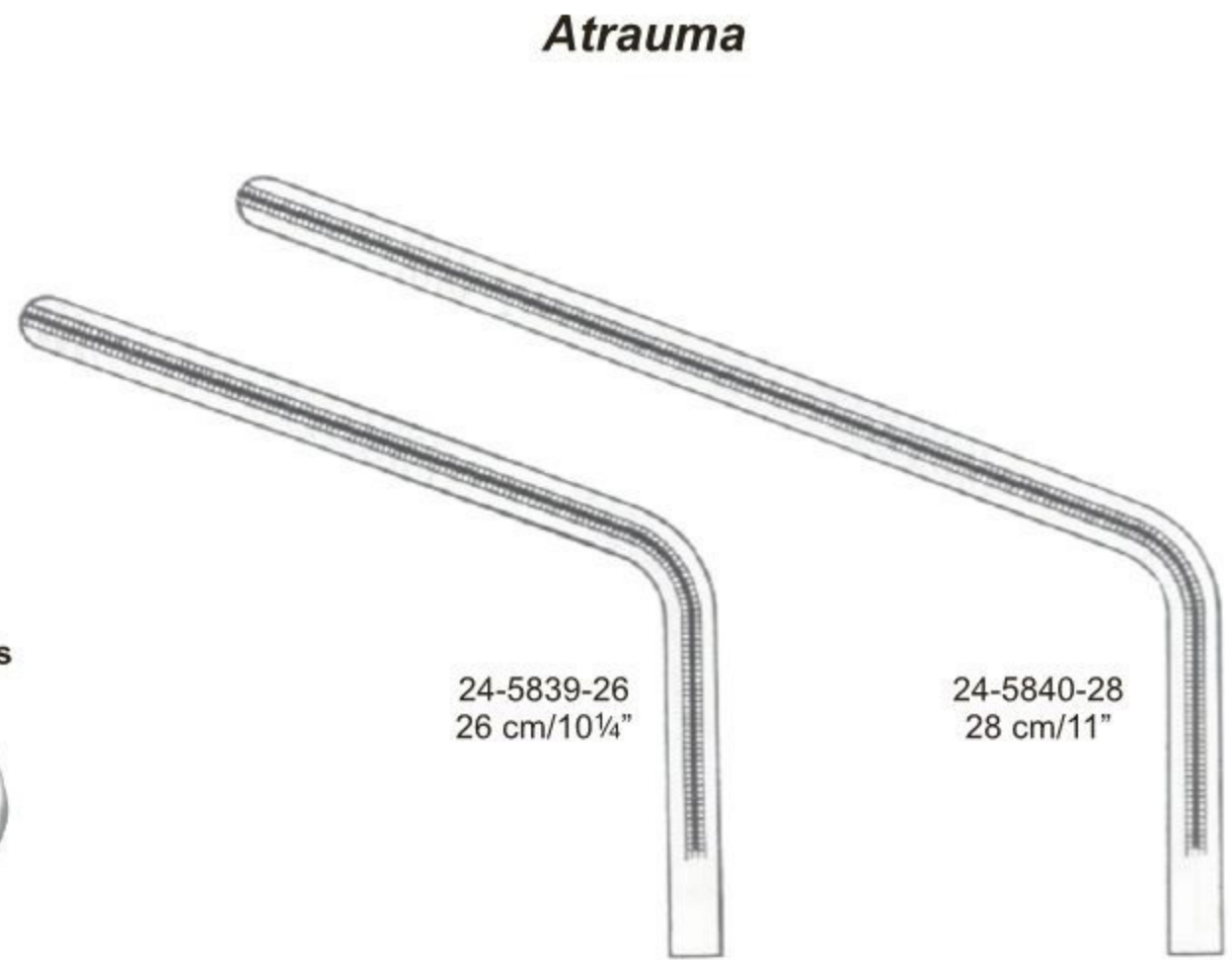

Atrauma

24-5839-26
 26 cm/10¼"

24-5840-28
 28 cm/11"



Fehland
 24-5841-24
 24 cm/9½"



Brunner
 24 cm/9½"

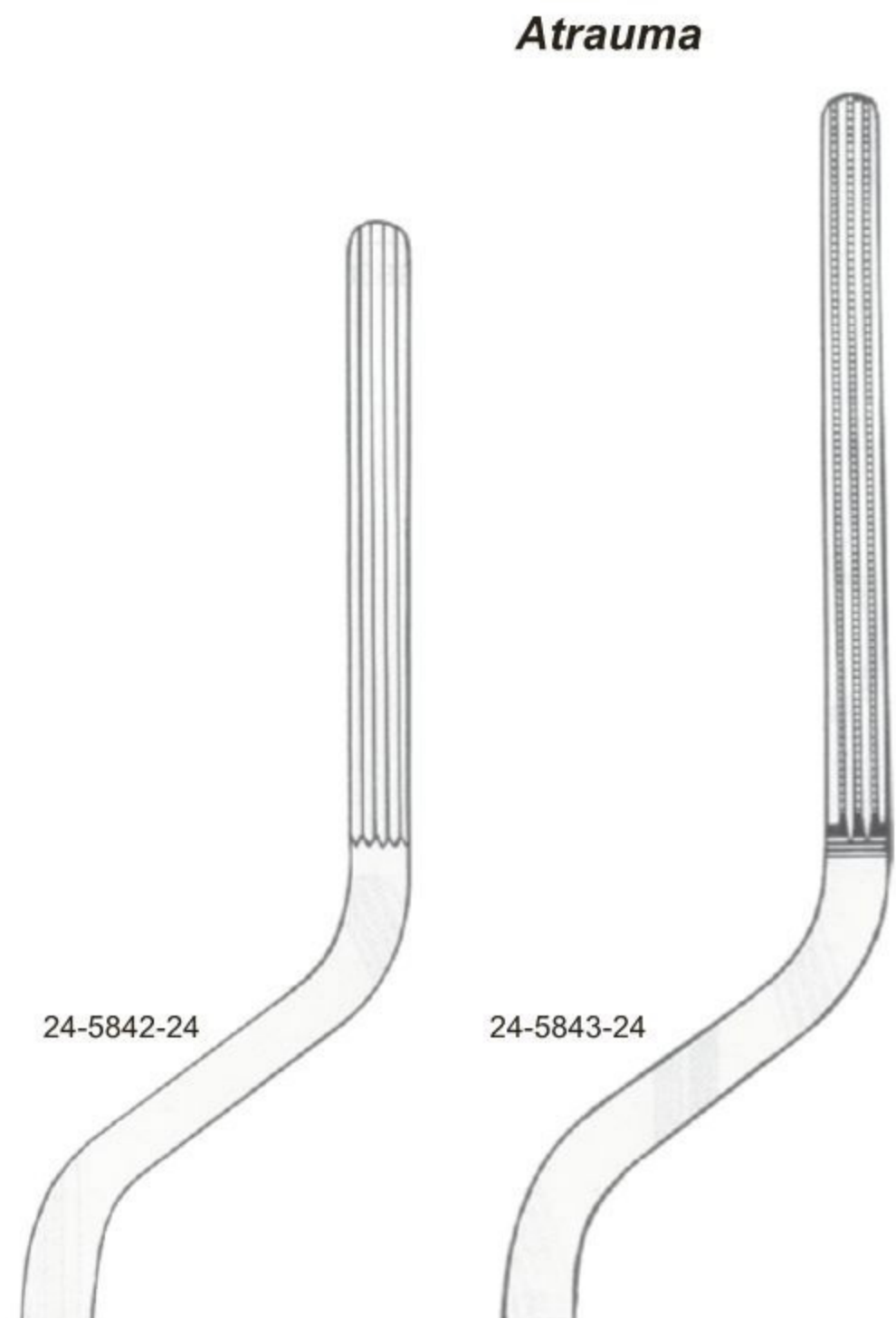

Atrauma

24-5842-24

24-5843-24

Intestinal Clamps Forceps ● EN
 Darmklemmen ● DE
 Pinzas-clamps intestinales ● ES



Straight **Baby-Kocher** Curved
 24-5844-13 24-5845-13
 13 cm/5" 13 cm/5"



Kocher



24-5846-22
 22 cm/8¾"



24-5846-25
 25 cm/10"



24-5846-28
 28 cm/11"



24-5847-22
 22 cm/8¾"



24-5847-25
 25 cm/10"



24-5847-28
 28 cm/11"

Atrauma



Kocher-Atrauma



24-5848-22
 22 cm/8 3/4"



24-5848-25
 25 cm/10"



24-5848-28
 28 cm/11"



24-5849-22
 22 cm/8 3/4"



24-5849-25
 25 cm/10"



24-5849-28
 28 cm/11"

Intestinal Clamps Forceps ●— EN
 Darmklemmen ●— DE
 Pinzas-clamps intestinales ●— ES

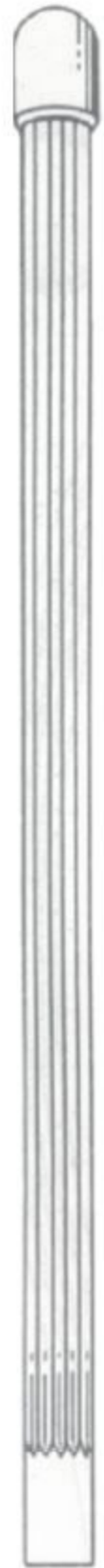

Straight
24-5851-25



Nussbaum
25 cm/10"



Curved
24-5852-25



Benson
24-5850-15
15.5 cm/6"

Pylorus spreader



Allen
24-5853-15 15.5 cm/6"
24-5853-20 20.0 cm/8"

Blindgut forceps



Kleinschmidt
24-5854-12
12 cm/4¾"



Payr
(Payr-Baby)

For children



24-5855-15
 15 cm/6"

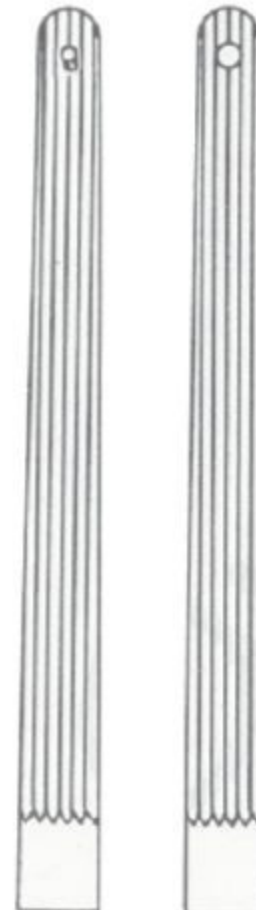

24-5856-21
 21 cm/8¼"

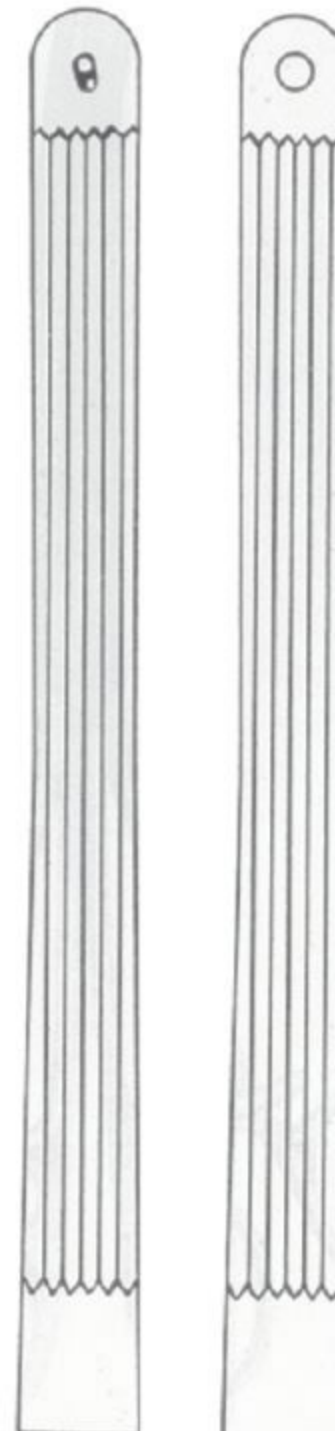

24-5857-29
 29 cm/11½"

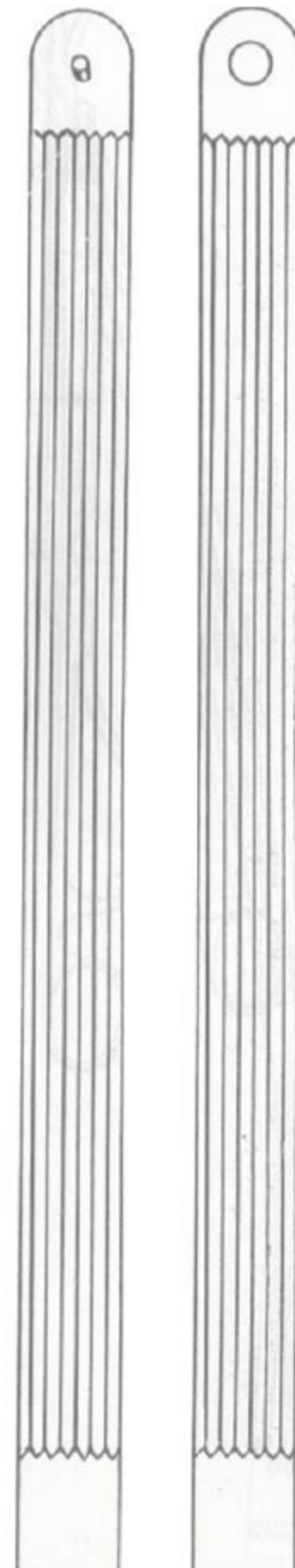

24-5858-35
 35 cm/13¾"



Lane
 30 cm/12"

Twin Clamps Forceps



Straight
 24-5859-30

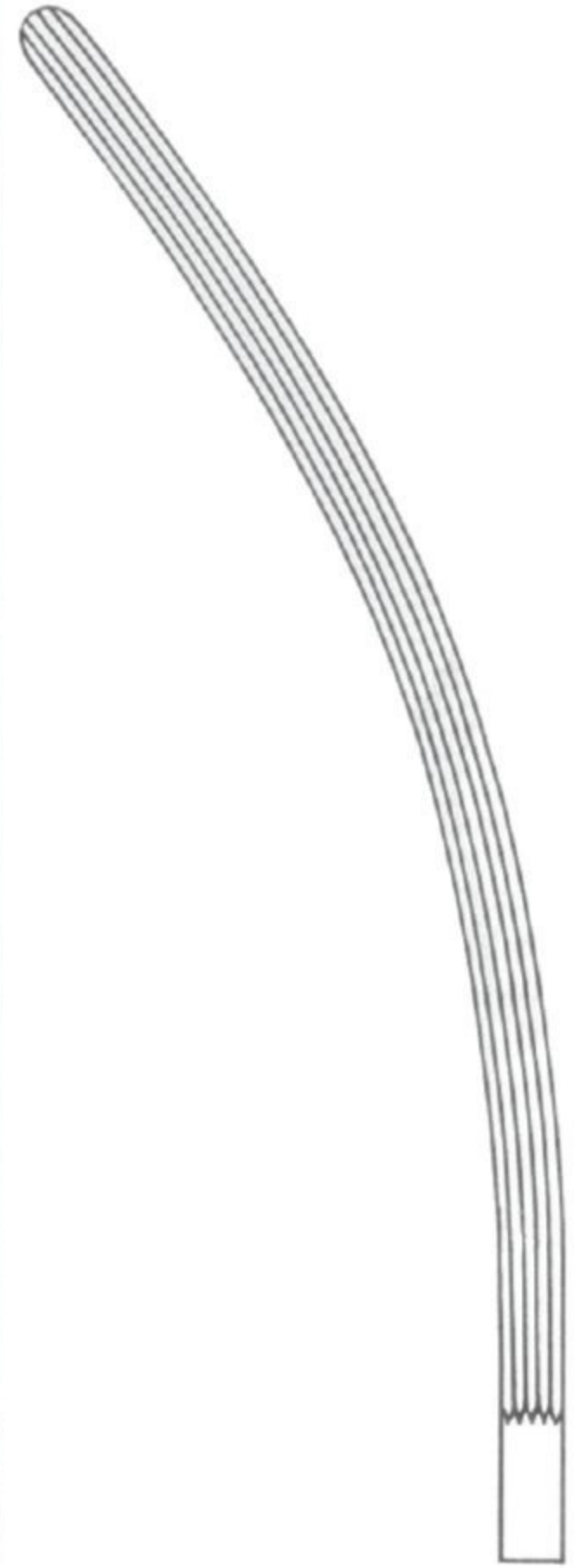

Curved
 24-5860-30

Atrauma



Stomach Clamps Forceps ● EN
 Magenklammen ● DE
 Pinzas-clamps estomacales ● ES

Intestinal and Stomach Twin Clamps



Haberer
 24-5865-36
 36 cm/14"



Straight
 24-5866-30

Nussbaum
 30 cm/12"

Curved
 24-5867-30



Czerny
 24-5868-22
 22 cm/8¾"



Pratt
 24-5869-20
 80 x 25 mm
 20.5 cm/8"



Sims
 25-08291-15

(Bodenhammer)
Sims
 24-5870-15
 15 cm/6"



Sims
 22 cm/8¾"

Length of Blades
 24-5871-06 60 mm
 24-5871-08 80 mm
 24-5871-12 125 mm
 24-5871-15 150 mm



Mathieu
 24-5872-19
 90 x 15 mm
 19.5 cm/7¾"

Rectal Speculas, Anal Retractors, Anusscopes ● EN

Mastdarm-spekula, -spreizer, Anoskop ● DE

Especulos rectales, Anoscopio ● ES



Barr
 24-5873-17
 17 cm/6¾"
 70 X 22 mm



Smith-Bule
 24-5874-15
 15 cm/6"

Anusscopes



Hirschmann
 Fig. 1 16 mm Ø x 65 mm 24-5875-01
 Fig. 2 19 mm Ø x 65 mm 24-5875-02
 Fig. 3 22 mm Ø x 65 mm 24-5875-03
 Fig. 4 25 mm Ø x 65 mm 24-5875-04



Bensaude
 Fig. 1 19 mm Ø x 70 mm 24-5876-01
 Fig. 2 22 mm Ø x 70 mm 24-5876-02

EN —● Anusopes, Proctoscopes and Sphincteroscopes

DE —● Spinkteroskope, Anuskope, Proktoskope

ES —● Esfinteroscopios, Anoscopios, Proctoscopios

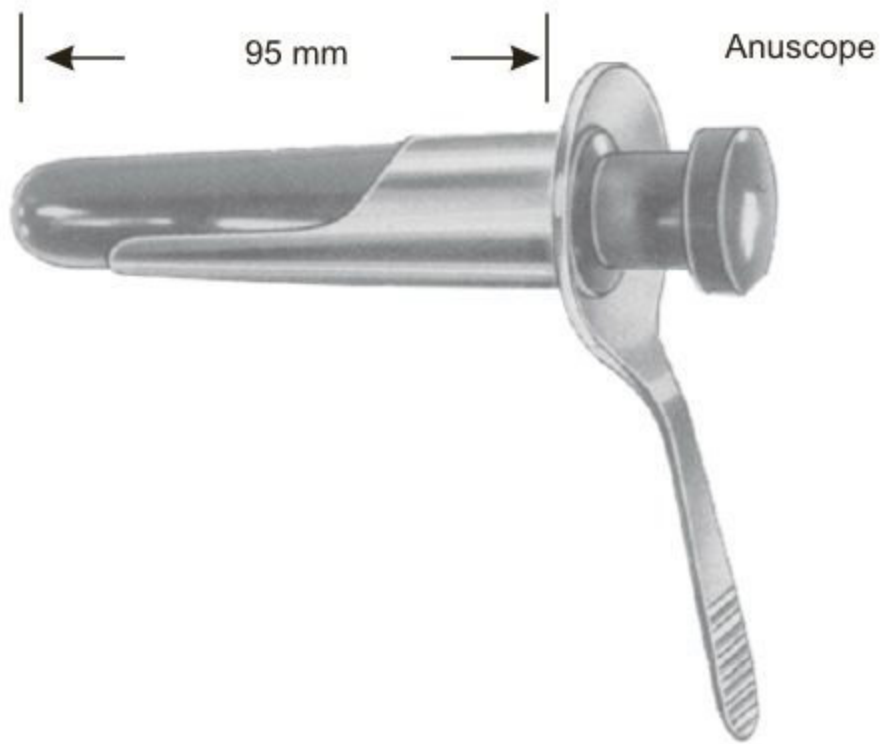

Ives-Fansler
 24-5877-22
 22 mm Ø

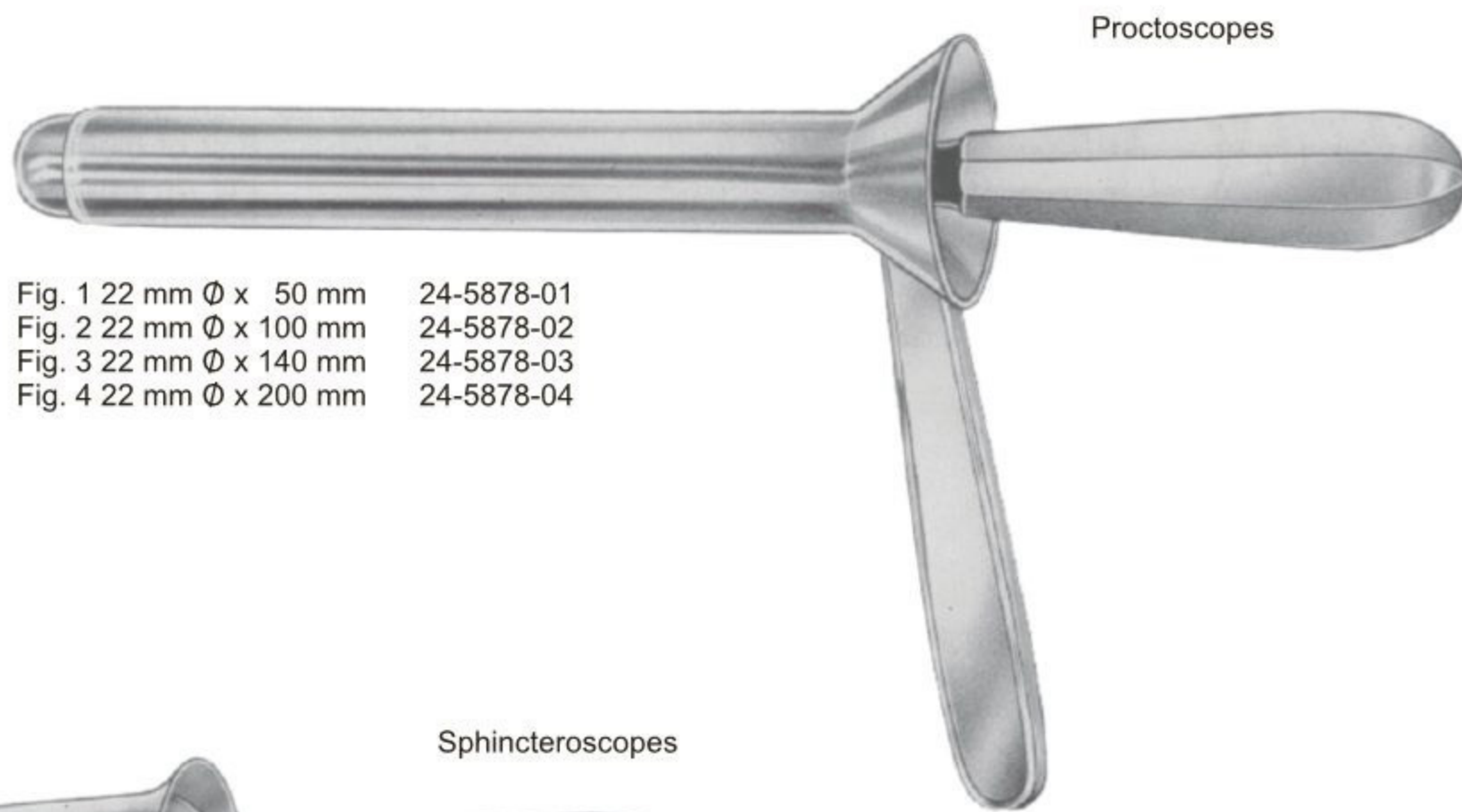

Fig. 1 22 mm Ø x 50 mm 24-5878-01
 Fig. 2 22 mm Ø x 100 mm 24-5878-02
 Fig. 3 22 mm Ø x 140 mm 24-5878-03
 Fig. 4 22 mm Ø x 200 mm 24-5878-04



Kelly

Kelly
 Fig. 1 21 mm Ø 50 mm 24-5879-01
 Fig. 2 27 mm Ø 50 mm 24-5879-02

Anal Retractors ●— EN
 Spreizer ●— DE
 Espéculos rectales ●— ES

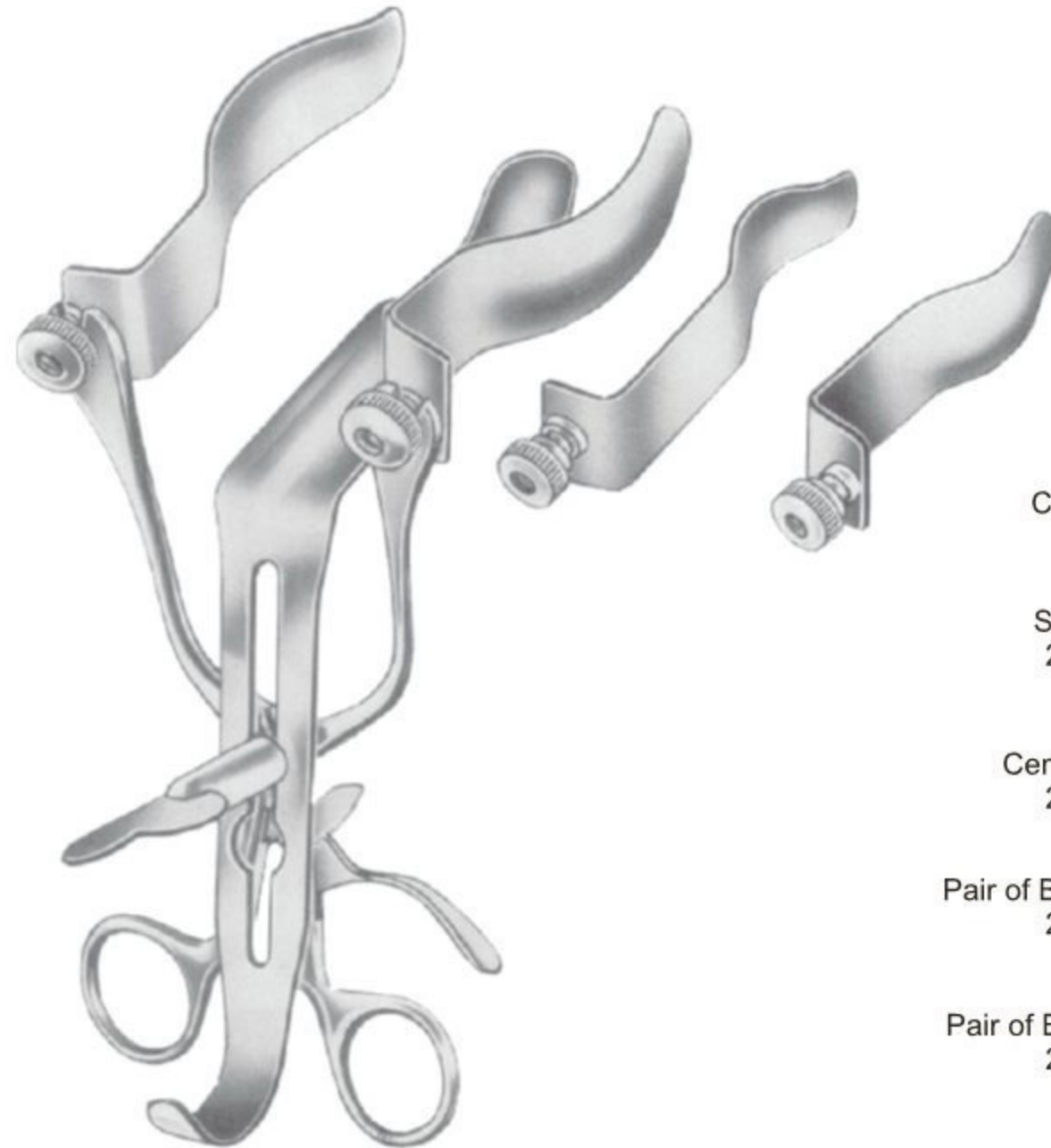

Consisting of:

Spreader only
 24-5880-01

Center Blade only
 24-5880-02

Pair of Blades Only 75 mm
 24-5880-03

Pair of Blades only 95 mm
 24-5880-04

Park
 24-5880-00
 14.5 cm/5¾"



Consisting of:

Spreader only
 24-5881-01

Pair of Blades only 95 mm
 24-5881-02

Park
 24-5881-00
 13 cm/5"

Length of Shaft

	1	2	3	4	cm	in	
	24-5882-28	24-5883-28	24-5884-28	24-5885-28	28	11	Yeoman
	24-5882-35	24-5883-35	24-5884-35	24-5885-35	35	13 ³ / ₄ "	
	24-5882-42	24-5883-42	24-5884-42	24-5885-42	42	16 ¹ / ₂ "	

Length of Shaft

Turnable

	Length of Shaft		Forceps Complete	Attachment Only	
	cm	in			
	33	13	24-5886-33	24-5890-33	Yeoman (Turrell) Handle Only 24-5894-00
	40	16	24-5886-40	24-5890-40	
	33	13	24-5887-33	24-5891-33	
	40	16	24-5887-40	24-5891-40	
	33	13	24-5888-33	24-5892-33	
	40	16	24-5888-40	24-5892-40	
	33	13	24-5889-33	24-5893-33	
	40	16	24-5889-40	24-5893-40	

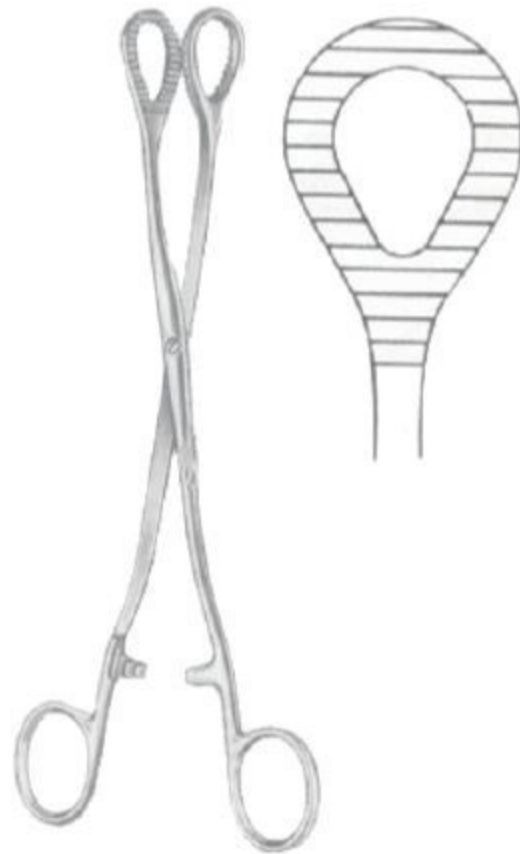

Heywood-Smith
 24-5895-21
 21 cm/8¼"



Heywood-Smith
 24-5896-21
 21 cm/8¼"

Rectal Snare

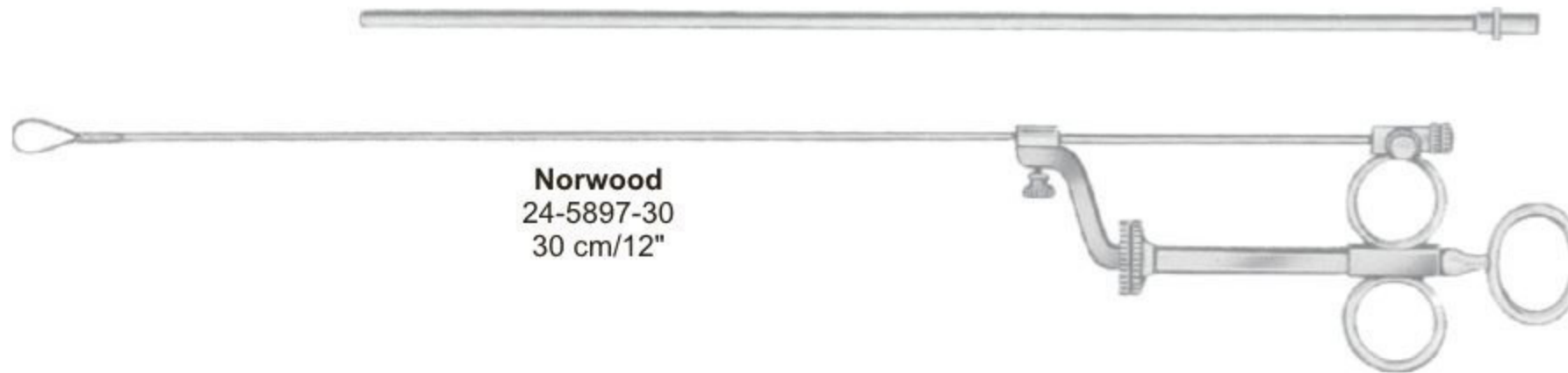

Norwood
 24-5897-30
 30 cm/12"

Rectal Aspiration Cannula



Buie
 24-5898-40
 Charr. 10. 40 cm/15¾"

Rectal Coolers



24-5899-01



24-5900-02

Aspiration Tip

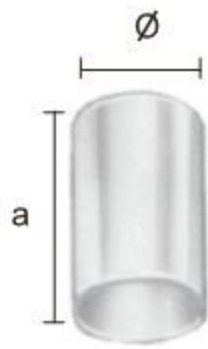

	a	∅
24-5901-11	11 mm	10 mm
24-5901-16	16 mm	10 mm

Charging Cone



10 mm ∅

24-5902-10

Charging Cone



12 mm ∅

24-5903-12

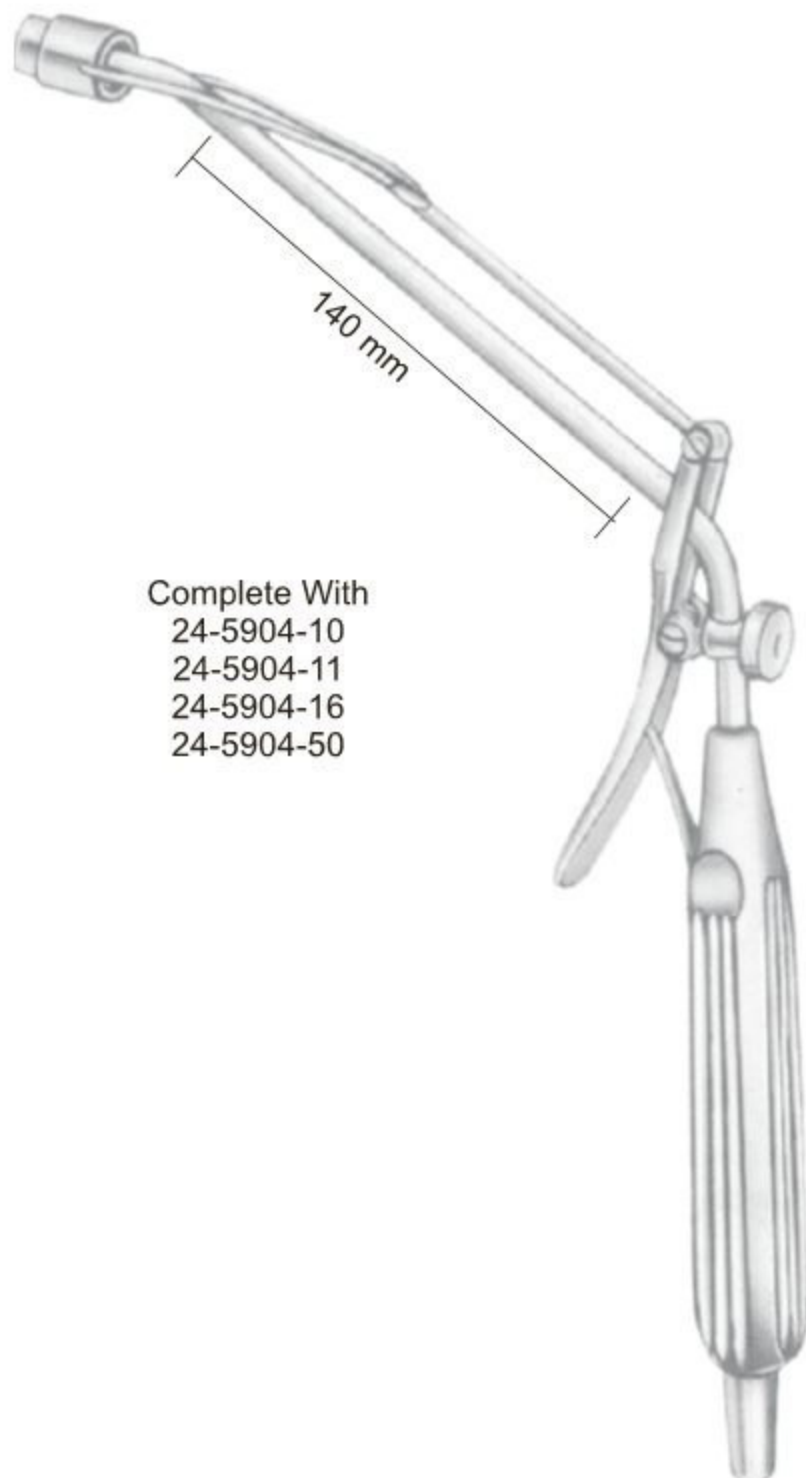

Complete With
 24-5904-10
 24-5904-11
 24-5904-16
 24-5904-50



Complete With
 24-5905-00
 24-5906-12
 24-5907-50

Rudd
 31.5 cm/12½"

- Haemorrhoidal Ligators ●— EN
- Haemorrhoidal Ligators ●— DE
- Ligators Haemorrhoidal ●— ES

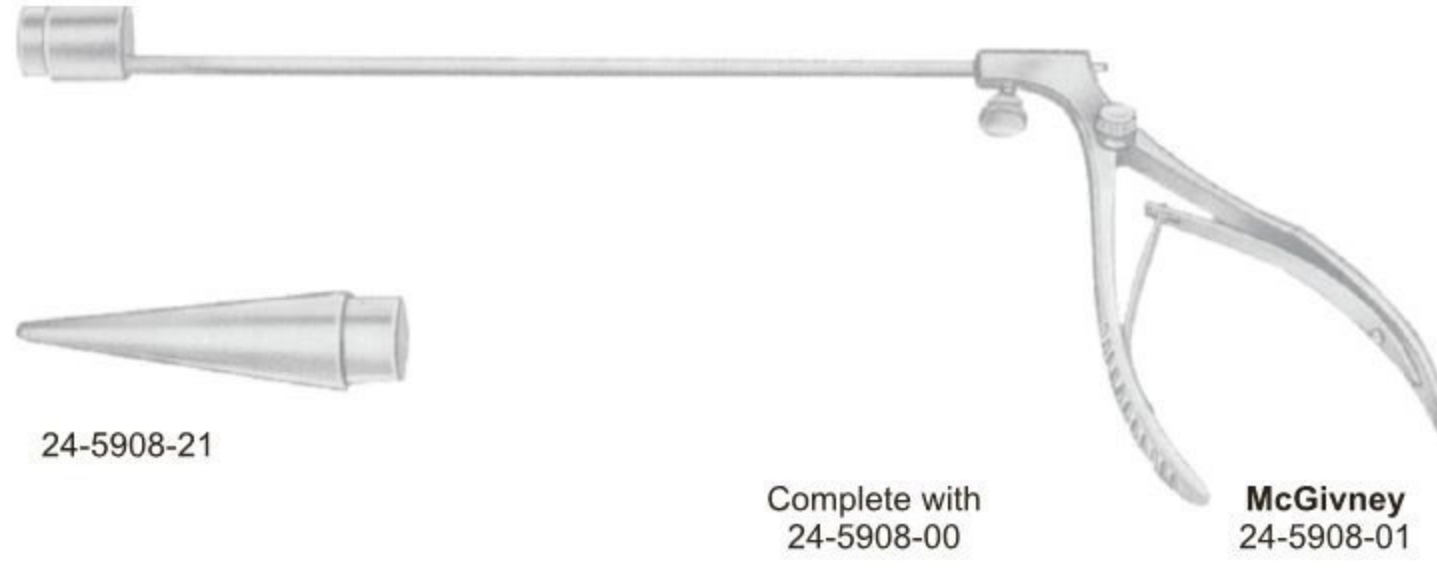

24-5908-21

Complete with
24-5908-00

McGivney
24-5908-01

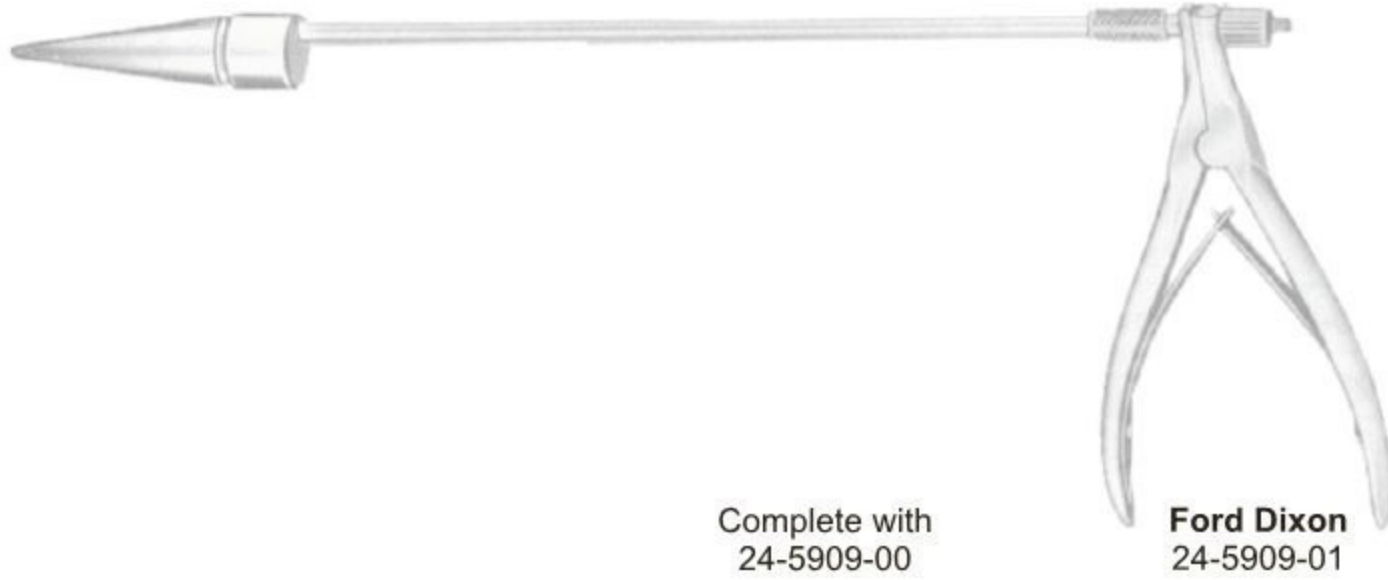

Complete with
24-5909-00

Ford Dixon
24-5909-01



Complete with
24-5911-00

24-5911-01



McGivney
24-5910-19
19 cm/7 1/2"



24-5912-00
Ligator rubber rings
in box of 100 pieces

- EN** Kidney, Liver, Gall Stone, Urology
- DE** Niere, Leber, Galle, Urologie
- ES** Riñón, Hígado, Bilis, Urología

Page 505 to 518





Guyon



25-6001-20
20 cm/8"



25-6001-22
22 cm/8¾"



25-6001-24
24 cm/9½"



25-6002-23
23 cm/9"



25-6002-24
24 cm/9½"

Atrauma



Guyon
25-6003-23
23 cm/9"

Kidney Pedicle Clamp Forceps ● EN
 Kidney Gestielte Klammerzange ● DE
 Pinzas de riñón Clamp pediculares ● ES



Herrick
 25-6004-23
 23 cm/9"



Mayo-Guyon
 25-6005-23
 23 cm/9"



Stille
 25-6006-23
 23 cm/9"

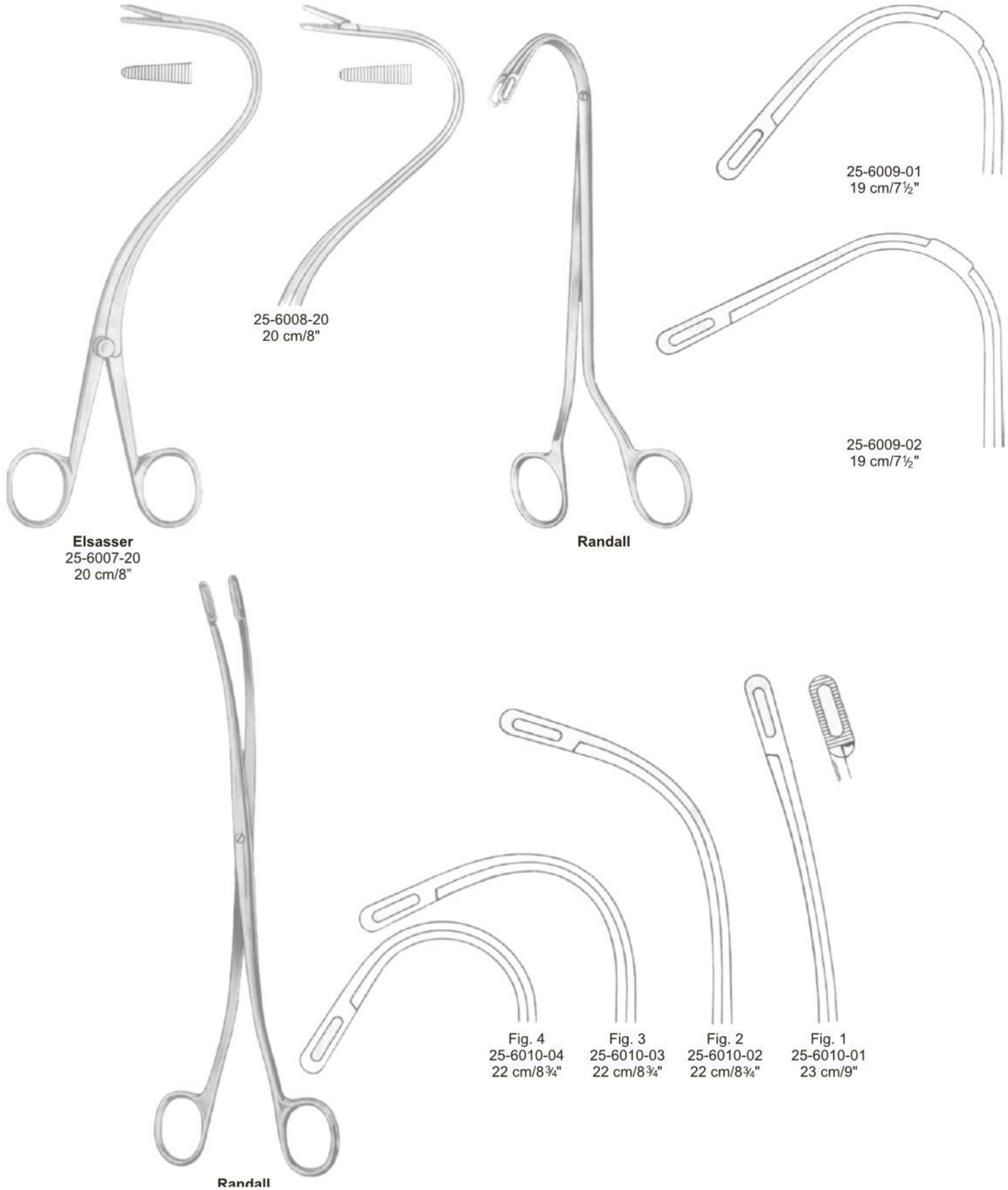

Gall Duct Forceps ●— EN
 Gall Duct Zange ●— DE
 Pinzas conducto biliar ●— ES



Gray
 25-6011-00

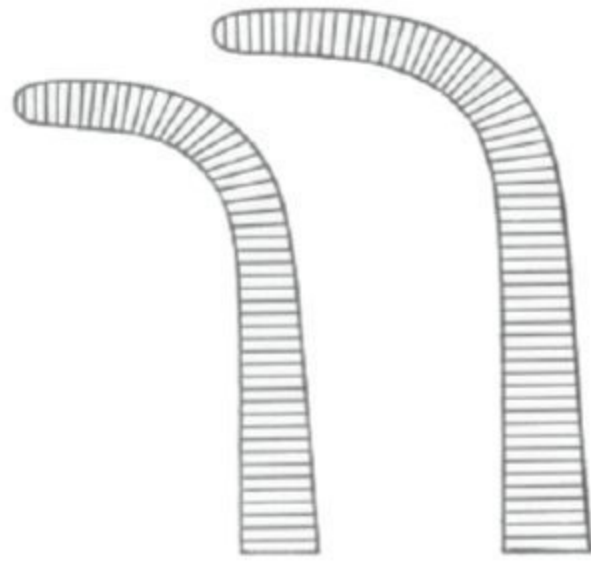

Fig. 1
 25-6011-01
 22 cm/8¾"

Fig. 2
 25-6011-02
 23 cm/9"

Set of 2 pieces



Gray
 25-6012-00

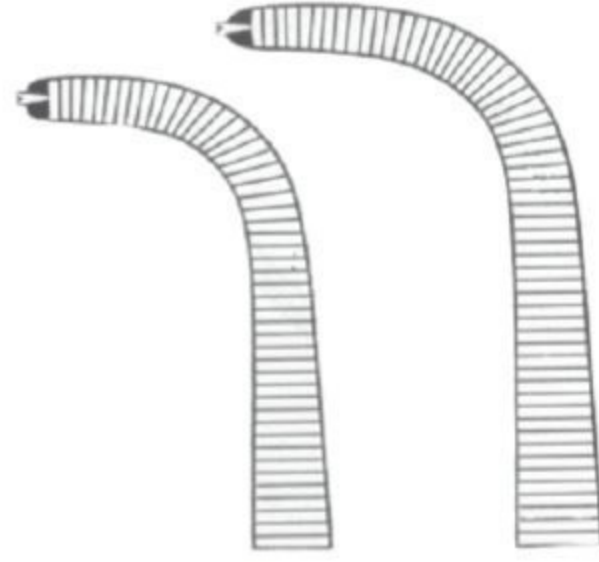

Fig. 1
 25-6012-01
 22 cm/8¾"

Fig. 2
 25-6012-02
 23 cm/9"

Set of 2 pieces



Gall duct and
 cystic forceps

Desjardins
 25-6013-21
 21 cm/8¼"



Nissen
 25-6014-21
 21.5 cm/8½"



Straight **Blake** Curved
 25-6015-20 20 cm/8" 25-6016-20



Straight **Mayo-Blake** Curved
 25-6017-20 20 cm/8" 25-6018-20



Czerny
 25-6019-24
 24.5 cm/9¾"



Desjardins
 23 cm/9"

Fig. 1
 25-6020-01

Fig. 2
 25-6021-02

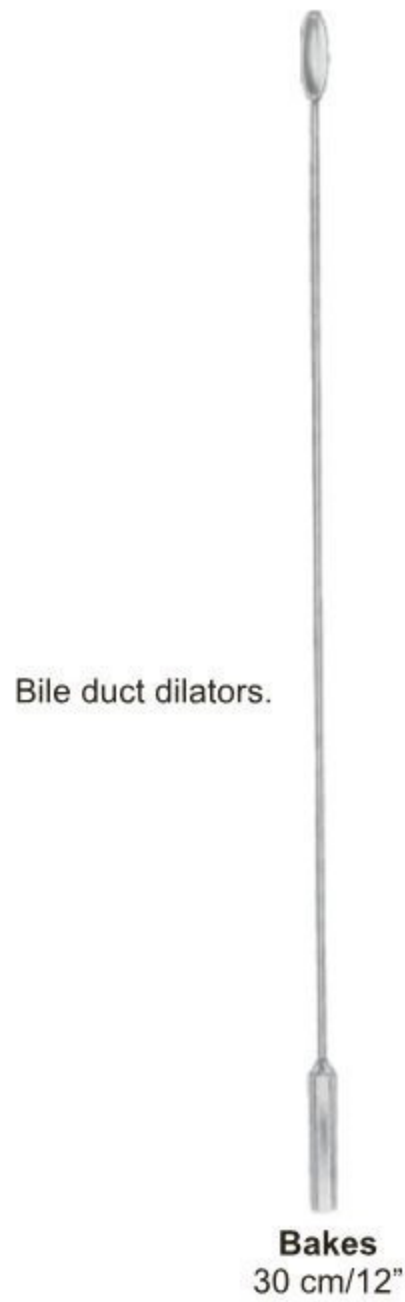

mm	
1	25-6025-01
2	25-6025-02
3	25-6025-03
4	25-6025-04
5	25-6025-05
6	25-6025-06
7	25-6025-07
8	25-6025-08
9	25-6025-09
10	25-6025-10
11	25-6025-11
12	25-6025-12
13	25-6025-13

25-6025-00
set of 9 pieces

25-6025-03 to 25-6025-11

25-6026-00
set of 9 pieces in canvas pocket

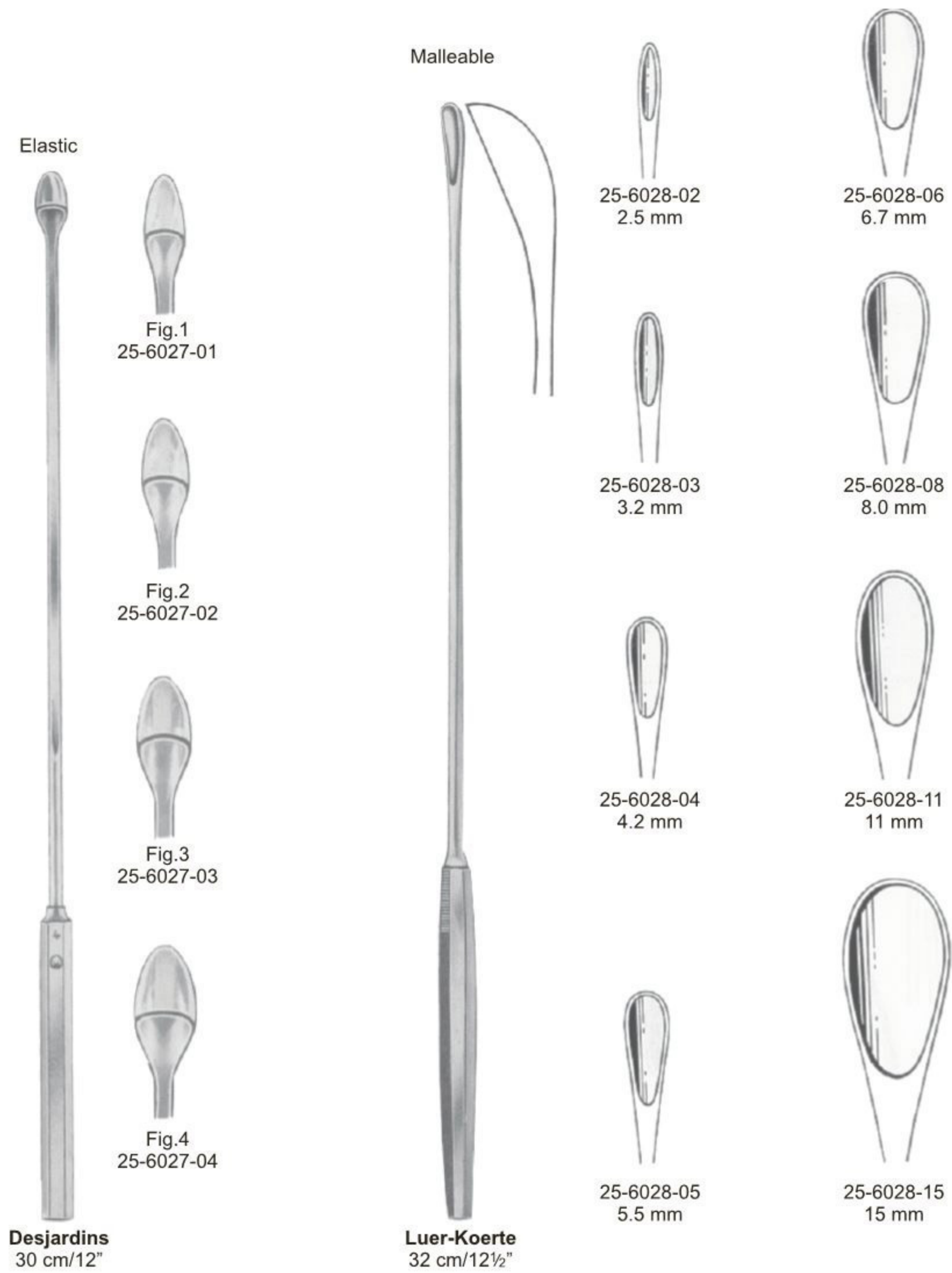

Gall Stone Scoops ● EN
 Gallensteinlöffel ● DE
 Cucharillas para coger cálculos biliares ● ES



Mayo
 25-6029-28
 28 cm/11"

Malleable



Mayo
 26.5 cm/10½"



Fig. 1
 25-6030-01



Fig. 2
 25-6030-02



Fig. 3
 25-6030-03



Moore
 26-08506-28
 28 cm/11"

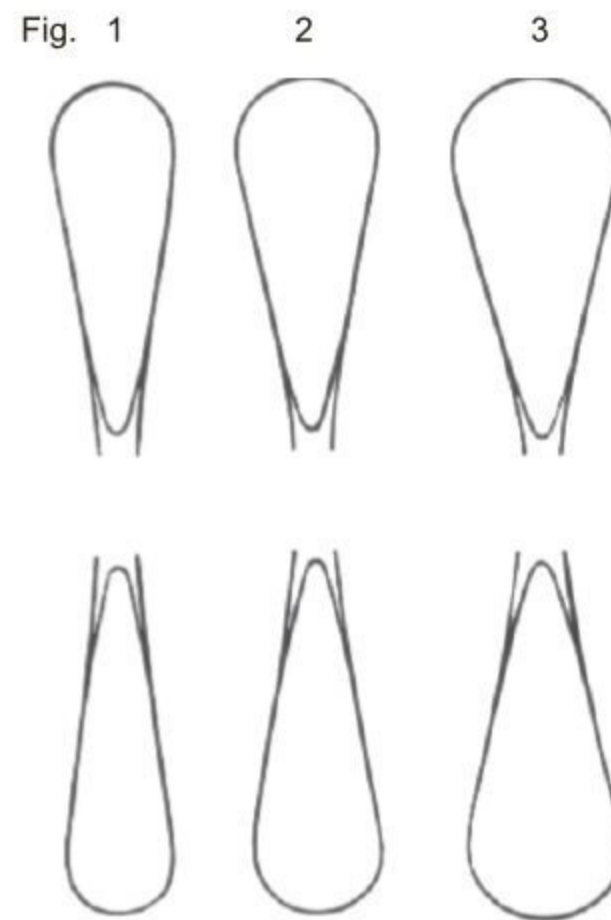
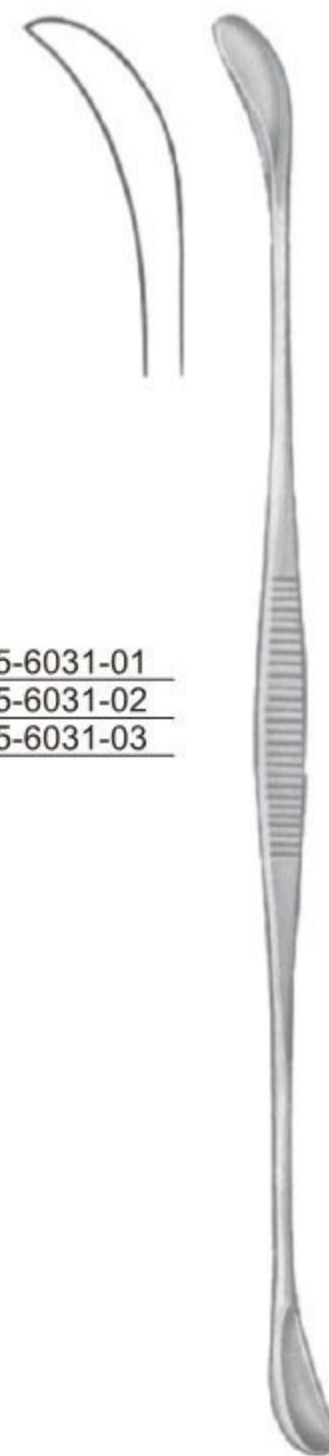

Fig.
 1 25-6031-01
 2 25-6031-02
 3 25-6031-03



Fergusson
 24 cm/9½"

- EN —● Prostatic Retractors, Prostatectomy instruments
- DE —● Postatachaken, Instrumente für prostata-operationen
- ES —● Separadores para la próstata, instrumentos para prostatectomía



Young
 25-6032-21
 21 cm/8 1/4"



Young
 25-6033-22
 22 cm/8 3/4"



Young
 25-6034-21
 21 cm/8 1/4"



Young
 25-6035-22
 22 cm/8 3/4"



Millin
 25-6036-23
 23 cm/9"



Millin
 25-6037-23
 23 cm/9"



Millin
 25-6038-23
 23 cm/9"

Bladder Retractors ● EN
 Blasen-Wudspreizer ● DE
 Separadores vesicales ● ES



Millin
 25-6039-24
 24 cm/9½"

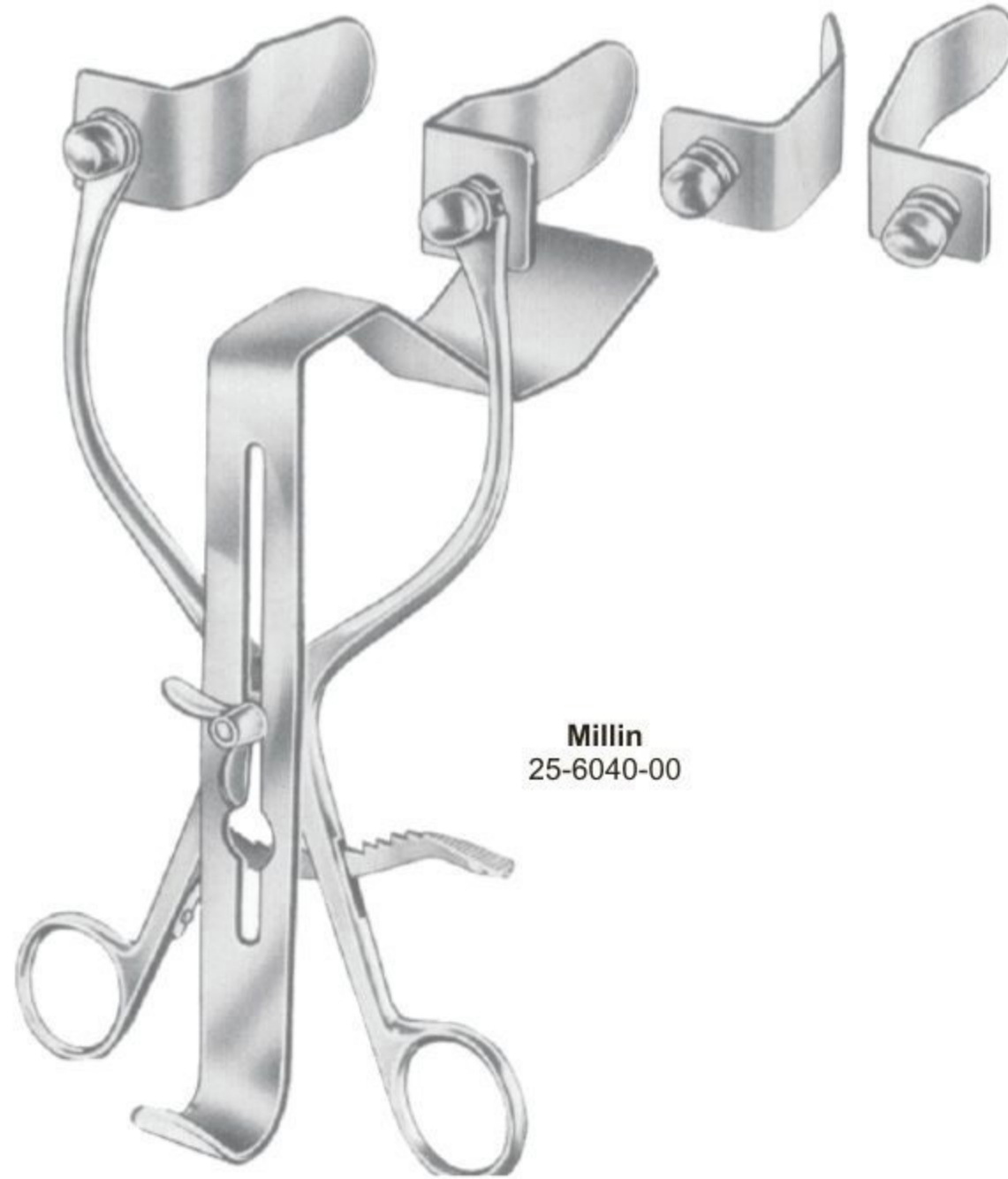

Millin
 25-6040-00



Legueu
 25-6041-00



Judd-Masson
 25-6042-00

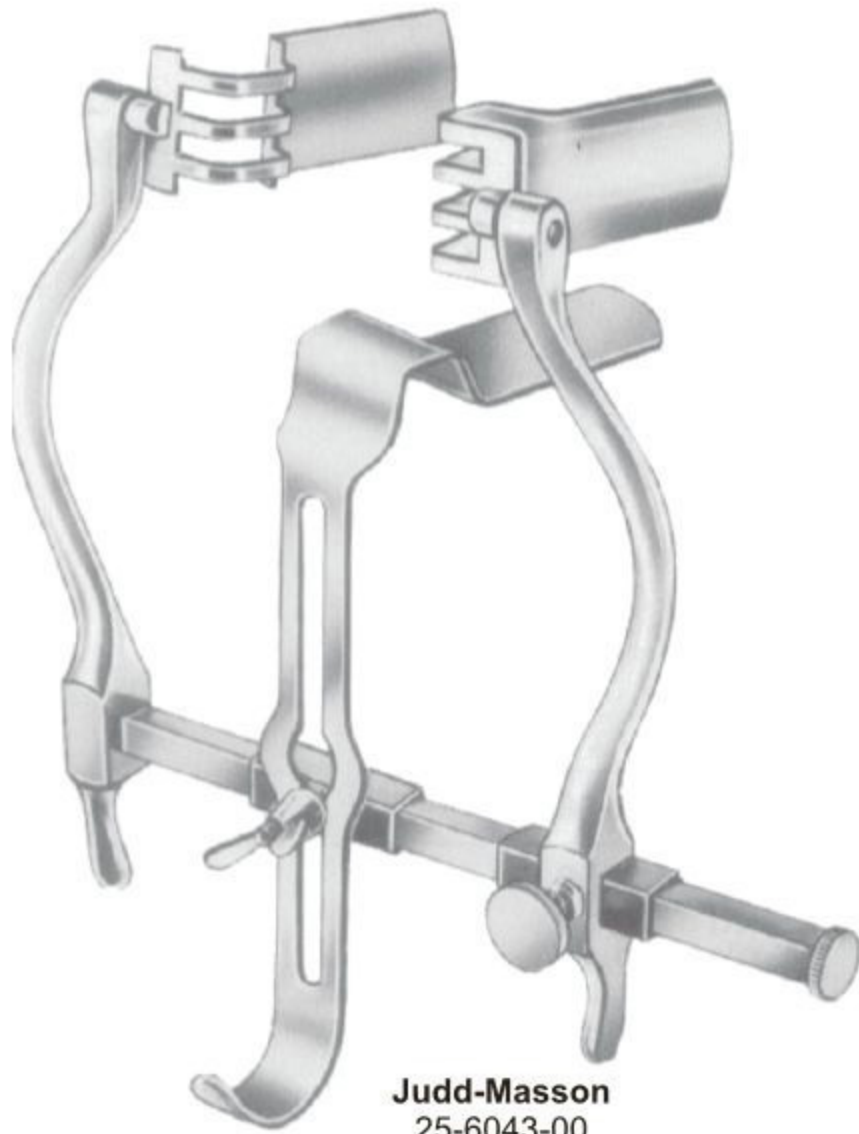

Judd-Masson
 25-6043-00



Thomson-Walker
 25-6044-00



Legueu
 25-6045-27
 27 cm/10½"
 35 mm



Kocher
 25-6046-26
 26 cm/10¼"
 67 mm

Dilating Bougies ●— EN
 Dilatationsbougies ●— DE
 Bujías dilatadoras ●— ES

mm Ø	Charriere (French)
2 2/3	8
3	9
3 1/3	10
3 2/3	11
4	12
4 1/3	13
4 2/3	14
5	15
5 1/3	16
5 2/3	17
6	18
6 1/3	19
6 2/3	20
7	21
7 1/3	22
7 2/3	23
8	24
8 1/3	25
8 2/3	26
9	27
9 1/3	28
9 2/3	29
10	30
10 1/3	32
11 2/3	34
12	36



Van Buren
 Charrier (French)
 No. 8-36
 25-6047-08
 25-6047-36
 28 cm/11"
 In Canvas Pouch
 25-6047-50
 Set of 6
 6 Pcs. 25-6047-14/24
 25-6047-24
 25-6047-60
 Set of 12
 12 Pcs 25-6047-08/36
 25-6047-36

- 25-6047-08
- 25-6047-10
- 25-6047-12
- 25-6047-14
- 25-6047-16
- 25-6047-18
- 25-6047-20
- 25-6047-22
- 25-6047-24
- 25-6047-26
- 25-6047-28
- 25-6047-30
- 25-6047-32
- 25-6047-34
- 25-6047-36



Dittel
 Charriere (French)
 No. 8-30
 25-6048-08
 25-6048-30
 19.5 cm/7 1/2"

- Straight
- 25-6048-08
 - 25-6048-09
 - 25-6048-10
 - 25-6048-11
 - 25-6048-12
 - 25-6048-13
 - 25-6048-14
 - 25-6048-15
 - 25-6048-16
 - 25-6048-17
 - 25-6048-18
 - 25-6048-19
 - 25-6048-20
 - 25-6048-21
 - 25-6048-22
 - 25-6048-23
 - 25-6048-24
 - 25-6048-25
 - 25-6048-26
 - 25-6048-27
 - 25-6048-28
 - 25-6048-26
 - 25-6048-30



Dittel
 Charriere (French)
 No. 8-30
 25-6049-08
 25-6049-30
 34.5 cm/13 1/2"

- Curved
- 25-6049-08
 - 25-6049-09
 - 25-6049-10
 - 25-6049-11
 - 25-6049-12
 - 25-6049-13
 - 25-6049-14
 - 25-6049-15
 - 25-6049-16
 - 25-6049-17
 - 25-6049-18
 - 25-6049-19
 - 25-6049-20
 - 25-6049-21
 - 25-6049-22
 - 25-6049-23
 - 25-6049-24
 - 25-6049-25
 - 25-6049-26
 - 25-6049-27
 - 25-6049-28
 - 25-6049-26
 - 25-6049-30

For men



25-6050-06
 25-6050-24

For Women



	mm Ø	Charriere (French)	
25-6050-06	2	6	25-6051-06
25-6050-07	2 ¹ / ₃	7	25-6051-07
25-6050-08	2 ² / ₃	8	25-6051-08
25-6050-09	3	9	25-6051-09
25-6050-10	3 ¹ / ₃	10	25-6051-10
25-6050-11	3 ² / ₃	11	25-6051-11
25-6050-12	4	12	25-6051-12
25-6050-13	4 ¹ / ₃	13	25-6051-13
25-6050-14	4 ² / ₃	14	25-6051-14
25-6050-15	5	15	25-6051-15
25-6050-16	5 ¹ / ₃	16	25-6051-16
25-6050-17	5 ² / ₃	17	25-6051-17
25-6050-18	6	18	25-6051-18
25-6050-19	6 ¹ / ₃	19	25-6051-19
25-6050-20	6 ² / ₃	20	25-6051-20
25-6050-21	7	21	25-6051-21
25-6050-22	7 ¹ / ₃	22	25-6051-22
25-6050-23	7 ² / ₃	23	25-6051-23
25-6050-24	8	24	25-6051-24

Catheter Introducing Instruments



Guyon
 25-6052-39
 39 cm/15¹/₂"



Guyon
 25-6053-35
 35 cm/13³/₄"

Urology Instruments ● EN
 Urologie Instruments ● DE
 Instrumentos Urología ● ES

Circumcision Instruments

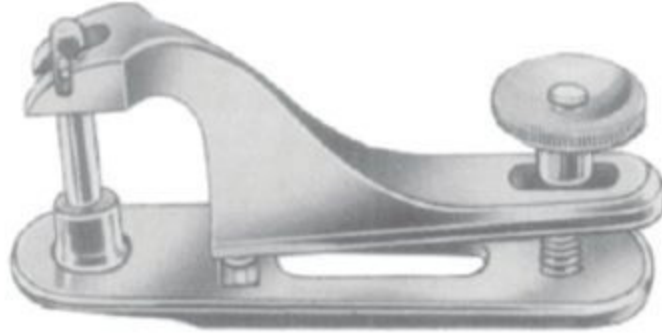

25-6054-08	08 mm
25-6054-11	11 mm
25-6054-13	13 mm
25-6054-16	16 mm
25-6054-21	21 mm
25-6054-26	26 mm
25-6054-32	32 mm

Foreign Body Forceps



Mathieu
 25-6055-20

Penis Clamps

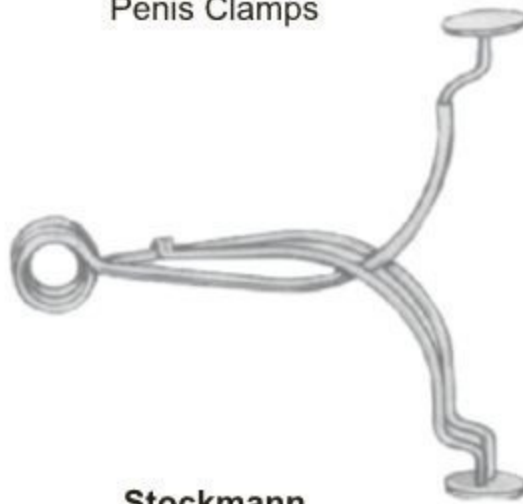

Stockmann
 25-6056-00



Strauss
 25-6057-00

Secretion Scoop



Guttman
 25-6058-26
 26.5 cm/10½"

- EN** Gynecology
- DE** Gynäkologie
- ES** Ginecología

Page 519 to 558



Scheme of Dimensions for Specula

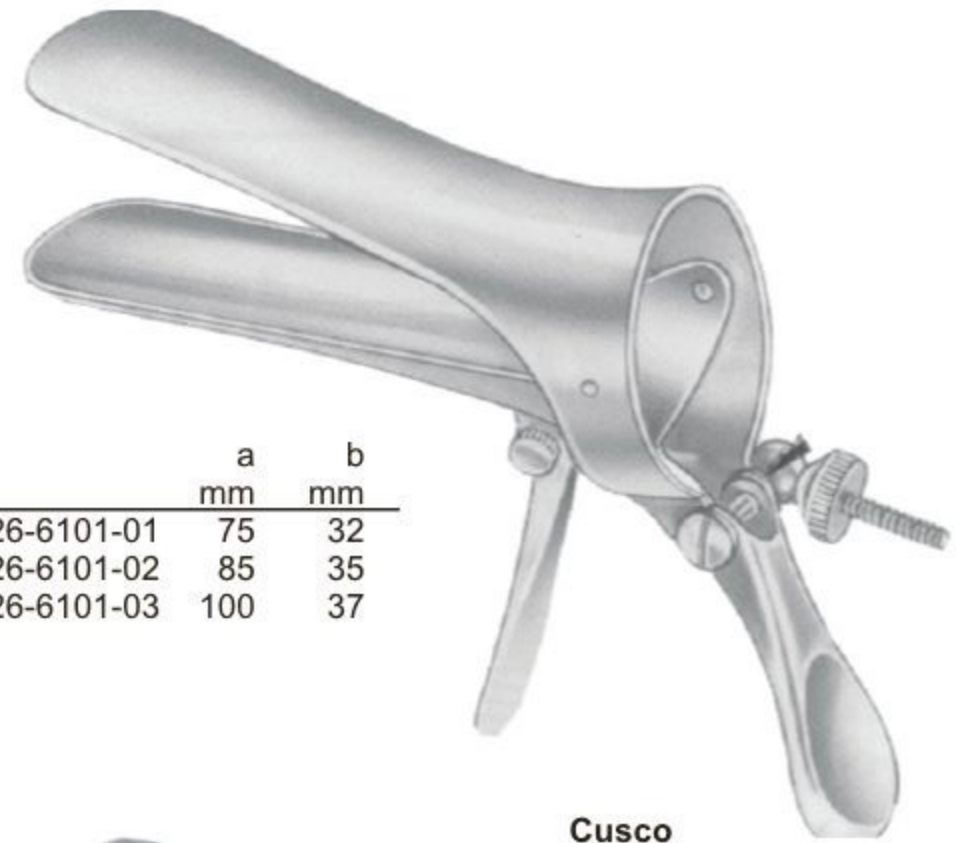
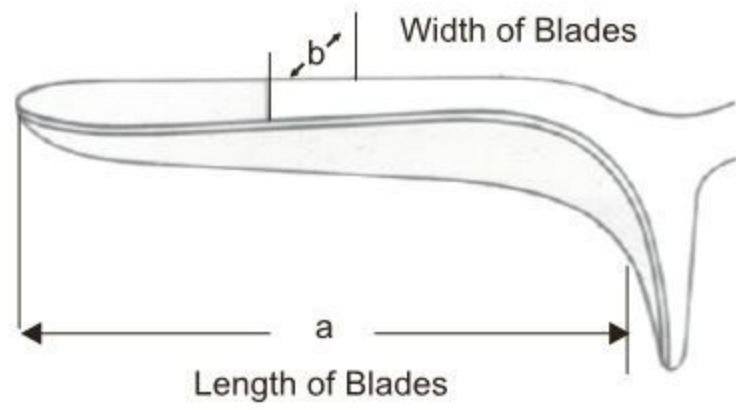

	a mm	b mm
26-6101-01	75	32
26-6101-02	85	35
26-6101-03	100	37

Cusco

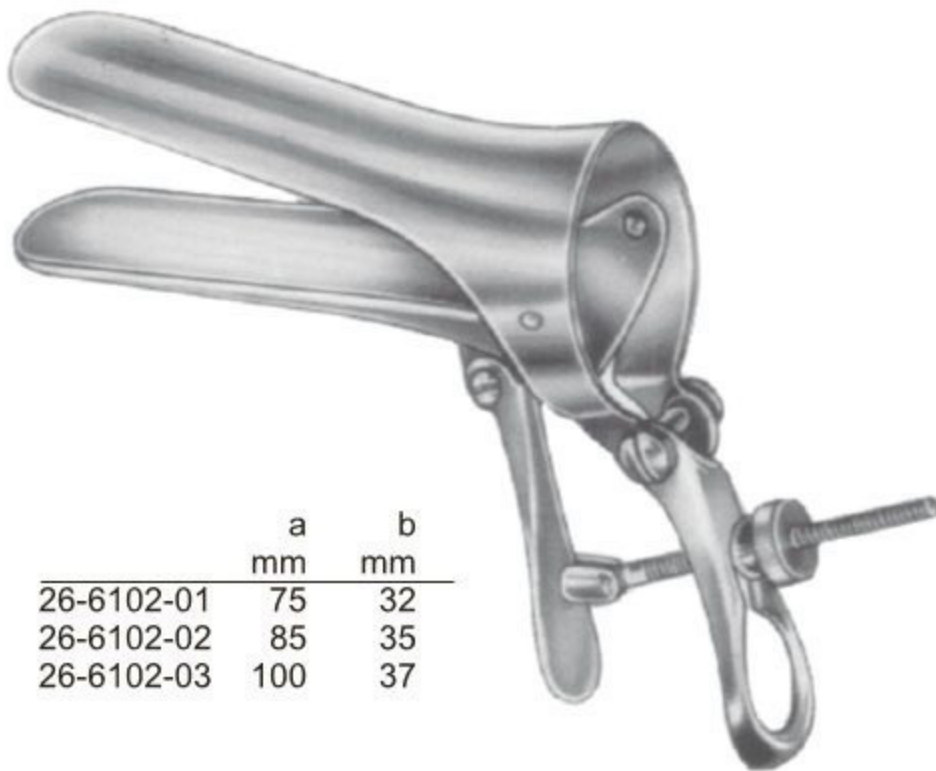

	a mm	b mm
26-6102-01	75	32
26-6102-02	85	35
26-6102-03	100	37

Cusco



For Virgins	a mm	b mm
26-6103-00	75	17

Cusco

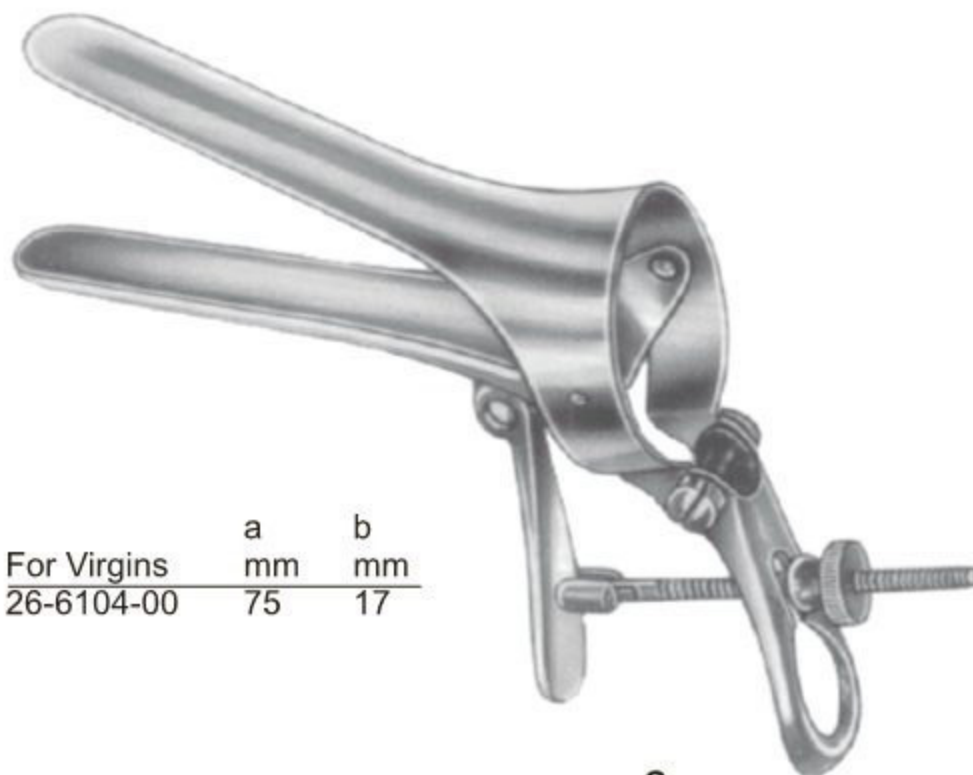

For Virgins	a mm	b mm
26-6104-00	75	17

Cusco



	a mm	b mm
26-6105-01	90	23-25
26-6105-02	100	25-27
26-6105-03	110	27-30

Cusco
 Swiss Pattern

Vaginal Speculas ● EN
 Scheidenspekula ● DE
 Espéculos vaginales ● ES

**Collin-Landau**

Small	26-6106-01	30 x 85 mm
Medium	26-6106-02	35 x 100 mm
Large	26-6106-03	40 x 110 mm

**Collin**

Small	26-6107-01	30 x 85 mm
Medium	26-6107-02	35 x 100 mm
Large	26-6107-03	40 x 110 mm

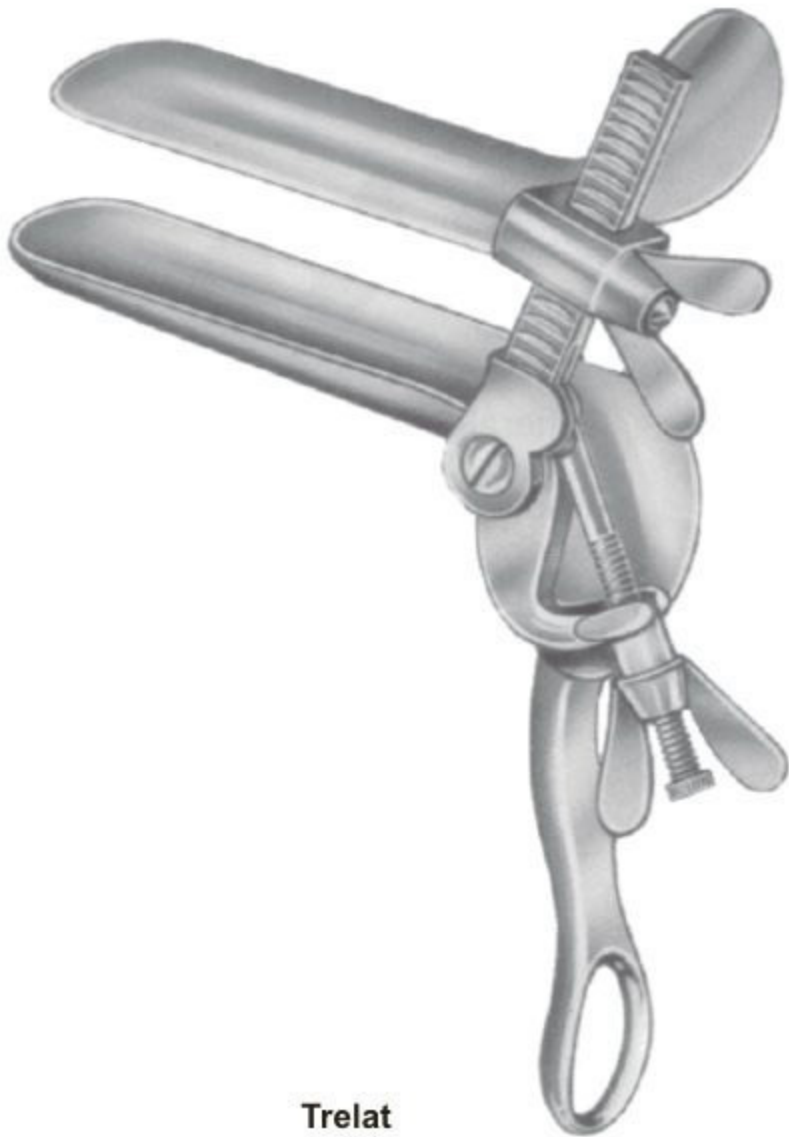
**Trelat**

	a	b
	mm	mm
26-6108-01	85	33
26-6108-02	95	35
26-6108-03	115	43

**Grave (Standard)**

	a	b
	mm	mm
26-6109-01	75	20
26-6109-02	95	30
26-6109-03	115	35
26-6109-04	125	35

Black



Grave	a mm	b mm
26-6110-01	75	20
26-6110-02	95	35
26-6110-03	115	35



Grave	a mm	b mm
Angled 135° 26-6111-00	101	35

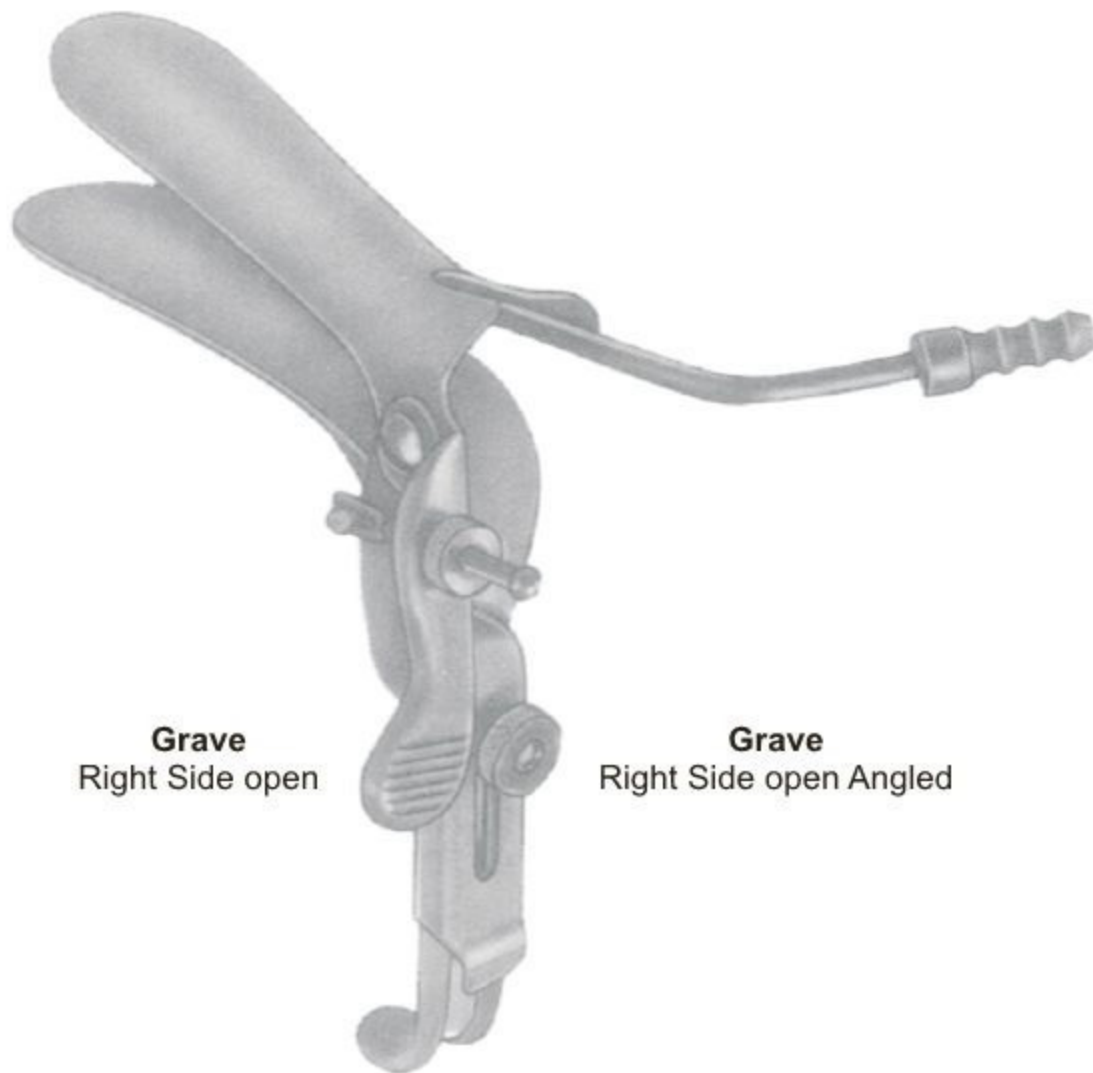

Grave
Right Side open

Grave
Right Side open Angled

	a mm	b mm
26-6112-01	101	35
26-6112-02	101	35

Lateral Specula



26-6113-00



Pederson

	a mm	b mm
26-6114-01	75	13
26-6114-02	100	22
26-6114-03	120	25

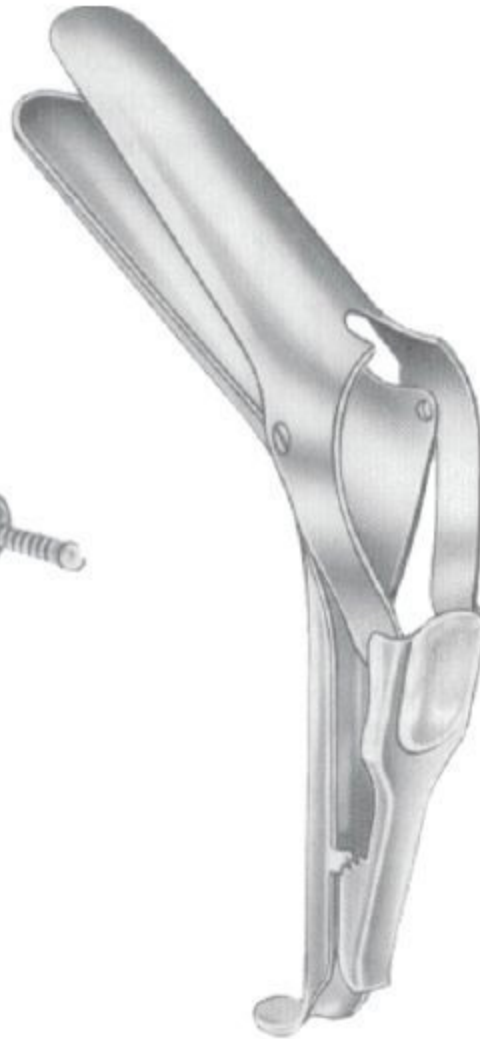

Semm

	a mm	b mm
26-6115-01	90	14/18
26-6115-02	100	17/20
26-6115-03	100	25/30



Nott

	a mm	b mm
26-6116-01	90	30
26-6116-02	110	30

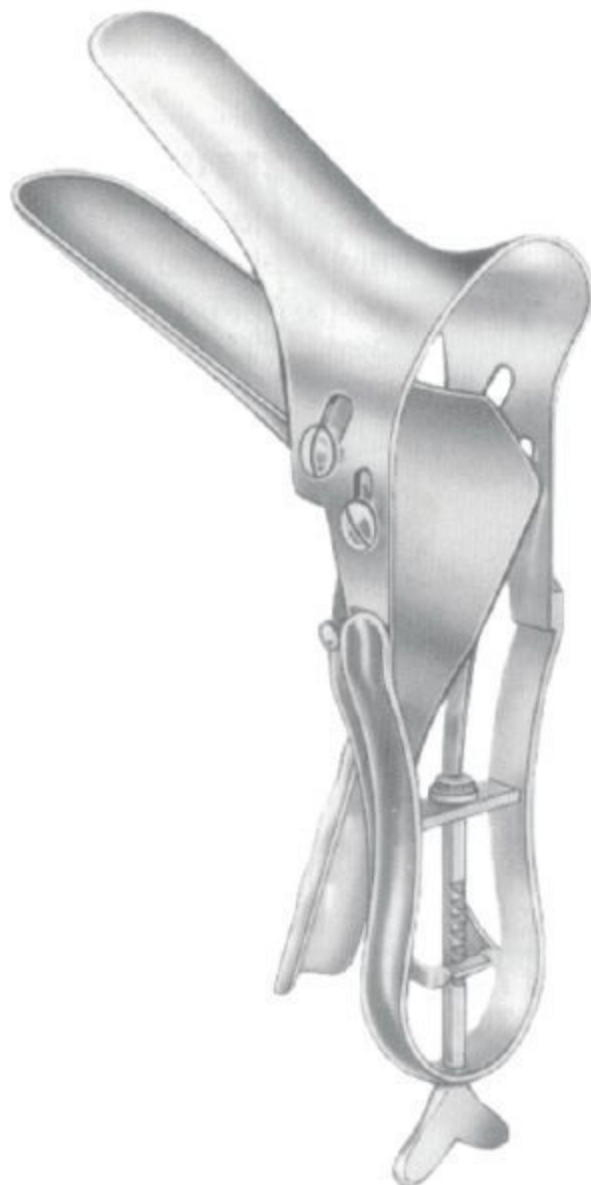

Seyffert

	a mm	b mm
26-6117-01	100	17
26-6117-02	110	33



One Side open

Seyffert

	a mm	b mm
26-6118-02	110	33

Scheme of Dimensions for Specula

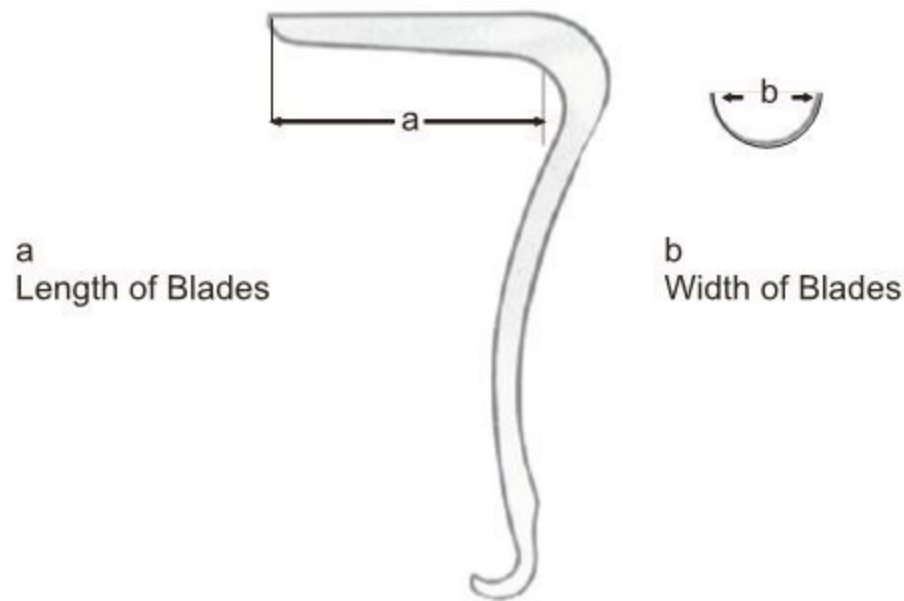

Sims (single ended)

26-6119-01	63 x 32 mm
26-6119-02	76 x 32 mm
26-6119-03	89 x 38 mm



Sims (double ended)

26-6120-01	26 x 70 mm (30 x 75 mm)
26-6120-02	30 x 75 mm (35 x 80 mm)
26-6120-03	36 x 80 mm (40 x 90 mm)



Jackson

	Fig.	a mm	b mm
26-6121-01	1	75 X 40	
26-6121-02	2	90 X 40	
26-6121-03	3	100 X 40	



Eastman

	Fig.	a mm	b mm
26-6122-01	1	76	38
26-6122-02	2	89	38
26-6122-03	3	101	38

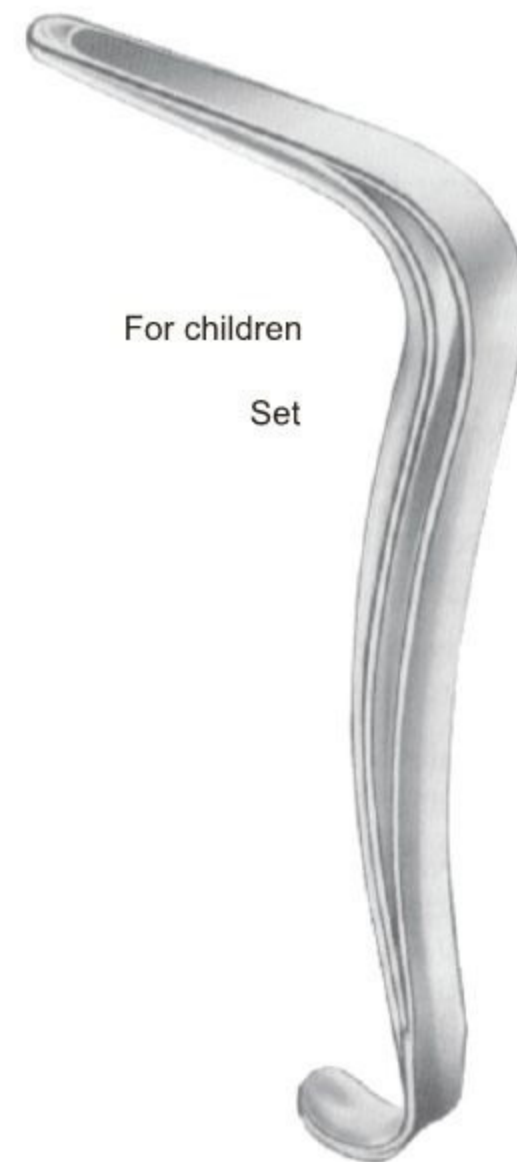

For children

Set

Kristeller

26-6123-00
 70x15 mm

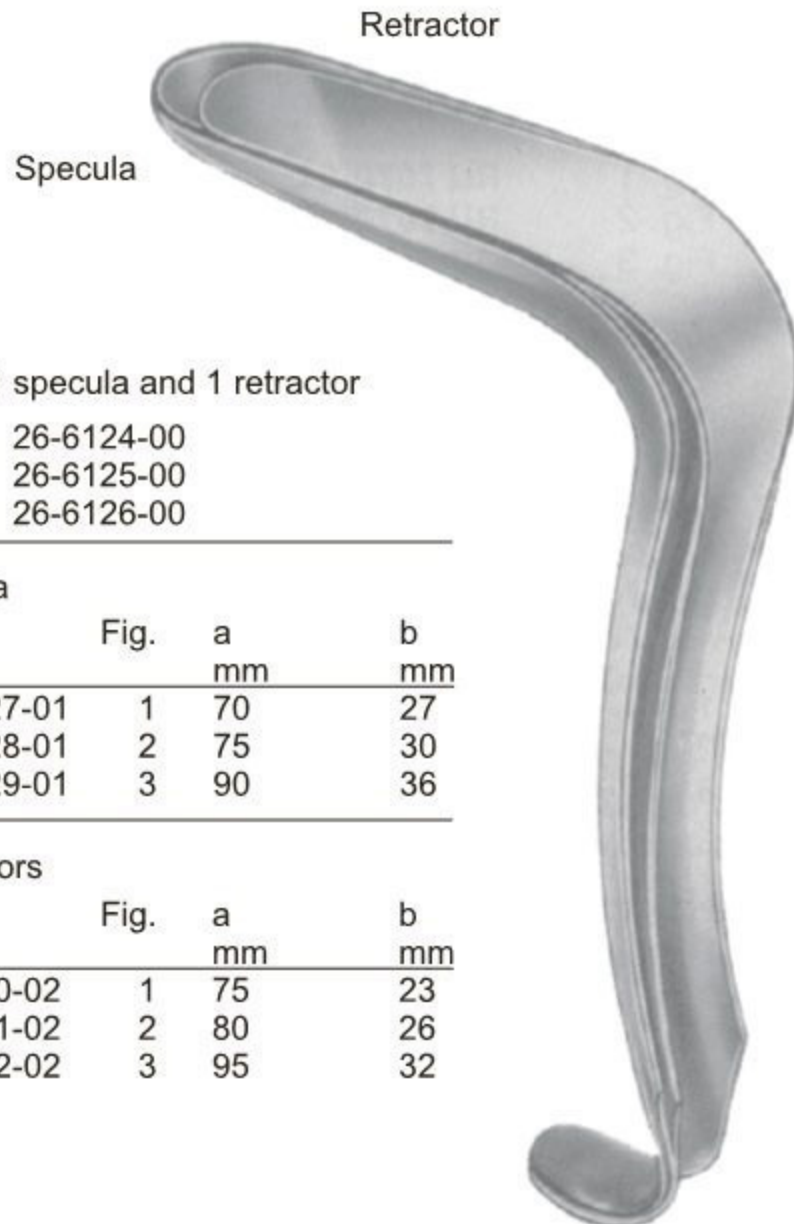

Set of 1 specula and 1 retractor

- Fig. 1 26-6124-00
- Fig. 2 26-6125-00
- Fig. 3 26-6126-00

Specula

	Fig.	a	b
		mm	mm
26-6127-01	1	70	27
26-6128-01	2	75	30
26-6129-01	3	90	36

Retractors

	Fig.	a	b
		mm	mm
26-6130-02	1	75	23
26-6131-02	2	80	26
26-6132-02	3	95	32

Kristeller
(Standard)

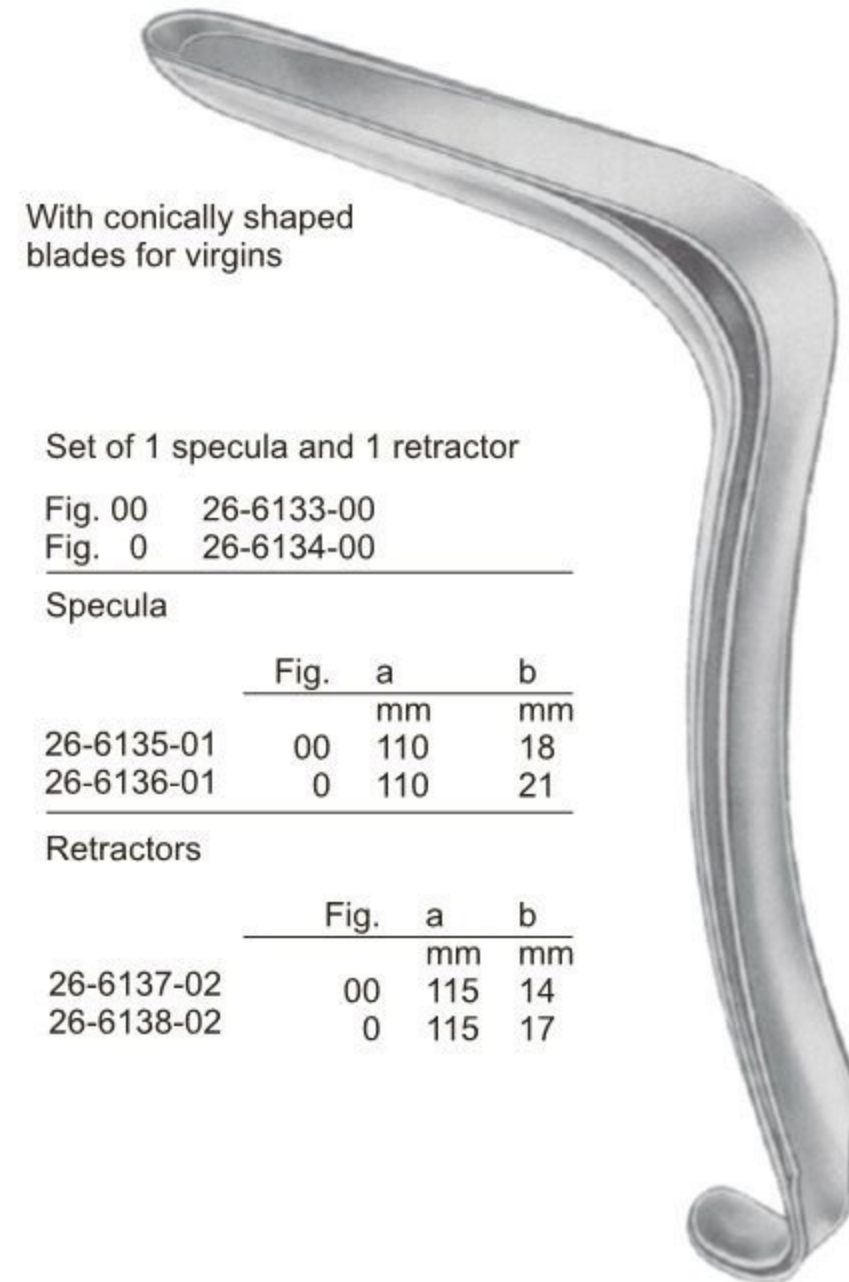

With conically shaped blades for virgins

Set of 1 specula and 1 retractor

- Fig. 00 26-6133-00
- Fig. 0 26-6134-00

Specula

	Fig.	a	b
		mm	mm
26-6135-01	00	110	18
26-6136-01	0	110	21

Retractors

	Fig.	a	b
		mm	mm
26-6137-02	00	115	14
26-6138-02	0	115	17

Kristeller

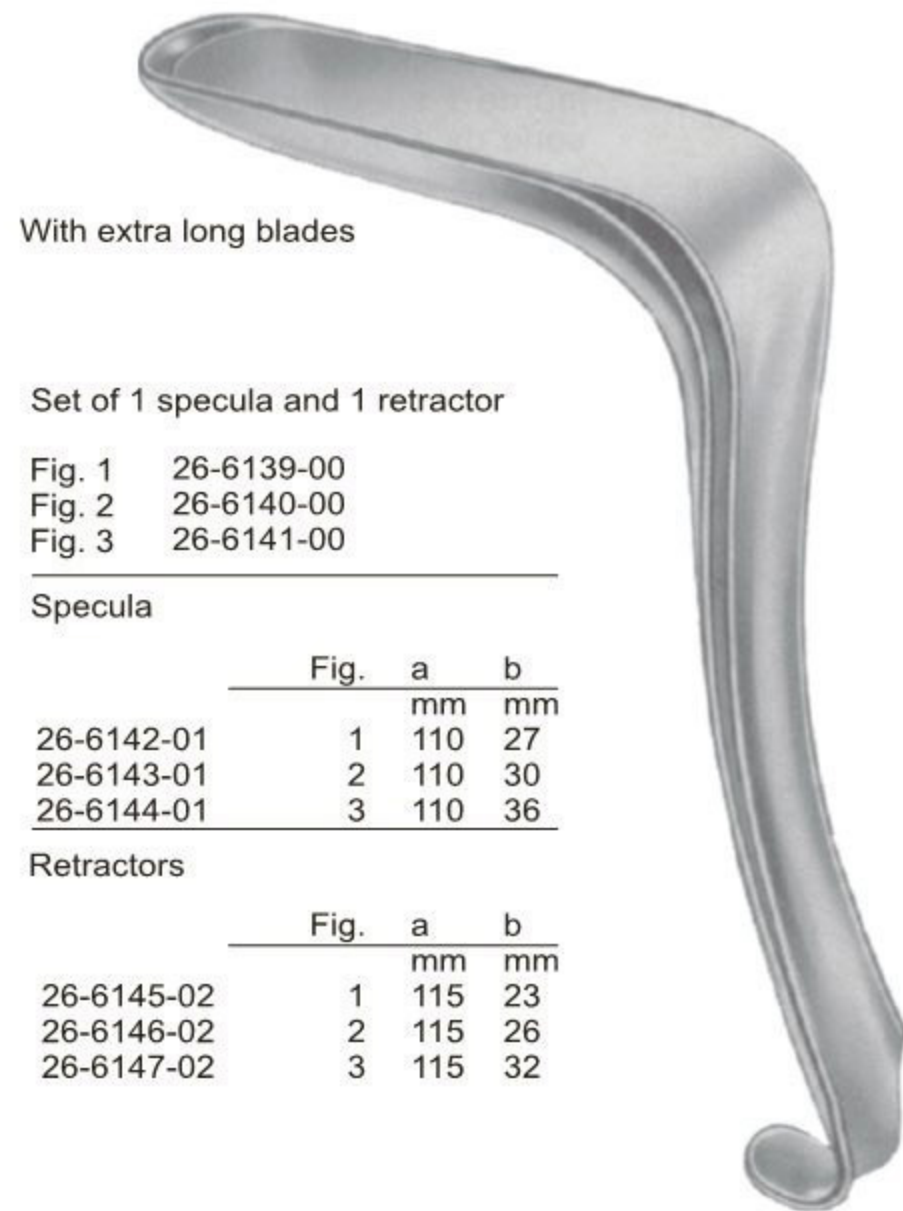

With extra long blades

Set of 1 specula and 1 retractor

- Fig. 1 26-6139-00
- Fig. 2 26-6140-00
- Fig. 3 26-6141-00

Specula

	Fig.	a	b
		mm	mm
26-6142-01	1	110	27
26-6143-01	2	110	30
26-6144-01	3	110	36

Retractors

	Fig.	a	b
		mm	mm
26-6145-02	1	115	23
26-6146-02	2	115	26
26-6147-02	3	115	32

Kristeller
(Standard)

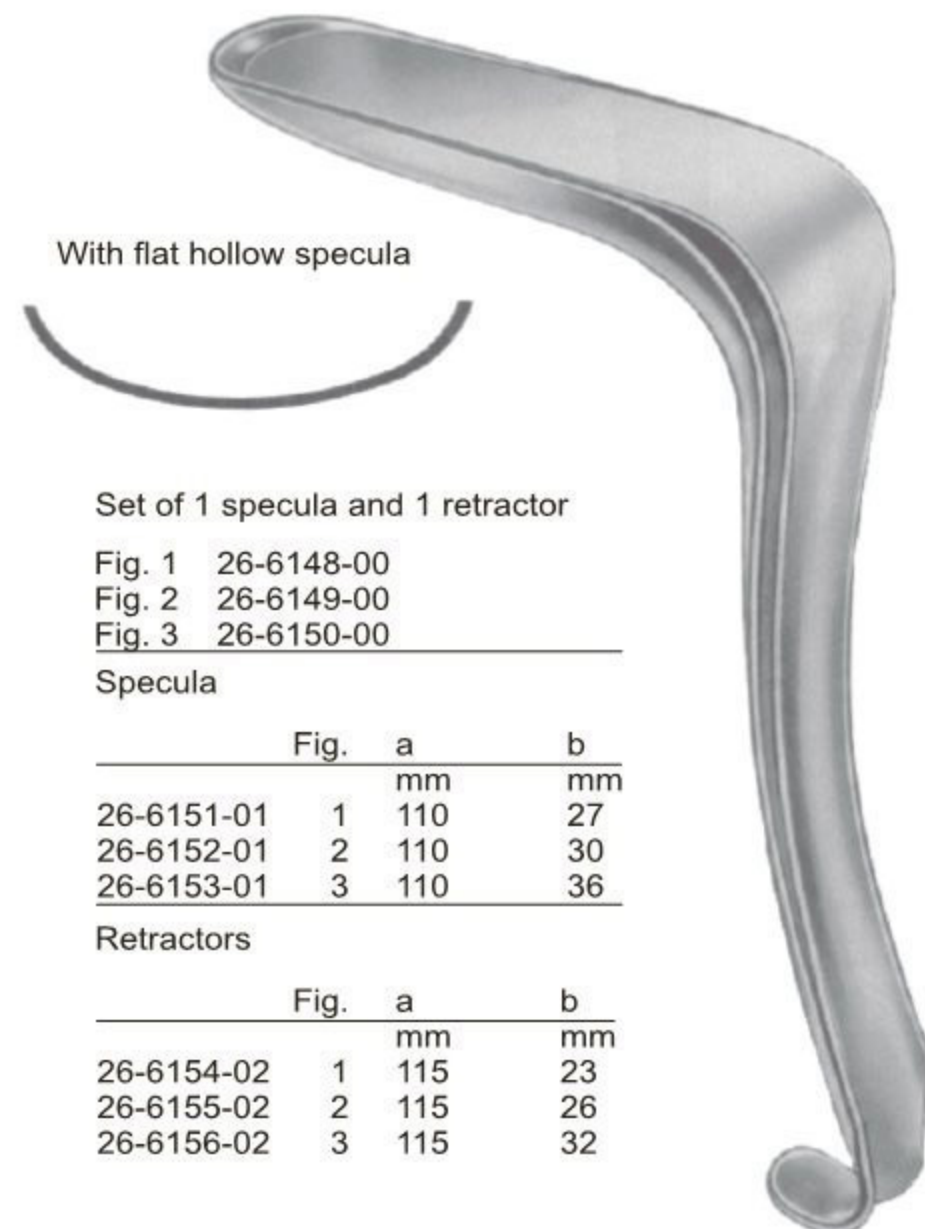

With flat hollow specula

Set of 1 specula and 1 retractor

- Fig. 1 26-6148-00
- Fig. 2 26-6149-00
- Fig. 3 26-6150-00

Specula

	Fig.	a	b
		mm	mm
26-6151-01	1	110	27
26-6152-01	2	110	30
26-6153-01	3	110	36

Retractors

	Fig.	a	b
		mm	mm
26-6154-02	1	115	23
26-6155-02	2	115	26
26-6156-02	3	115	32

Kristeller

	a mm	b mm
26-6157-20	100	20
26-6157-25	100	25
26-6157-30	100	30
26-6157-35	100	35
26-6157-40	100	40
26-6158-20	130	20
26-6158-25	130	25
26-6158-30	130	30
26-6158-35	130	35
26-6158-40	130	40

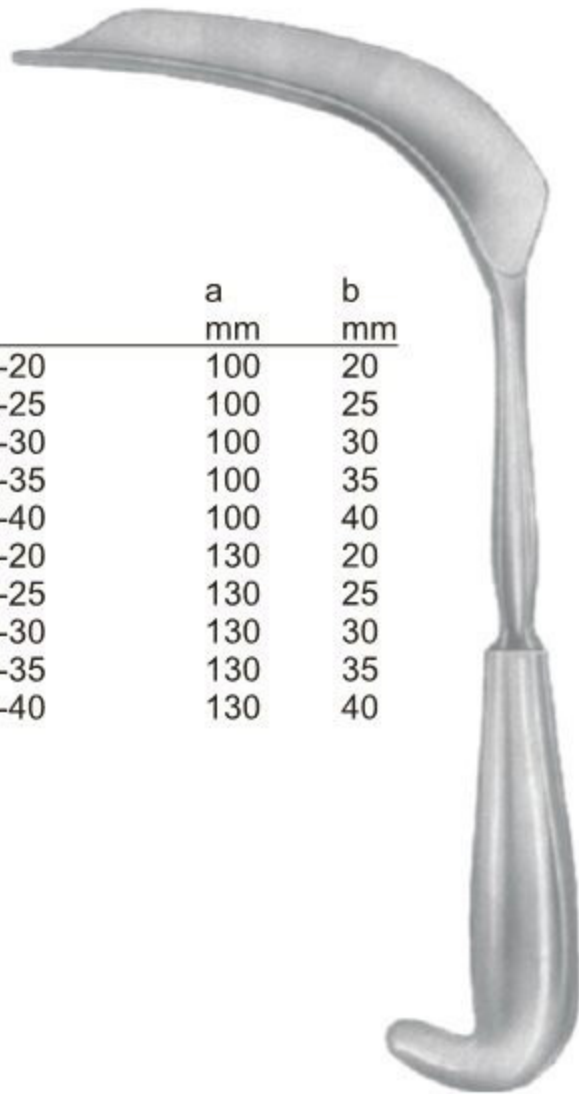

Matzenauer



Braun
 26-6159-18
 18 cm/7"
 56x13 mm



Braun
 26-6160-18
 18 cm/7"
 60x10 mm



Ulrich
 26-6161-19
 19.5 cm/7½"
 80x20 mm



26-6162-19
 19 cm/7½"
 85x17 mm

Set

26-6163-00	Fig. 1
26-6164-00	Fig. 2

Specula

	Fig.	a mm	b mm
26-6165-01	1	70	40
26-6166-01	2	90	40

Retractors

	Fig.	a mm	b mm
26-6167-02	1	70	33
26-6168-02	2	90	33

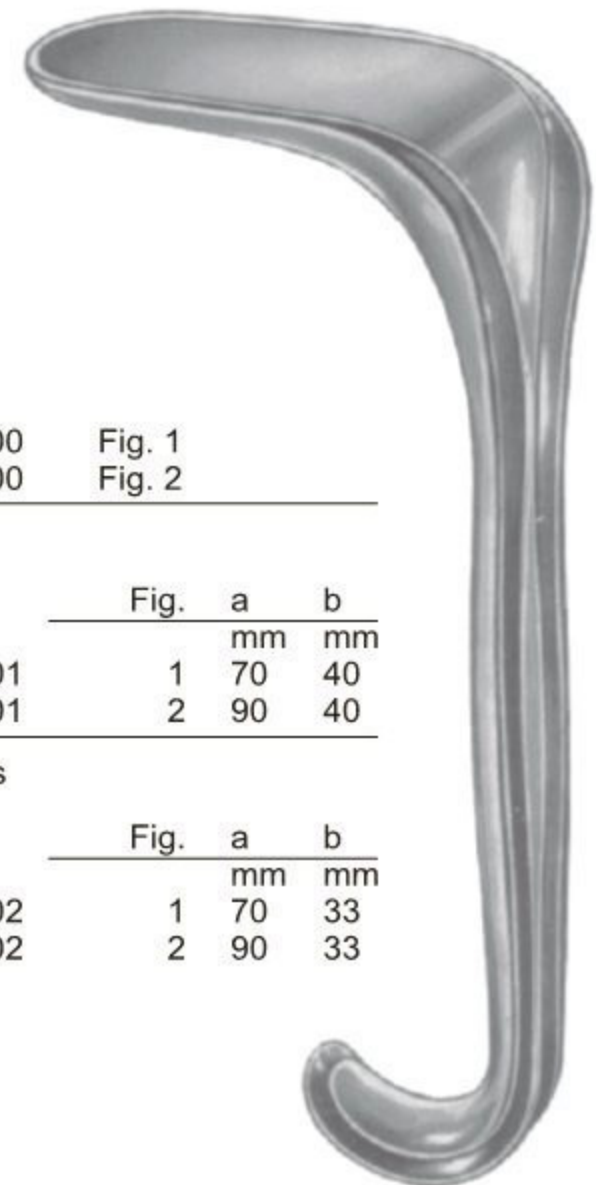

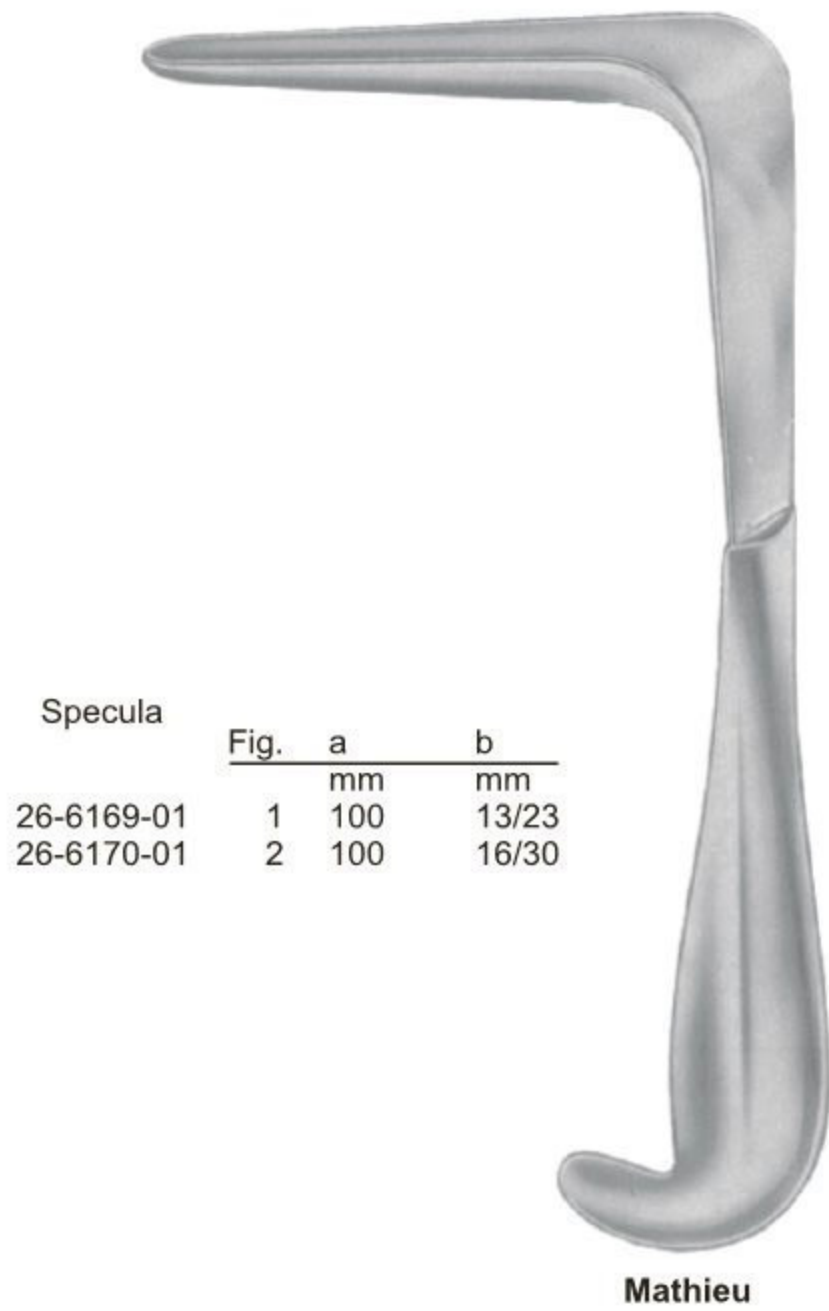

Specula			
	Fig.	a	b
		mm	mm
26-6169-01	1	100	13/23
26-6170-01	2	100	16/30

Mathieu

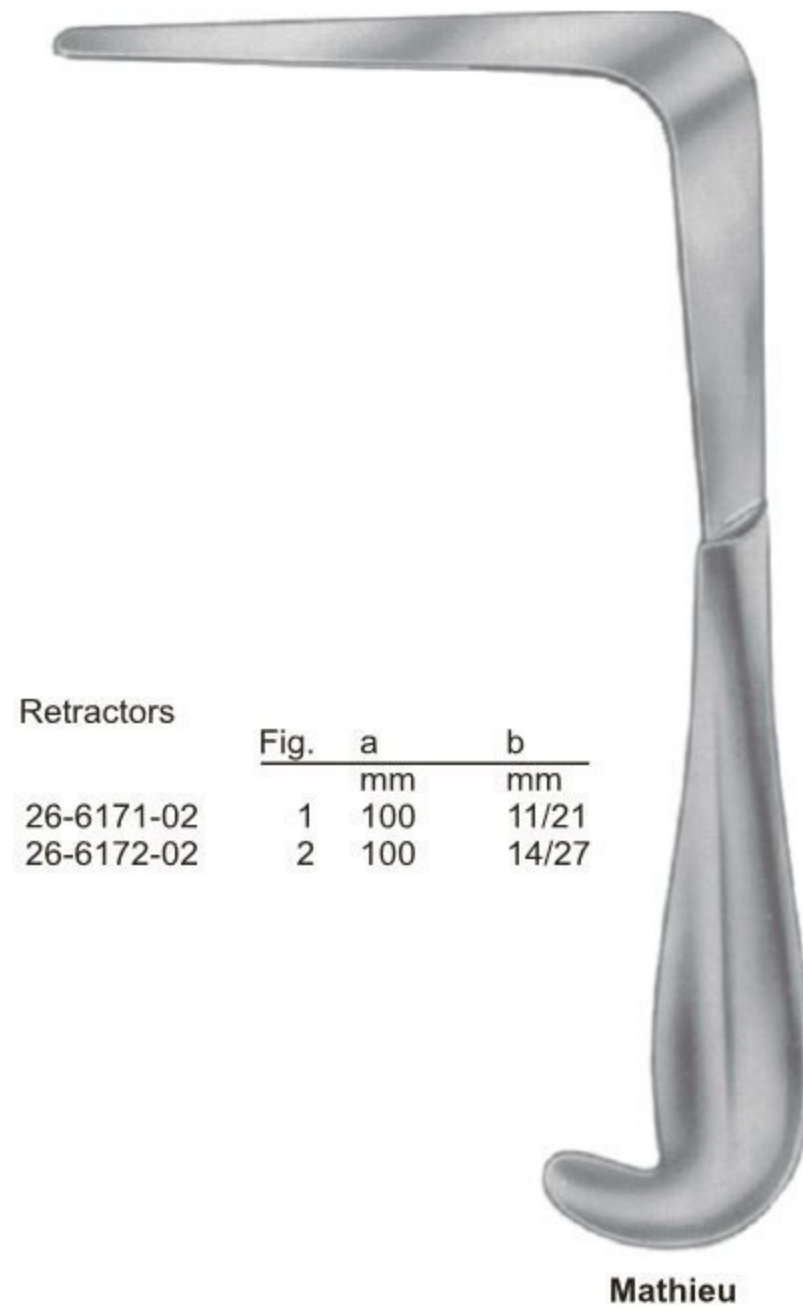

Retractors			
	Fig.	a	b
		mm	mm
26-6171-02	1	100	11/21
26-6172-02	2	100	14/27

Mathieu



	Fig.	a	b
		mm	mm
26-6173-01	1	75	45
26-6173-02	2	90	45
26-6173-03	3	110	45

Doyen



26-6174-01	75 x 280mm
26-6174-02	90 x 280mm
26-6174-03	100 x 280mm
26-6174-03	115 x 280mm

Doyen

Hollow handle 28cm/11"

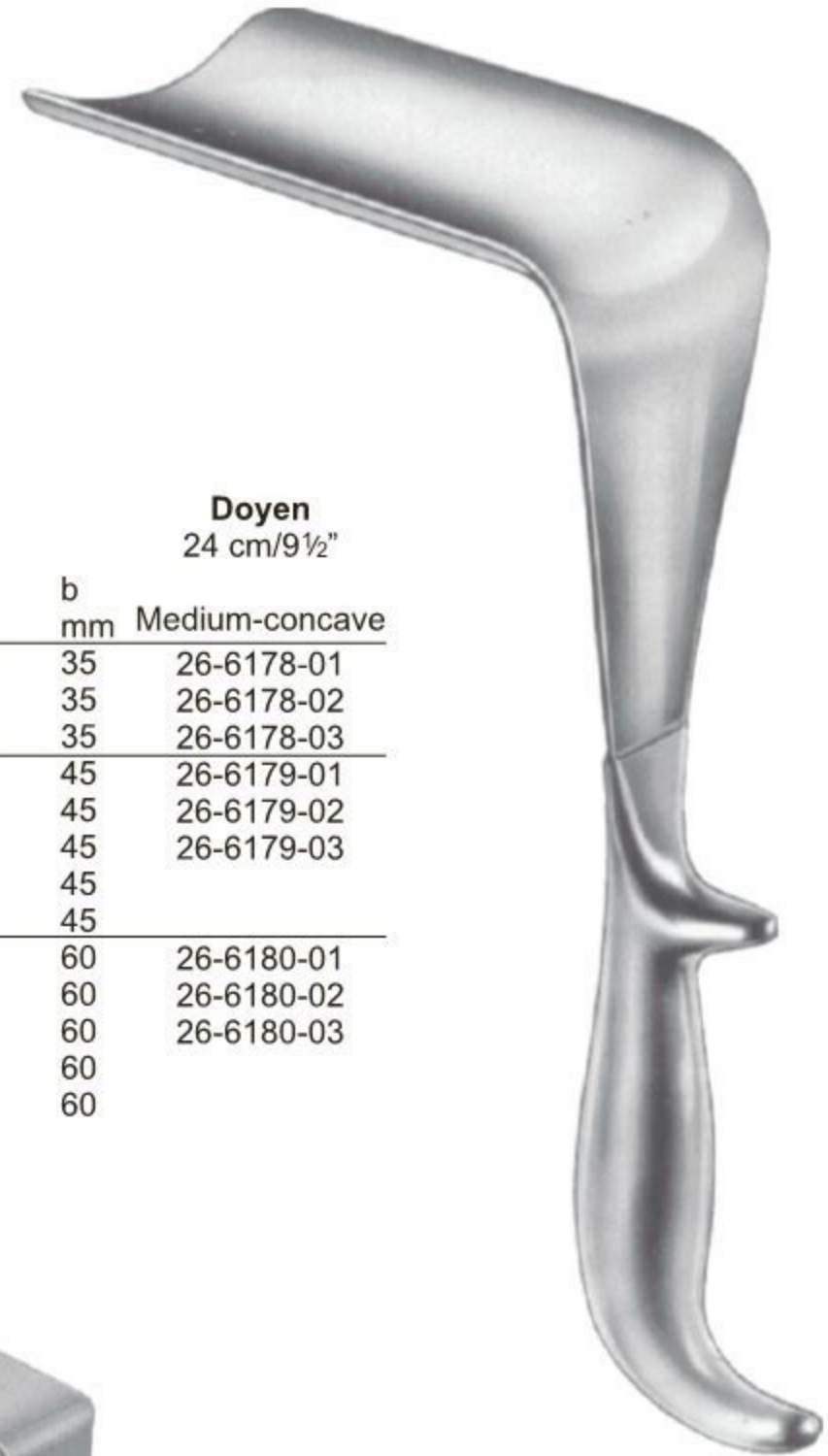

Doyen 24 cm/9 1/2"		Fig.	a mm	b mm	Doyen 24 cm/9 1/2"
slightly-concave					Medium-concave
26-6175-01	1	55	35	26-6178-01	
26-6175-02	2	85	35	26-6178-02	
26-6175-03	3	115	35	26-6178-03	
26-6176-01	1	55	45	26-6179-01	
26-6176-02	2	85	45	26-6179-02	
26-6176-03	3	115	45	26-6179-03	
26-6176-04	4	160	45		
26-6176-05	5	180	45		
26-6177-01	1	55	60	26-6180-01	
26-6177-02	2	85	60	26-6180-02	
26-6177-03	3	115	60	26-6180-03	
26-6177-04	4	160	60		
26-6177-05	5	180	60		



Doyen
25 cm/10"

	a mm	b mm
26-6181-01	60	30
26-6181-02	70	30
26-6181-03	80	30



Auvard
 with removable weight
 26-6182-01
 80x38 mm
 26-6182-02
 105x42 mm



Auvard
 with fixed weight
 26-6183-01
 70x38 mm
 26-6183-02
 102x45 mm



Landau

	a mm	b mm
26-6184-01	100	28
26-6184-02	100	38



Breisky

	a mm	b mm
26-6185-20	100	20
26-6185-25	100	25
26-6185-30	100	30
26-6185-35	100	35
26-6185-40	100	40
26-6186-20	130	20
26-6186-25	130	25
26-6186-30	130	30
26-6186-35	130	35
26-6186-40	130	40
26-6187-20	160	20
26-6187-25	160	25
26-6187-30	160	30
26-6187-35	160	35
26-6187-40	160	40
26-6188-20	180	20
26-6188-25	180	25
26-6188-30	180	30
26-6188-35	180	35
26-6188-40	180	40



Gelpi
 Vulva self retaining
 26-6189-20 20cm/8"



Comyn Berkeley
 Vulva self retaining
 26-6190-15 15.5cm/6"

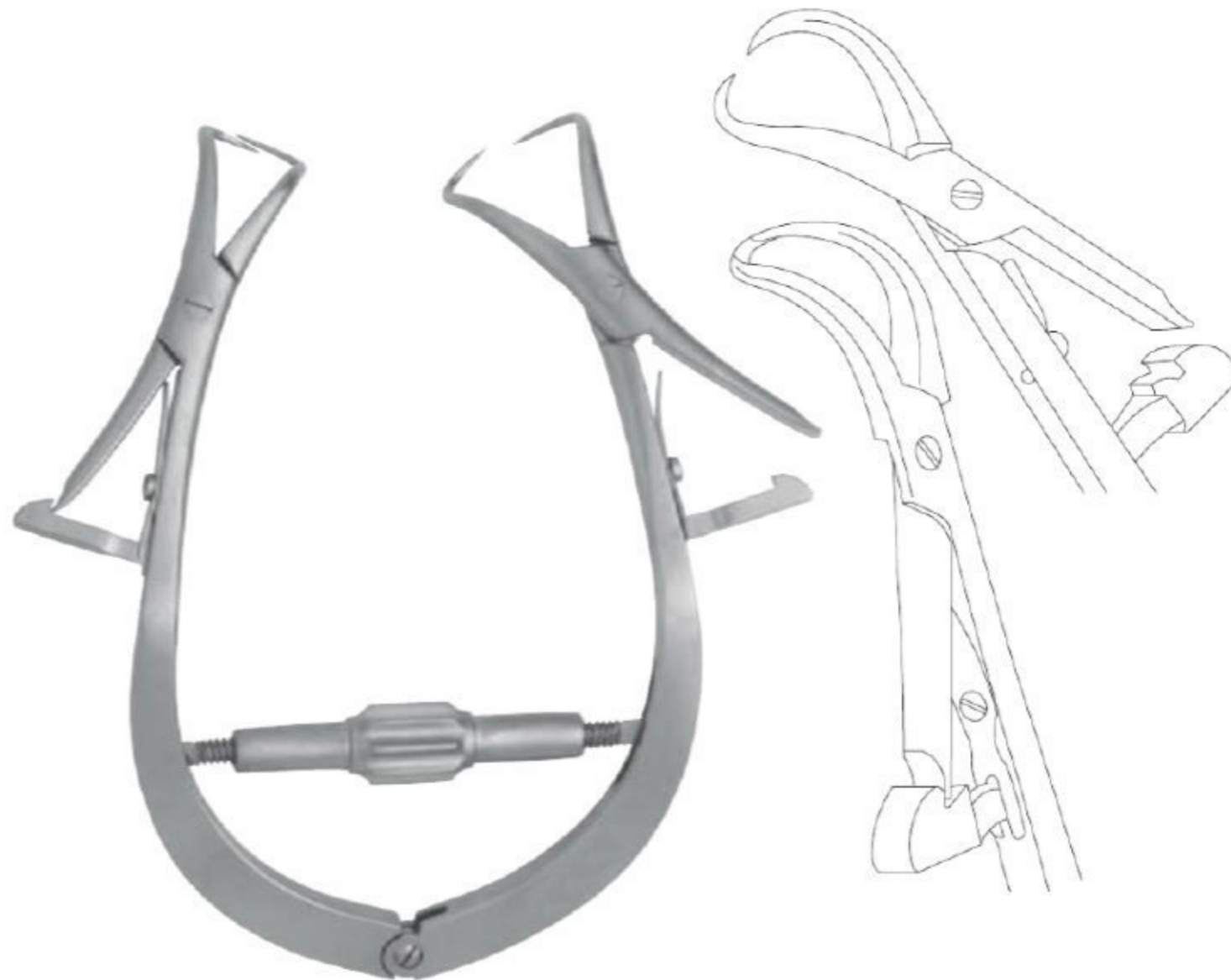

Joll
 Thyroid self retaining
 26-6191-15 15.5cm/6"

Lateral Wall Retractors ● EN
Wundspreizer ● DE
Separadores ● ES

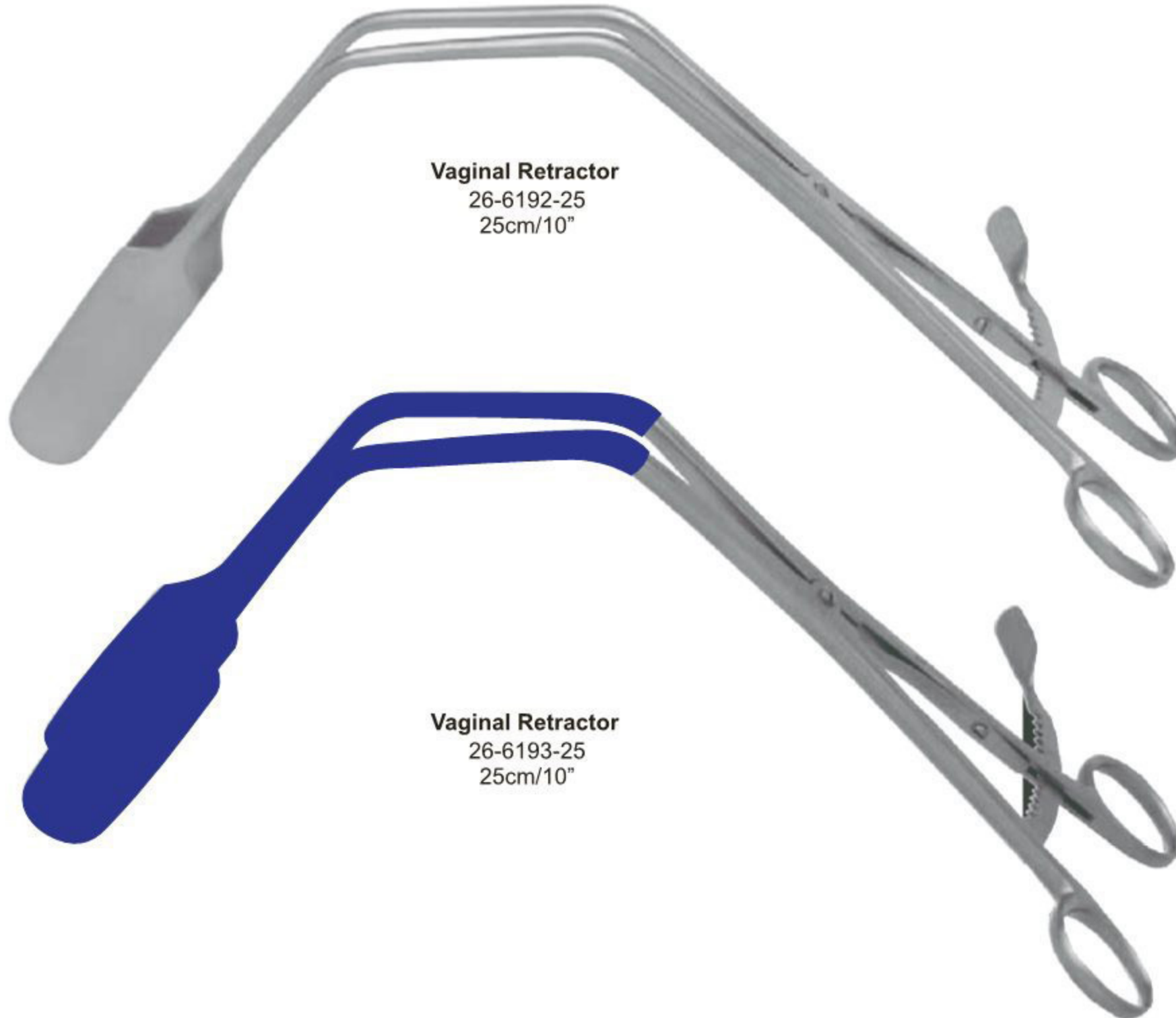
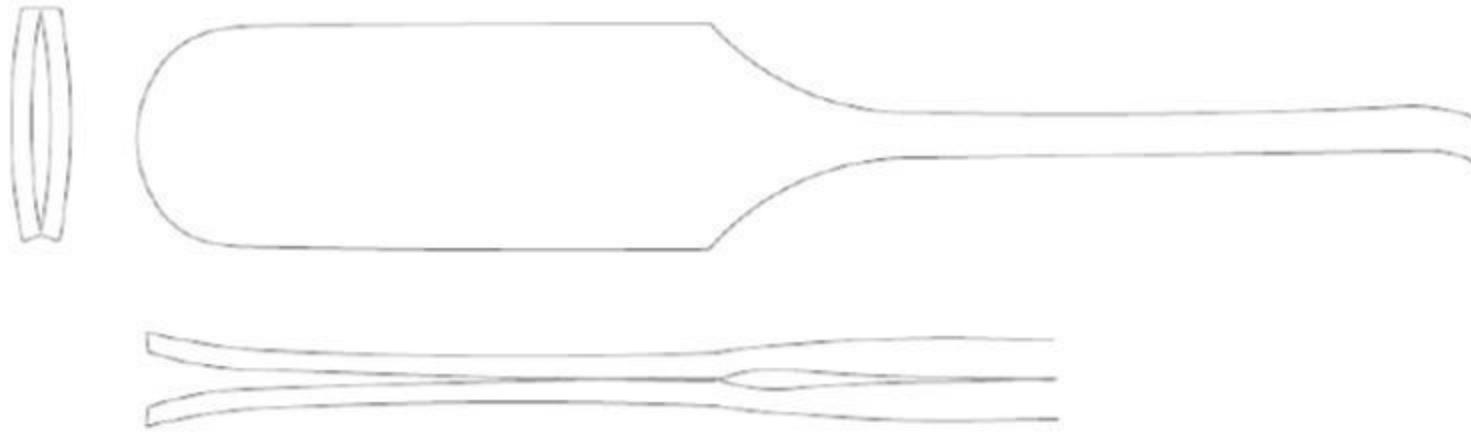

Vaginal Retractor
26-6192-25
25cm/10"

Vaginal Retractor
26-6193-25
25cm/10"



Scherbak
 26-6194-00

Complete



26-6194-01
 80x30 mm



26-6194-02
 85x35 mm



26-6194-03
 90x40 mm



26-6194-04
 55x40/60 mm



26-6194-05
 70x45/70 mm



	Fig.	a mm	b mm
26-6195-01	1	45	17
26-6195-02	2	90	37
26-6195-03	3	90	45



O'Sullivan-O'Connor
 26-6195-00
 Complete

Uterine Dilators ● EN
 Uterus-Dilatatoren ● DE
 Dilataores uterinos ● ES



Hegar
 single ended
 18.5 cm long

mmØ	
2.0	26-6196-02
3.0	26-6196-03
4.0	26-6196-04
5.0	26-6196-05
6.0	26-6196-06
7.0	26-6196-07
8.0	26-6196-08
9.0	26-6196-09
10.0	26-6196-10
11.0	26-6196-11
12.0	26-6196-12
13.0	26-6196-13
14.0	26-6196-14
15.0	26-6196-15
16.0	26-6196-16
17.0	26-6196-17
18.0	26-6196-18
19.0	26-6196-19
20.0	26-6196-20
21.0	26-6196-21
22.0	26-6196-22
23.0	26-6196-23
24.0	26-6196-24
25.0	26-6196-25
26.0	26-6196-26

Pieces per set

26-6197-50	12	3 - 14 mm
26-6198-60	25	2 - 26 mm



Hegar
 double ended
 20 cm long

Ø mm	
1/2	26-6199-02
3/4	26-6199-04
5/6	26-6199-06
7/8	26-6199-08
9/10	26-6199-10
11/12	26-6199-12
13/14	26-6199-14
15/16	26-6199-16
17/18	26-6199-18
19/20	26-6199-20
21/22	26-6199-22
23/24	26-6199-24
25/26	26-6199-26

Pieces per set		set
26-6200-00	08	3/4 - 17/18 mm
26-6200-00	12	1/2 - 23/24 mm

EN —● Uterine Dilators
 DE —● Uterus-Dilatatoren
 ES —● Dilatadores uterinos



mm	
3/6	26-6202-03
4/7	26-6202-04
5/8	26-6202-05
6/9	26-6202-06
7/10	26-6202-07
8/11	26-6202-08
9/12	26-6202-09
10/13	26-6202-10
11/14	26-6202-11
12/15	26-6202-12
13/16	26-6202-13
14/17	26-6202-14
15/18	26-6202-15
16/19	26-6202-16
17/20	26-6202-17
18/21	26-6202-18

Hawkin Ambler
 26-6201-16
 17 cm long
 set of 16 3/6 - 18/21



Hank
 26-6203-30

mm	
9/10	26-6204-10
11/12	26-6204-12
13/14	26-6204-14
15/16	26-6204-16
17/18	26-6204-18
19/20	26-6204-20

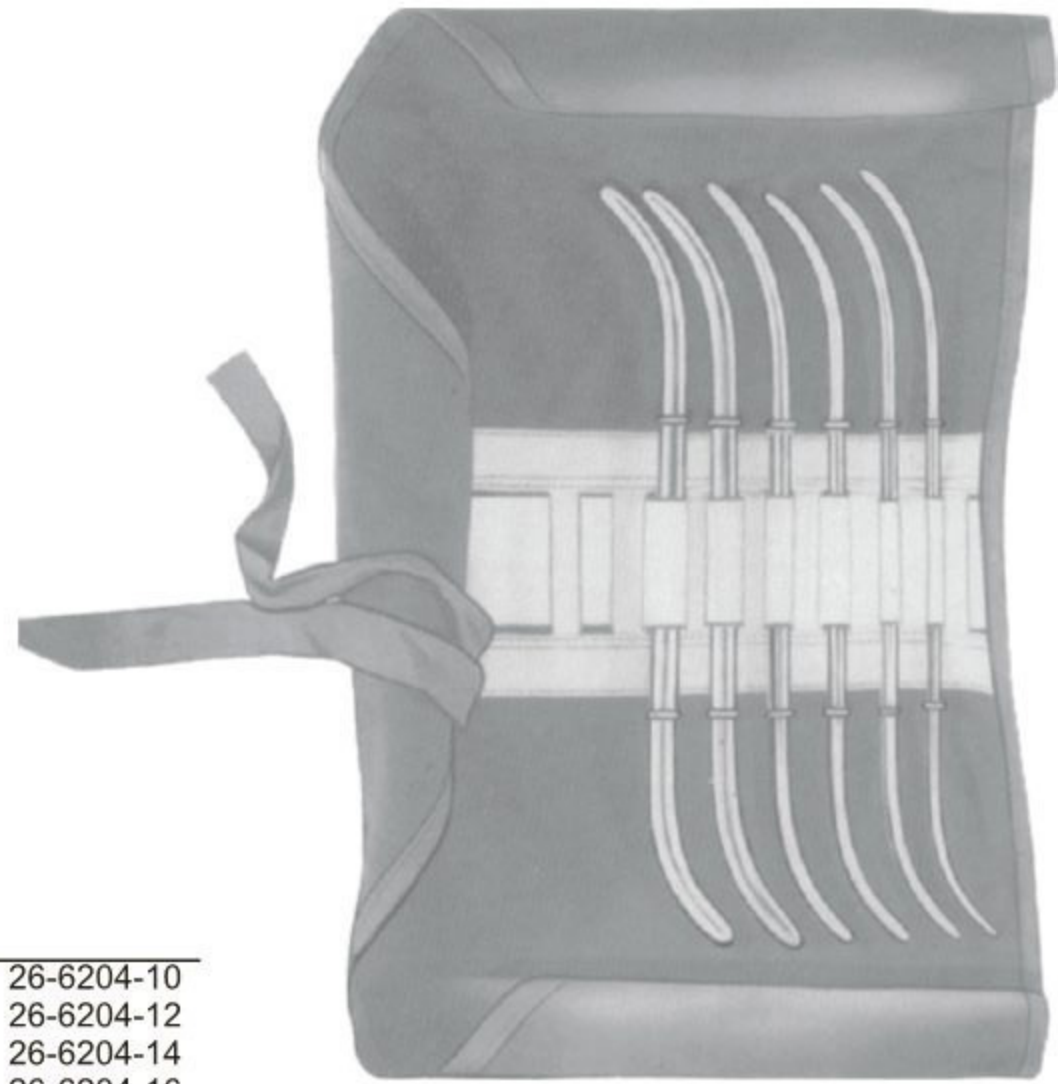

Set
 26-6205-00
 double ended
 27 cm



Pratt

mm	
13/15	26-6206-15
17/19	26-6206-19
21/23	26-6206-23
25/27	26-6206-27
29/31	26-6206-31
33/35	26-6206-35
37/39	26-6206-39
41/43	26-6206-43

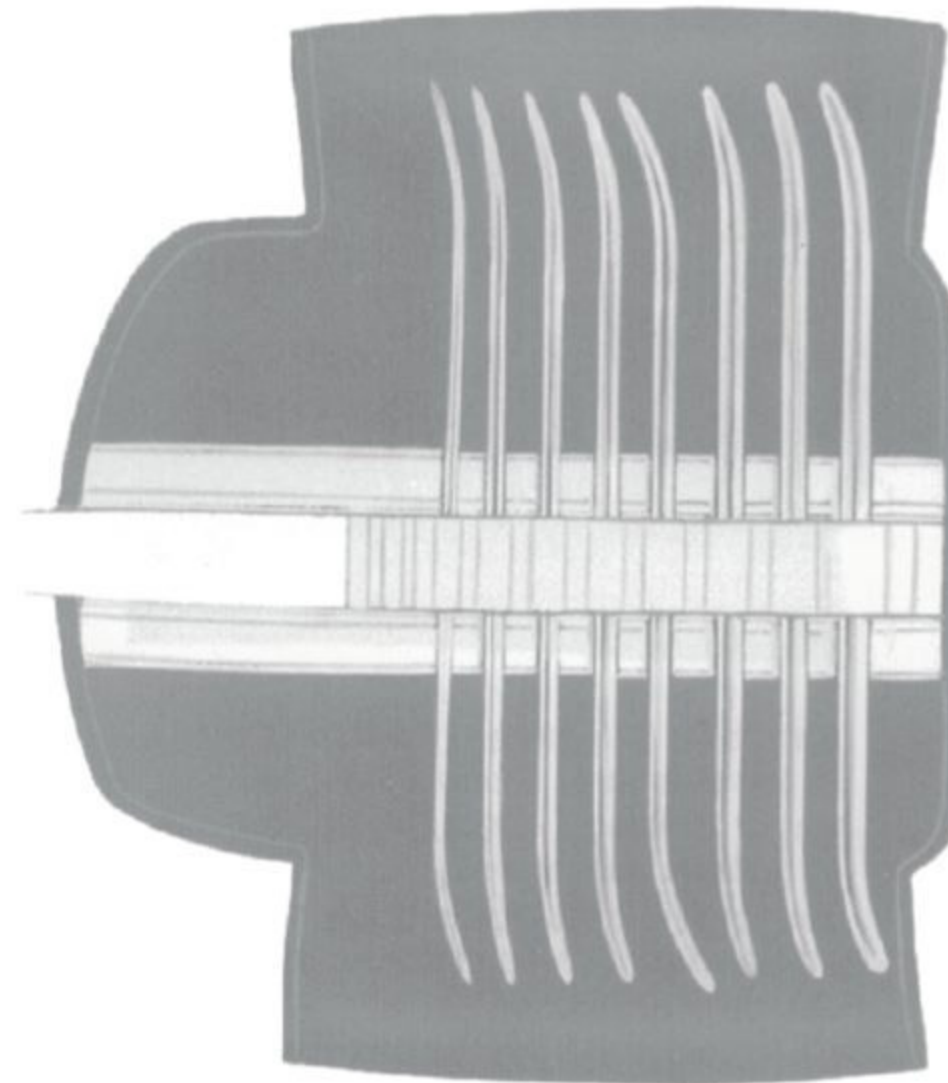

Set
 26-6207-00
 double ended
 29 cm

Tip 4 mm

Uterine Depressor



Sims
 32 cm/12½"

Martin (Simpson)
 32 cm/12½"

Valleix
 26-6214-25
 25 cm/10"

Collin
 26-6215-28
 28 cm/11"

Braun
 26-6216-28
 28 cm/11"

Rigid	cm	cm
	26-6208-32	26-6211-32

Malleable	cm / in	cm / in
	26-6209-32	26-6212-32
	26-6210-32	26-6213-32

Laser Probes



26-6217-01



90°

26-6217-02



45°

26-6217-03



20°

Measuring Probe



26-6218-01

Laser Probe



26-6219-01



90°

26-6219-02



45°

26-6219-03



20°

Depth Ruler



26-6220-01

Measuring Instruments

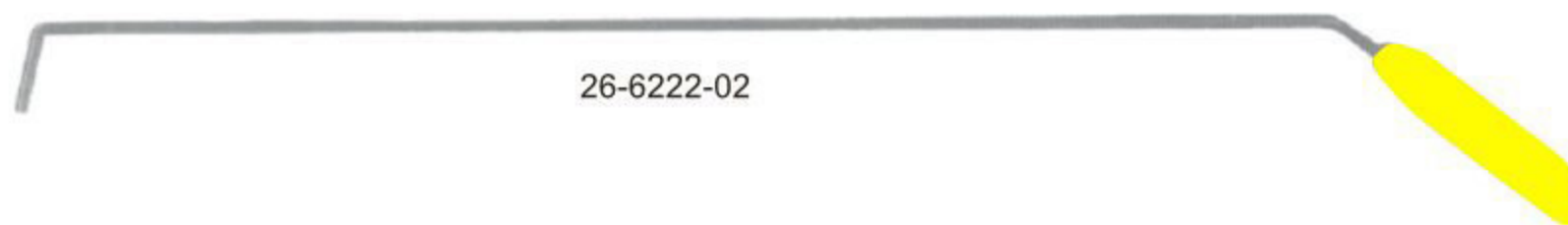

Hooks



- EN —● Corn Knives, Fistula Hooks, Myoma Instruments
- DE —● Konusmesser, Fistelhaken, Myom-instrumente
- ES —● Bisturí p. conos de atraccion, Ganchos p. fistulas, instrumentos para fibroma



Ayre
 26-6228-23
 23 cm/9"



Simon
 26-6229-22
 22 cm/8¾"



Simon
 26-6230-22
 22 cm/8¾"



Emmet
 22 cm/8¾"



26-6231-01



26-6231-02



26-6231-03



26-6231-04



26-6231-05



Doyen
 26-6232-17
 17 cm/6¾"



Doyen
 26-6233-17
 17 cm/6¾"



Segond
 26-6234-27
 27 cm/10½"

Suction Biopsy Currettes ● EN
 Saug- und Biopsieküretten ● DE
 Curetas aspiradoras para biopsia ● ES

Secretion Spoon



26-6235-27
 27 cm/10½"



Muenchen
 27 cm/10½"



26-6236-04
 4 mm



26-6236-05
 5 mm



Randall
 26-6237-24
 24 cm/9½"

4 mmØ



Novak
 23 cm/9"

- 26-6238-01
1 mm
- 26-6238-02
2 mm
- 26-6238-03
3 mm
- 26-6238-04
4 mm



Novak-Schoeckaert
 26-6239-24
 24 cm/9"



Kevorkian
 26-6240-30
 30 cm/12"

malleable
 26-6241-30
 30 cm/12"



Kevorkian
 26-6242-30
 30 cm/12"

malleable
 26-6243-30
 30 cm/12"



Townsend
 26-6244-30
 31 cm/12¼"

malleable
 26-6245-30
 31 cm/12¼"



Duncan
 26-6246-31
 31 cm/12¼"



Duncan
 26-6247-31
 31 cm/12¼"



Goodell
 26-6248-34
 34 cm/13½"



Kogan-Laser
 28 cm/11"



26-6251-28
 28 cm/11"



Kogan
 26-6252-24
 24 cm/9½"

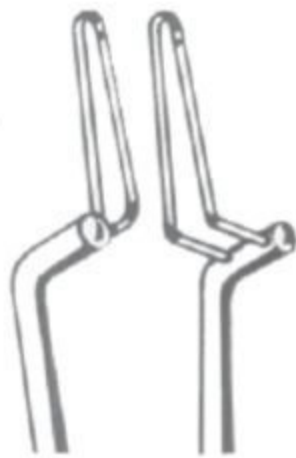

Kogan
 26-6253-24
 24 cm/9½"



Kogan
 28 cm/11"





Martin
 26-6256-27
 27 cm/10½"



Staude-Moore
 26-6257-17
 17 cm/6¾"



Barrett
 26-6258-18
 18 cm/7"



Schroeder
 26-6259-25
 25 cm/10"



Braun
 26-6260-25
 25 cm/10"



Collin-Pozzi
 26-6261-25
 25 cm/10"



Pozzi
 26-6262-25
 25.5 cm/10¼"

Strong Pattern



Duplay
 26-6263-28
 28 cm/11"

Tenaculum Forceps ● EN
 Hakenzangen ● DE
 Pinzas para coger el cuello del útero ● ES



Skene
 26-6264-24
 24 cm/9½"

Amniotome for the
 amnion Bladder



Beacham
 26-6265-26
 26 cm/10¼"



Czerny
 26-6266-20
 20.5 cm/8¼"



26-6267-26
 26 cm/10¼"



Schroeder
 26-6268-20 20 cm/8"
 26-6268-24 24 cm/9½"

Straight



Schroeder
 26-6269-20
 26-6269-24

Curved on Flat



Schroeder
 26-6270-20
 26-6270-24

Curved Sideway

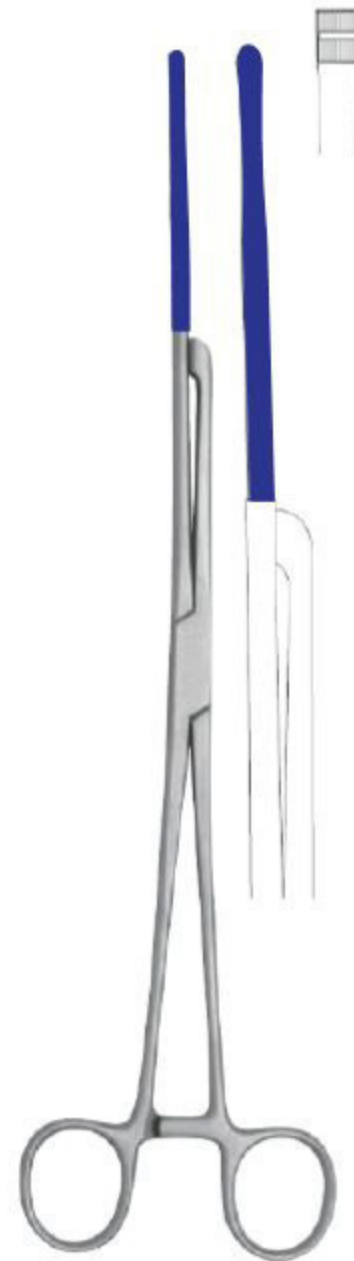

Atrauma
 26-6271-29
 Vulsellum Forcep
 29cm/11 ½"

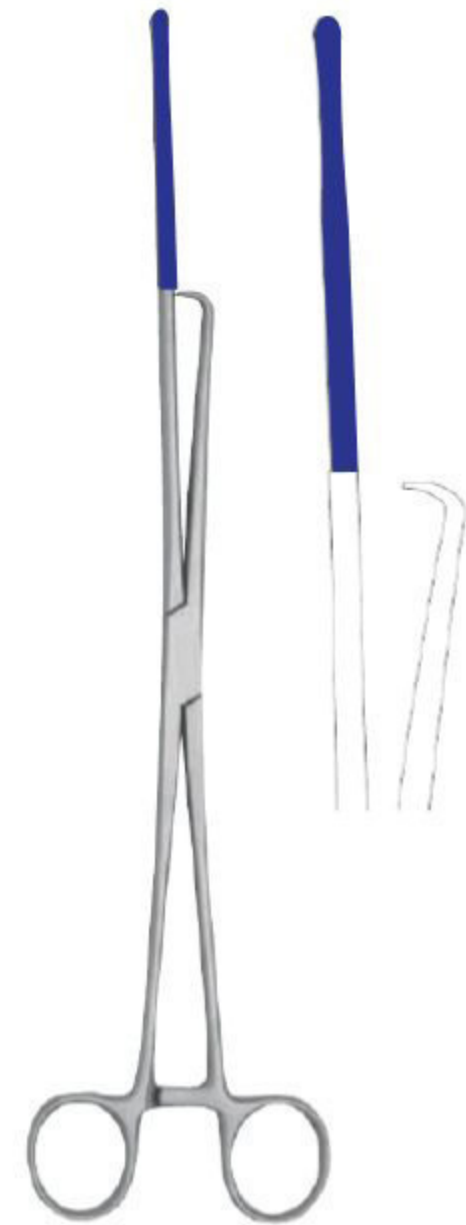

Luer
 26-6272-30
 Vulsellum Forcep
 30.5cm/12"



Atrauma
 26-6273-29
 29cm/11 1/2"



Bozeman
 26-6274-27
 27cm/10 1/2"



26-6275-23
 23cm/9"
 jaw 1/8"

26-6276-23
 23cm/9"
 jaw 1/4"



Rotunda
 26-6277-27
 27cm/10 1/2"



Bierer
 26-6278-24
 24cm/9 1/2"



Straight
 26-6279-06
 26-6279-08
 26-6279-10



Museux
 24 cm/9 1/2"
 06 mm
 08 mm
 10 mm



Curved Sideway
 26-6280-06
 26-6280-08
 26-6280-10



Straight
 26-6281-06
 26-6281-08
 26-6281-10



Museux
 24 cm/9 1/2"
 06 mm
 08 mm
 10 mm



Curved Sideway
 26-6282-06
 26-6282-08
 26-6282-10



Braun
 26-6283-16
 16 cm/6 1/4"

Tenaculum Forceps ●— EN
 Hakenzangen ●— DE
 Pinzas para coger el cuello del útero ●— ES

For the amnion Bladder



Pratt
 26-6284-28
 28 cm/11"



Teale
 26-6285-24
 24 cm/9½"



Iowa
 26-6286-26
 26 cm/10¼"



Jacobs
 Straight Curved Sideway
 26-6287-21 26-6288-21
 21 cm/8¼"



Bonney Polypus
 26-6289-26
 24 cm/9 ½"



Kelly
 26-6290-32
 32 cm/12½"



Heywood-Smith
 26-6291-20
 20 cm/8"



Heywood-Smith
 26-6292-25
 25 cm/10"



Noto
 26-6293-27
 27 cm/10½"

EN —● Uterine Elevating, Ovarian Forceps, Vaginal Clamps

DE —● Uterus-Faßzangen

ES —● Pinzas para el útero



Dartigues
 26-6294-27
 27 cm/10½"



Somer
 26-6295-23
 23 cm/9"



Collin
 26-6296-25
 25 cm/10"



Ovarian Forceps

Doyen
 26-6297-18 18 cm/7"
 26-6297-20 20 cm/8"



Bonney
 26-6298-34
 34.5 cm/13 ½"



Bonney
 26-6299-27
 27 cm/10½"



Bonney
 26-6300-20
 20 cm/8"
 curved



Bonney Berkley
 26-6301-20
 20 cm/8"
 angled



Gellhorn
 26-6302-23
 23 cm/9"



Thoms-Gaylor
 26-6303-24
 24 cm/9½"



Schubert
 26-6304-21 21 cm/8¼"
 26-6304-29 29 cm/11¼"



Schubert
 26-6305-26
 26 cm/10¼"



Tischler
 26-6306-27
 27 cm/10½"



Van Doren
 26-6307-25
 25 cm/10"



Gwilliam

26-6308-20 20cm/8"
 26-6309-20 20cm/8"



Hunter
 26-6310-23
 23 cm/9"

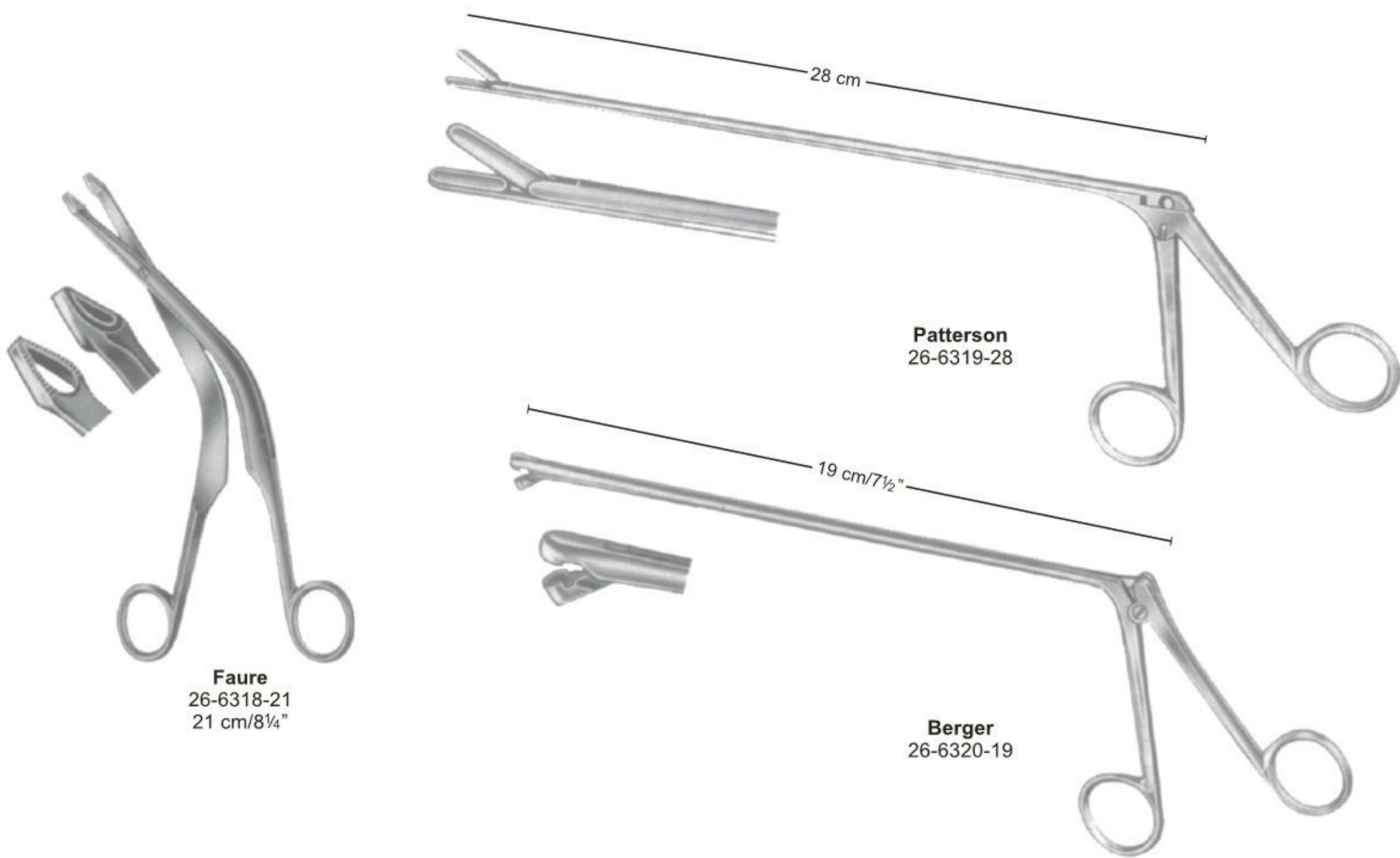
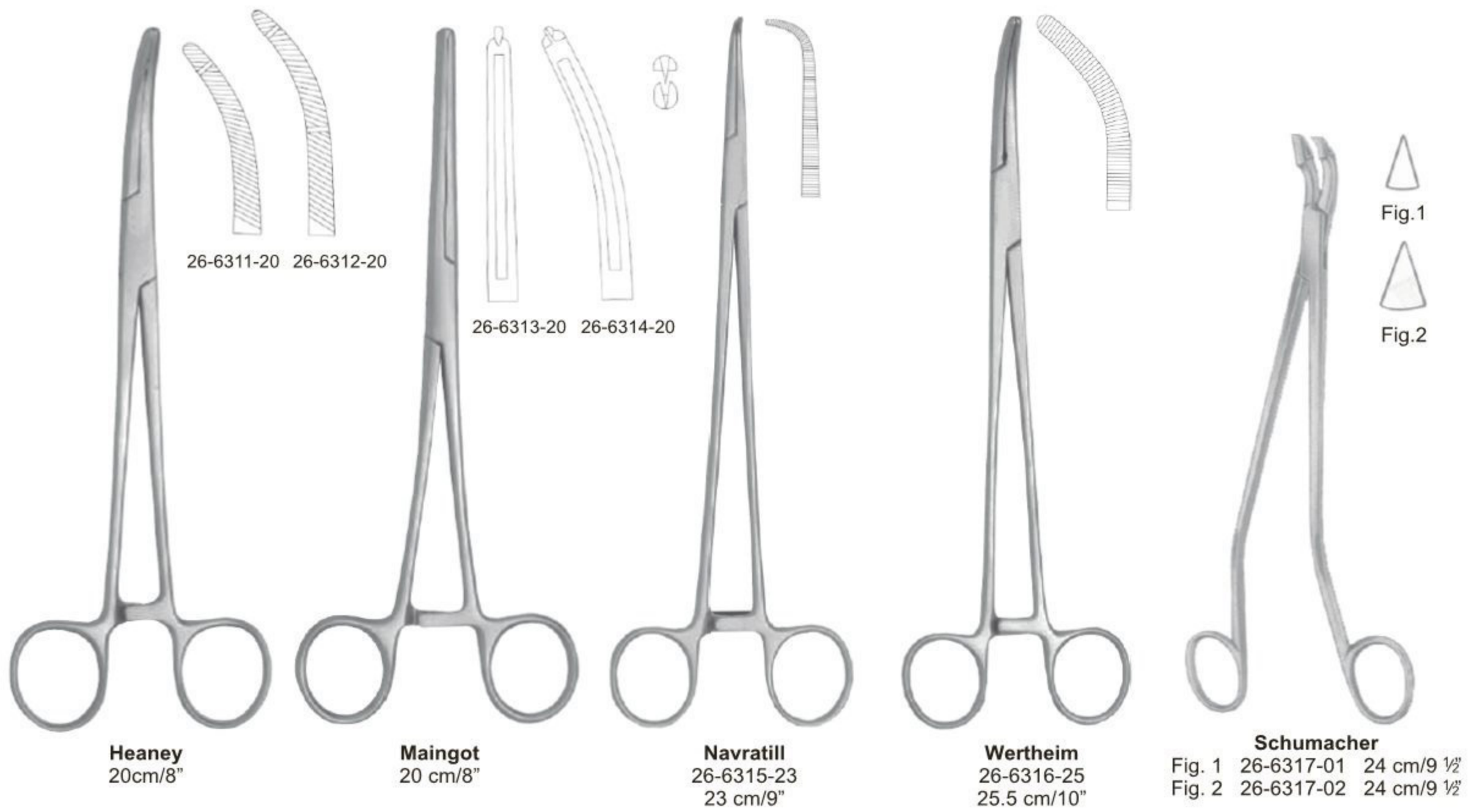



- 26-6321-20 L= 20 cm/8"
- 26-6321-25 L= 25 cm/10"
- 26-6321-30 L= 30 cm/12"
- 26-6321-35 L= 35 cm/14"
- 26-6321-40 L= 40 cm/16"



- 26-6323-04 4 mm
- 26-6323-06 6 mm

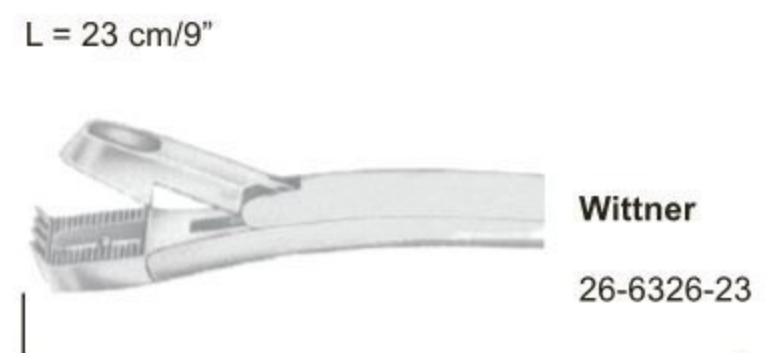

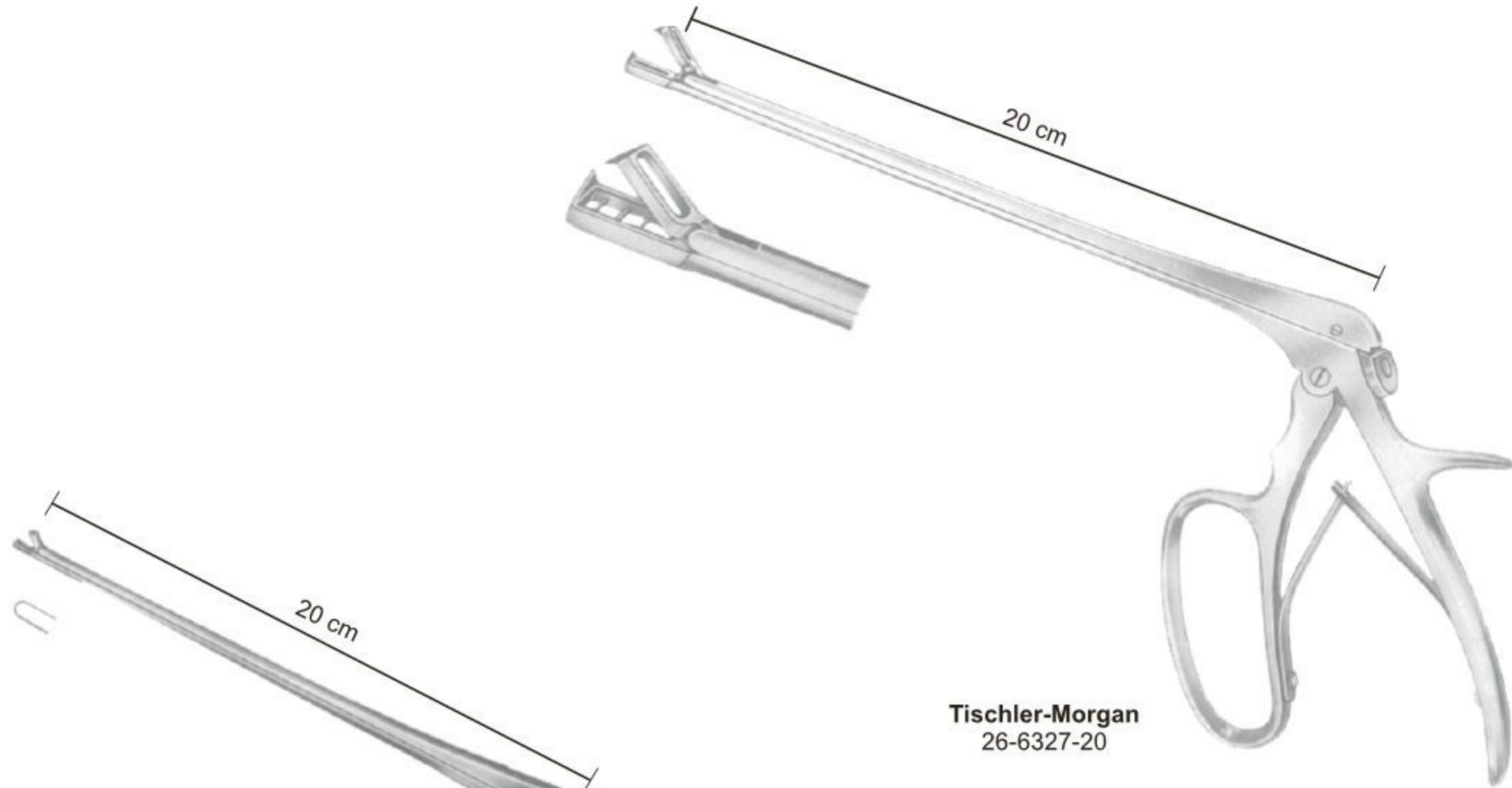

Tischler-Morgan
 26-6327-20



Baby-Tischler
 26-6328-20



Alexander
 26-6329-28

Cervical Biopsy and Specimen Forceps ● EN
 Probeexzisionszangen ● DE
 Pinzas saca-bocados para biopsia ● ES

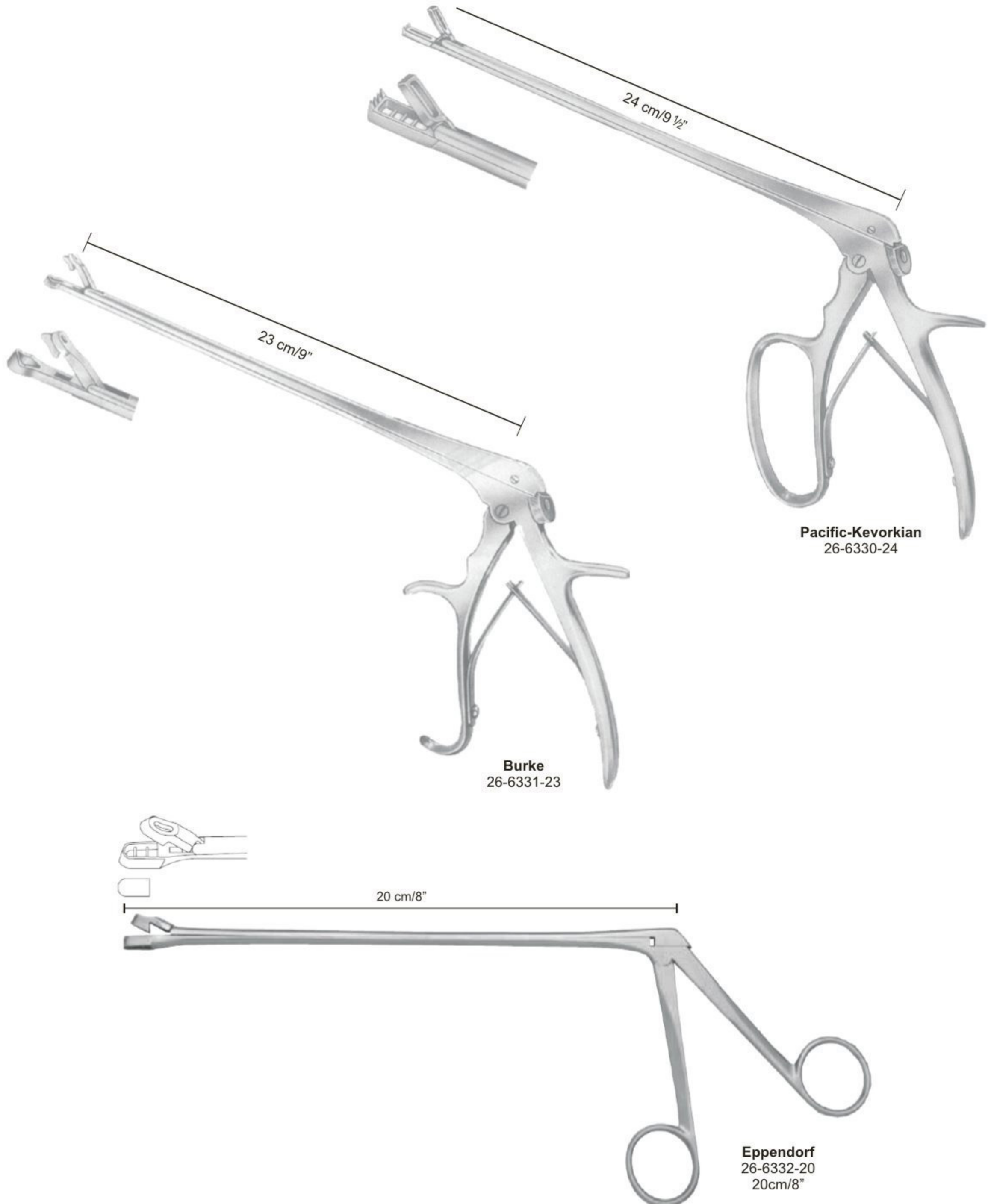











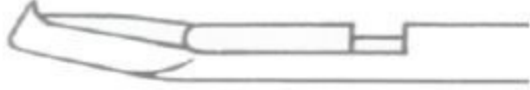

Townsend

Handle

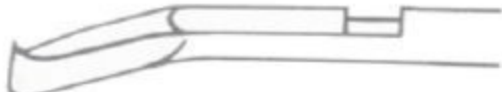

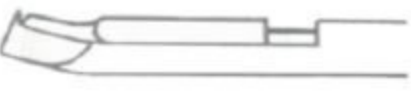
Tip with tube

		Complete instrument	Tip, only
	Tischler	26-6333-00	26-6334-01
	Kevorkian	26-6335-00	26-6336-01
	Mini-Townsend	26-6337-00	26-6338-01
 	Tischler-up	26-6339-00	26-6340-01
 	Tischler-down	26-6341-00	26-6342-01
 	Mini-Townsend-up	26-6343-00	26-6344-01
 	Mini-Townsend-down	26-6345-00	26-6346-01

Uterine Curettes ● EN
 Uterusküretten ● DE
 Curetas uterinas ● ES



Schroeder
 30 cm/12"

Sharp Rigid

Schroeder
 Simon



Fig. 1
 26-6347-01
 26-6348-01



Fig. 2
 26-6349-02
 26-6350-02



Fig. 3
 26-6351-03
 26-6352-03



Fig. 4
 26-6353-04
 26-6354-04



Fig. 5
 26-6355-05
 26-6356-05



Fig. 6
 26-6357-06
 26-6358-06

Schroeder
 Simon



Simon
 25 cm/10"



Gourdet
 28 cm/11"



Fig. 1
 26-6359-01
 6 mm



Fig. 2
 26-6359-02
 8 mm



Fig. 3
 26-6359-03
 10 mm



Fig. 4
 26-6359-04
 12 mm



Fig. 5
 26-6359-05
 14 mm



Thomas



Fig. 1
26-6360-01



Fig. 2
26-6360-02



Fig. 3
26-6360-03



Fig. 4
26-6360-04



Fig. 5
26-6360-05



Fig. 6
26-6360-06



Greene

26-6361-10
10 mm

26-6361-12
12 mm

26-6361-14
14 mm



Collin
26-6362-30
30 cm/12"



Heaney
26-6363-24
24 cm/9½"



Heaney
26-6364-24
24 cm/9½"

Aspirating Currettes ● EN
 Absaugkurren ● DE
 Curetas de aspiración ● ES



Milan
 28.5 cm/11¼"

Malleable



26-6365-05
 5 mm Ø



26-6367-07
 7 mm Ø



26-6369-09
 9 mm Ø

Rigid

26-6366-05
 5 mm Ø

26-6368-07
 7 mm Ø

26-6370-09
 9 mm Ø



28 cm/11"

- | | |
|------------|---------|
| | Ø |
| 26-6371-04 | 4.0 mm |
| 26-6371-06 | 6.0 mm |
| 26-6371-08 | 8.0 mm |
| 26-6371-10 | 10.0 mm |
| 26-6371-12 | 12.0 mm |
| 26-6371-14 | 14.0 mm |
| 26-6371-16 | 16.0 mm |

Hose Connecting Piece



26-6372-00

EN —● Uterine Curettes
 DE —● Uterusküretten
 ES —● Curetas uterinas

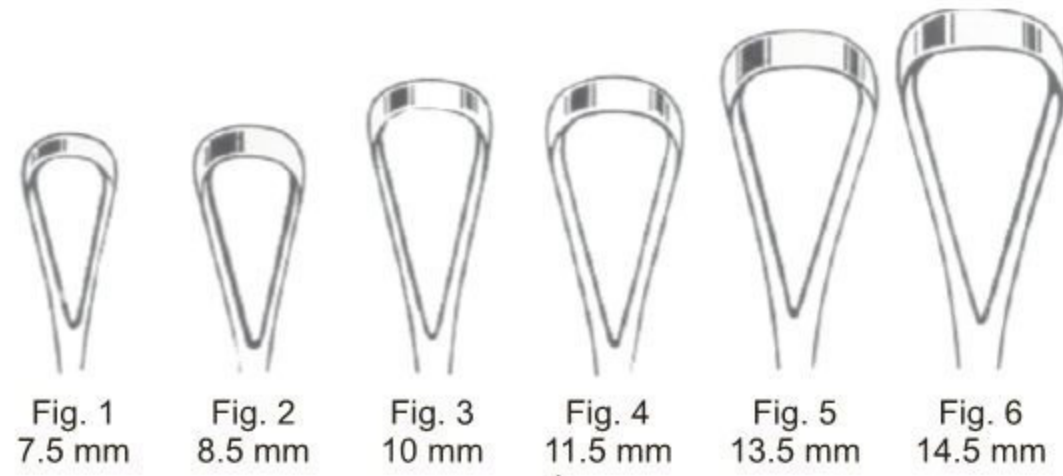

		Malleable		Rigid	
		Sharp	Blunt	Sharp	Blunt
Fig. 1	26-6373-01	26-6374-01		26-6375-01	26-6376-01
Fig. 2	26-6373-02	26-6374-02		26-6375-02	26-6376-02
Fig. 3	26-6373-03	26-6374-03		26-6375-03	26-6376-03
Fig. 4	26-6373-04	26-6374-04		26-6375-04	26-6376-04
Fig. 5	26-6373-05	26-6374-05		26-6375-05	26-6376-05
Fig. 6	26-6373-06	26-6374-06		26-6375-06	26-6376-06

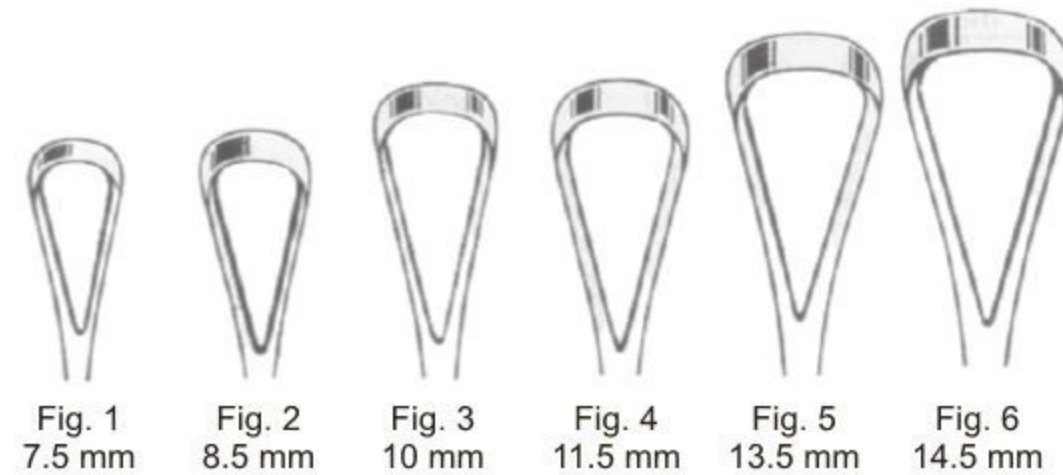

		Malleable		Rigid	
		Sharp	Blunt	Sharp	Blunt
Fig. 1	26-6377-01	26-6378-01		26-6379-01	26-6380-01
Fig. 2	26-6377-02	26-6378-02		26-6379-02	26-6380-02
Fig. 3	26-6377-03	26-6378-03		26-6379-03	26-6380-03
Fig. 4	26-6377-04	26-6378-04		26-6379-04	26-6380-04
Fig. 5	26-6377-05	26-6378-05		26-6379-05	26-6380-05
Fig. 6	26-6377-06	26-6378-06		26-6379-06	26-6380-06

Uterine Curettes ●— EN
 Uterusküretten ●— DE
 Curetas uterinas ●— ES

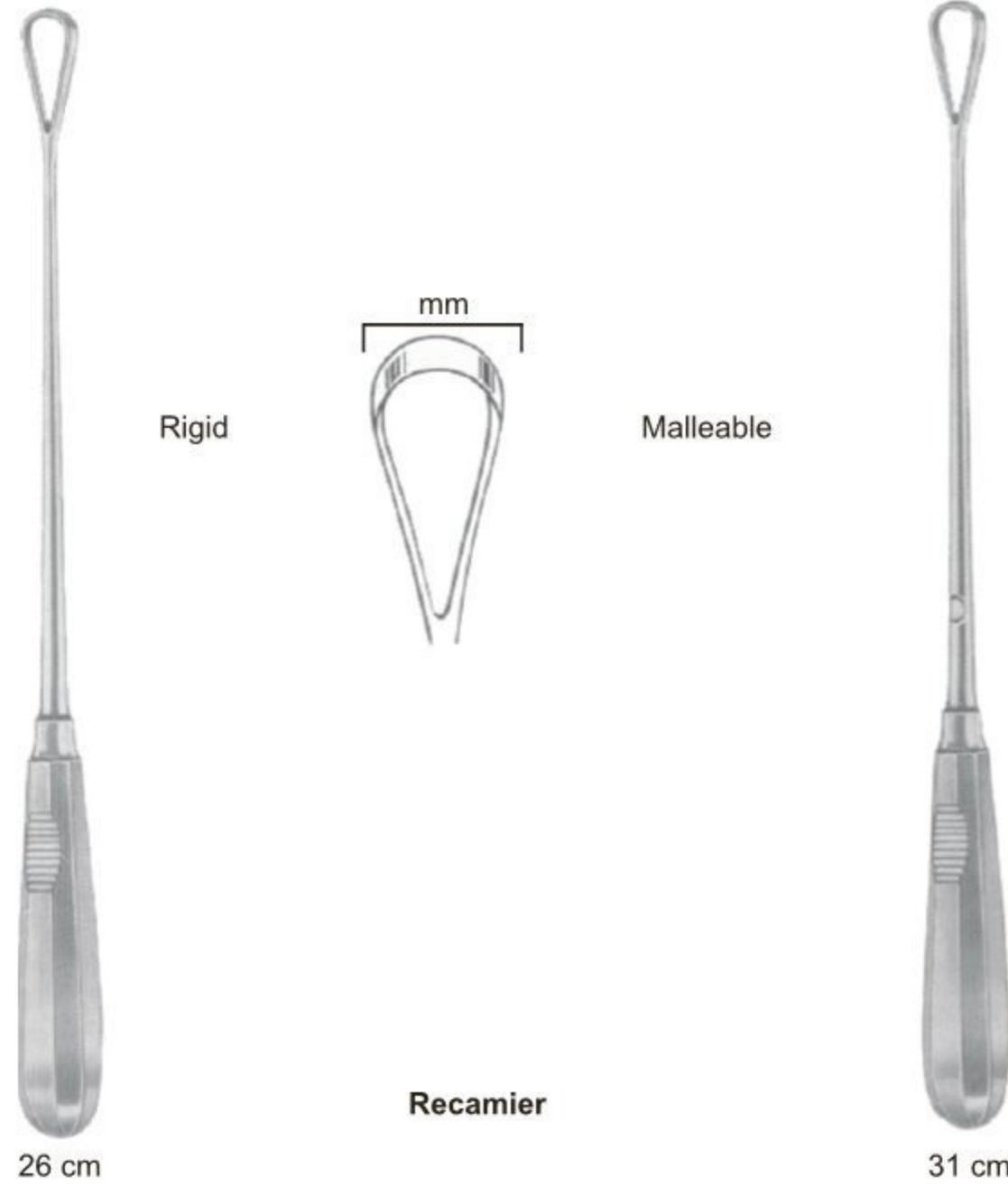

Fig.	mm	Malleable		Rigid		Malleable		Rigid	
		Sharp	Blunt	Sharp	Blunt	Sharp	Blunt	Sharp	Blunt
00	5	26-6381-05	26-6382-05	26-6383-05	26-6384-05	26-6385-05	26-6386-05	26-6387-05	26-6388-05
0	6	26-6381-06	26-6382-06	26-6383-06	26-6384-06	26-6385-06	26-6386-06	26-6387-06	26-6388-06
1	7	26-6381-07	26-6382-07	26-6383-07	26-6384-07	26-6385-07	26-6386-07	26-6387-07	26-6388-07
2	8	26-6381-08	26-6382-08	26-6383-08	26-6384-08	26-6385-08	26-6386-08	26-6387-08	26-6388-08
3	9	26-6381-09	26-6382-09	26-6383-09	26-6384-09	26-6385-09	26-6386-09	26-6387-09	26-6388-09
4	10	26-6381-11	26-6382-11	26-6383-11	26-6384-11	26-6385-11	26-6386-11	26-6387-11	26-6388-11
5	12	26-6381-12	26-6382-12	26-6383-12	26-6384-12	26-6385-12	26-6386-12	26-6387-12	26-6388-12
6	14	26-6381-14	26-6382-14	26-6383-14	26-6384-14	26-6385-14	26-6386-14	26-6387-14	26-6388-14
7	15	26-6381-15	26-6382-15	26-6383-15	26-6384-15	26-6385-15	26-6386-15	26-6387-15	26-6388-15
8	16	26-6381-16	26-6382-16	26-6383-16	26-6384-16	26-6385-16	26-6386-16	26-6387-16	26-6388-16
9	19	26-6381-19	26-6382-19	26-6383-19	26-6384-19	26-6385-19	26-6386-19	26-6387-19	26-6388-19
10	20	26-6381-20	26-6382-20	26-6383-20	26-6384-20	26-6385-20	26-6386-20	26-6387-20	26-6388-20
11	21	26-6381-21	26-6382-21	26-6383-21	26-6384-21	26-6385-21	26-6386-21	26-6387-21	26-6388-21
12	23	26-6381-23	26-6382-23	26-6383-23	26-6384-23	26-6385-23	26-6386-23	26-6387-23	26-6388-23
13	25					26-6385-25	26-6386-25	26-6387-25	26-6388-25
14	30					26-6385-30	26-6386-30	26-6387-30	26-6388-30
15	35					26-6385-35	26-6386-35	26-6387-35	26-6388-35
16	40					26-6385-40	26-6386-40	26-6387-40	26-6388-40



Bumm
 max. 29 cm/11½"

Fig.	mm	Mealleable	
		Sharp	Blunt
0	16.0	26-6389-16	26-6390-16
1	18.0	26-6389-18	26-6390-18
2	19.5	26-6389-19	26-6390-19
3	21.5	26-6389-21	26-6390-21
4	23.5	26-6389-23	26-6390-23
5	26.0	26-6389-26	26-6390-26
6	28.5	26-6389-28	26-6390-28



Blunt

Sharp

Blake (Zweifel)
 26-6391-27 27 cm/10½"
 26-6391-31 31 cm/12¼"

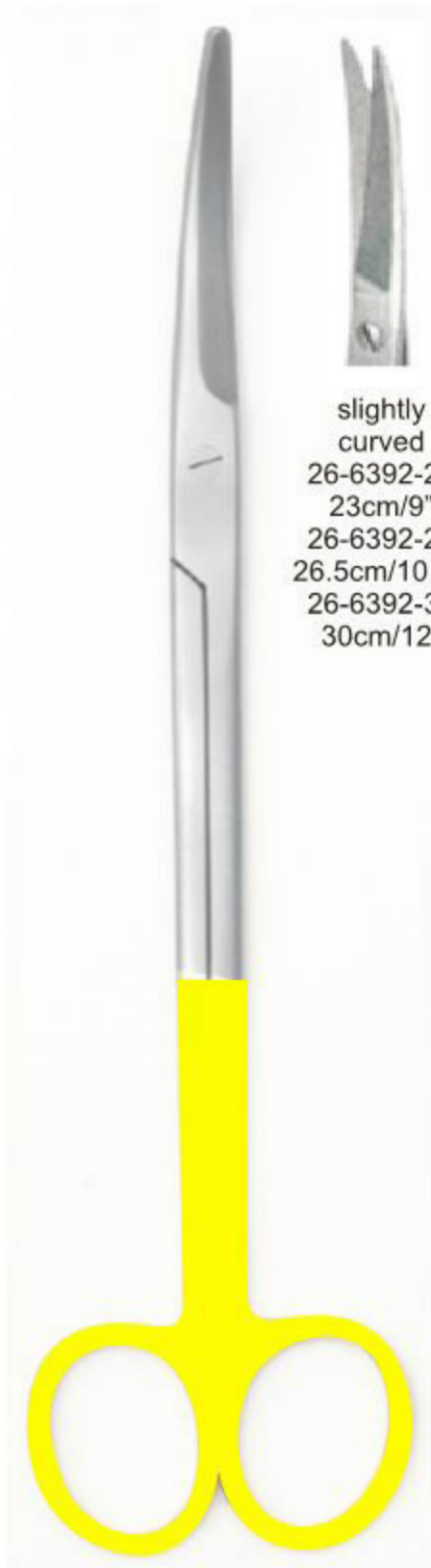

Zeppelin Scissor
with TC

slightly curved
 26-6392-23
 23cm/9"
 26-6392-26
 26.5cm/10 1/2"
 26-6392-30
 30cm/12"

curved
 26-6393-23
 23cm/9"
 26-6393-26
 26.5cm/10 1/2"
 26-6393-30
 30cm/12"

Fully curved
 26-6394-23
 23cm/9"
 26-6394-26
 26.5cm/10 1/2"
 26-6394-30
 30cm/12"

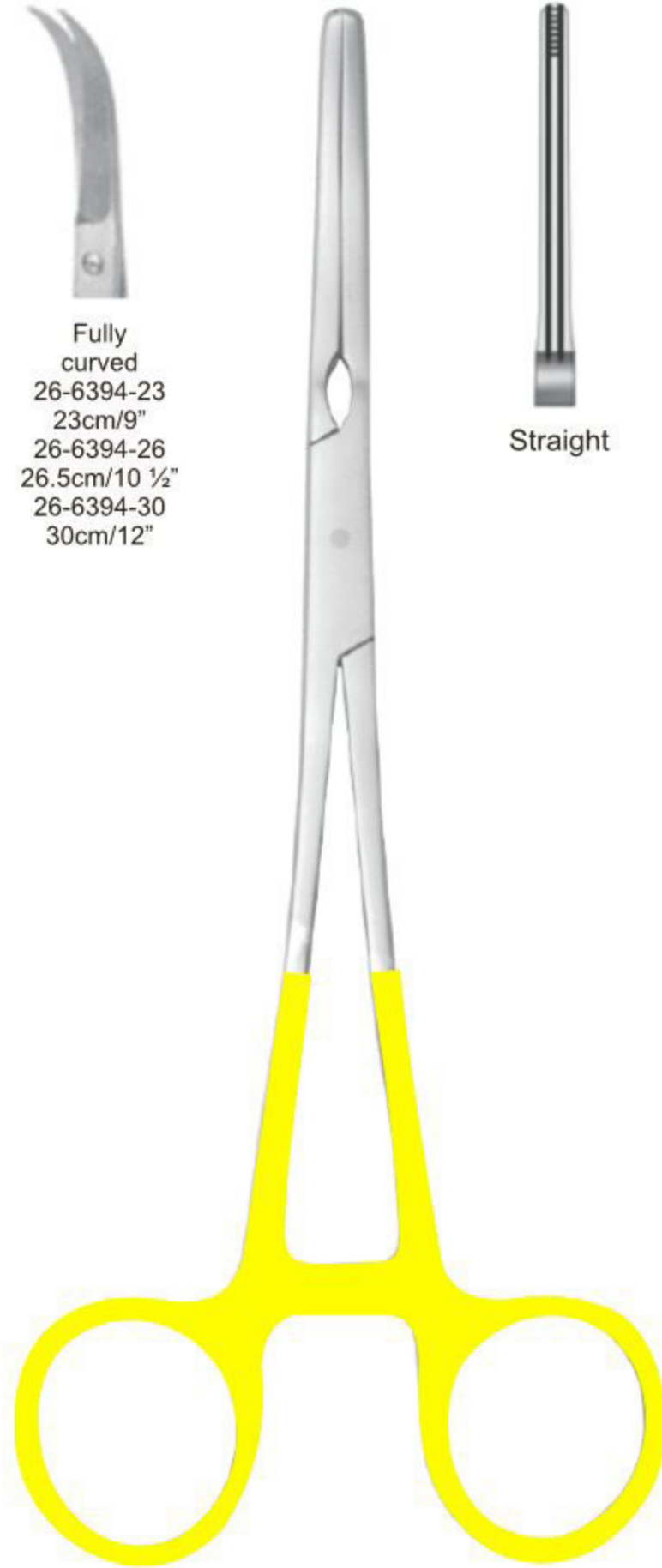

Zeppelin Clamps
offset handle with gold rings (without TC)

Straight	26-6395-21	26-6399-24	26-6403-30	26-6407-35
Slightly Curved	26-6396-21	26-6400-24	26-6404-30	26-6408-35
Strongly Curved	26-6397-21	26-6401-24	26-6405-30	26-6409-35
Angled	26-6398-21	26-6402-24	26-6406-30	26-6410-35
	21.5cm/8 1/2"	24cm/9 1/2"	30cm/12"	35cm/14"

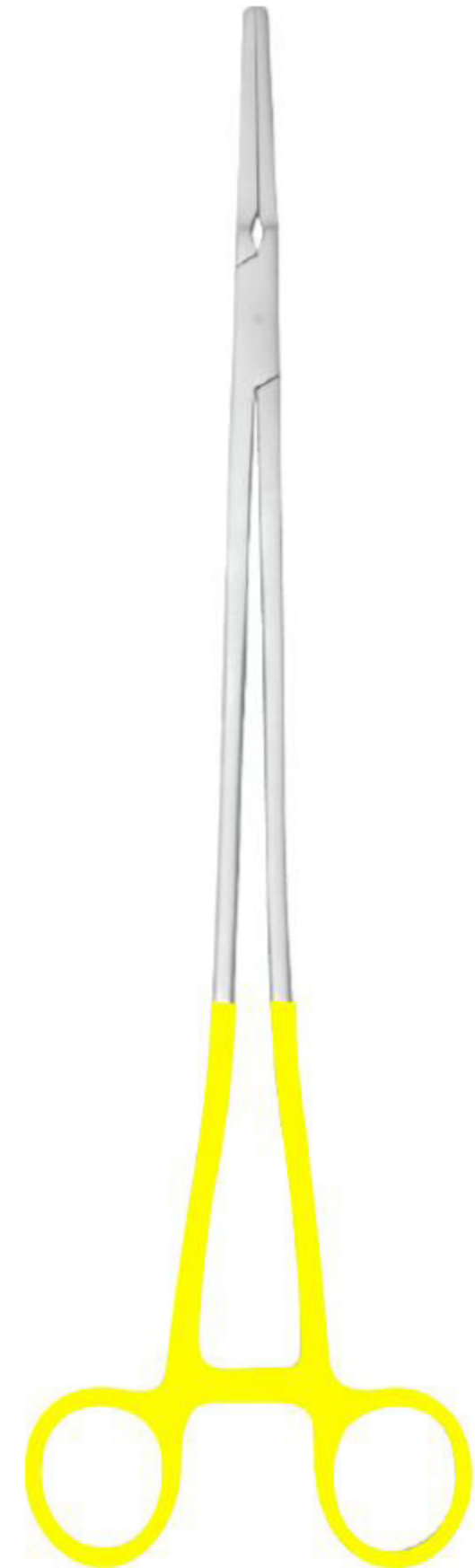

Zeppelin Clamps

Straight Handle with gold rings (without TC)

Straight	26-6411-21	26-6415-24	26-6419-30	26-6423-35
Slightly Curved	26-6412-21	26-6416-24	26-6420-30	26-6424-35
Strongly Curved	26-6413-21	26-6417-24	26-6421-30	26-6425-35
Angled	26-6414-21	26-6418-24	26-6422-30	26-6426-35
	21.5cm/8 1/2"	24cm/9 1/2"	30cm/12"	35cm/14"

- EN** Obstetrics
- DE** Geburtshilfe
- ES** Obstetricia

Page 559 to 565



For Internal Measurements



27-6501-45
 Laparotomy Ring
 1¾" Inside Diameter



De Lee
 27-6502-20
 20 cm/8"
 cm/Inch Scale



Martin
 27-6503-34 34 cm/13½" 27-6504-34
 cm Scale cm/Inch Scale



Collin
 27-6505-35
 35 cm/13¾"
 cm Scale



Breisky
 27-6506-33
 33 cm/13"
 cm Inch Scale



Collyer
 27-6507-30
 30 cm/12"
 cm Inch Scale



Iowa
 27-6508-14
 14 cm/5½"
 Trumpet Needle Guide



Wallich
 27-6511-42
 42 cm/16¾"



Winter
 28 cm/11"



Sanger
 21 cm/10½"

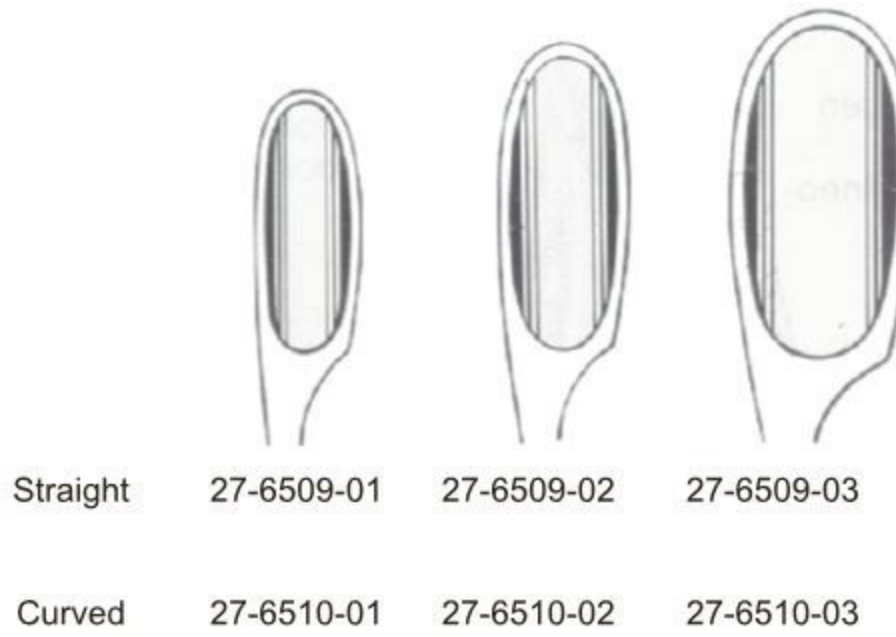

Straight	27-6509-01	27-6509-02	27-6509-03
Curved	27-6510-01	27-6510-02	27-6510-03

Straight
 27-6512-27

Curved
 27-6513-27

Uterine Haemostasis Forceps



Green-Armytage
 27-6514-21
 21 cm/8¼"

- EN —● Scalp flap forceps, perforators and elevating spoons
- DE —● Kopfschwartzangen, Geburtslöffel
- ES —● Pinza para pericráneo, separador para la salida de cabeza

Scalp Flap Forceps



Gauss
 27-6515-26
 26 cm/10¼"



Willet-Martel
 27-6516-19
 19 cm/7½"

Head Lever



Murless
 27-6517-26
 26 cm/10¼"

Elevating Spoon



Sellheim
 27-6518-28
 28 cm/11"



Smellie
 27-6519-25
 25 cm/10"

Perforators



Nagele
 27-6520-25
 25 cm/10"

Cranioclast, Hook and Cord Clamps ● EN
 Cranioclast, Hook und Cord Clamps ● DE
 Cranioclast, conectar el cable y abrazaderas ● ES

Cranioclast



Braun
 27-6521-42
 42 cm/16½"

Basiotribe



Tarnier
 27-6522-46
 46 cm/18"

Decapitating Hook



Braun
 27-6523-30
 30 cm/12"

Umbilical Cord Clamps



Collin
 27-6524-09
 9 cm/3½"



Nagele
 27-6525-36 36 cm/14"
 27-6525-40 40 cm/16"



Wrigley
 27-6526-28
 28 cm/11"



Simpson
 27-6527-23
 23 cm/9"



Simpson
 27-6528-28 28cm/11"
 27-6528-38 38cm/15"



Simpson-Braun
 27-6529-36
 36 cm/14"



Simpson-Luikart
 27-6530-36
 36 cm/14"

Obstetrical Forceps ● EN
 Geburtszangen ● DE
 Forceps obstétricos ● ES



De Lee
 27-6531-30 30 cm/12"
 27-6532-36 36 cm/14"

Traction Handles to be
 used with all obstetrical
 Forceps with Standard type Handles



Bill
 27-6533-20



Kielland
 27-6534-41
 41 cm/16"



Kielland-Luikart
 27-6535-40
 40 cm/15¾"



Mclean
 27-6536-36
 36 cm/14"



Elliot
 27-6537-32 32 cm/12½"
 27-6538-38 38 cm/15"



Piper
 27-6539-44
 44 cm/17¼"



With Traction Handle

Barnes-Neville
 27-6540-43
 43.5 cm/17"



With Traction Handle

Tarnier
 27-6541-40
 40 cm/15¾"

- EN** Sterilization
- DE** Sterilisation
- ES** Esterilización

Page 566 to 567





CHEATLE
 28-6601-27 27.0cm

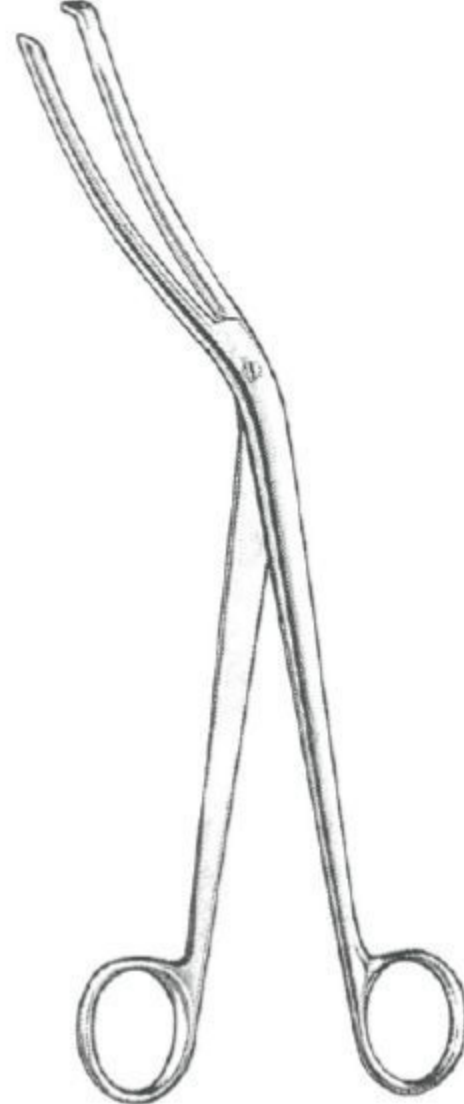

CHEATLE
 28-6602-27 26.5cm



CHEATLE
 28-6603-28 28.0cm



28-6604-20 20.0cm
 28-6604-30 30.0cm

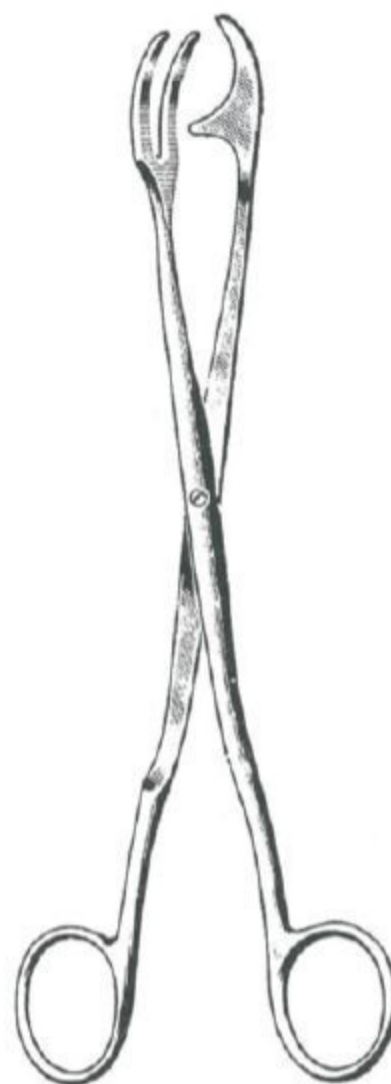

ROGGE
 28-6605-23 23.0cm



DAVIS
 28-6606-16 16.0cm
 28-6606-20 20.0cm
 28-6606-24 24.0cm



UNIVERSAL
 28-6607-20 20.0cm
 28-6607-28 28.0cm

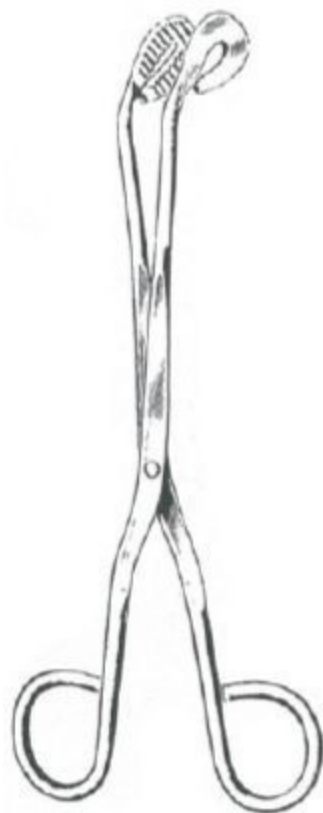

UNIVERSAL
 28-6608-20 20.0cm
 28-6608-28 28.0cm



PYE-SMITH (HARRISON)
 28-6609-25 25.0cm
 28-6609-30 30.0cm

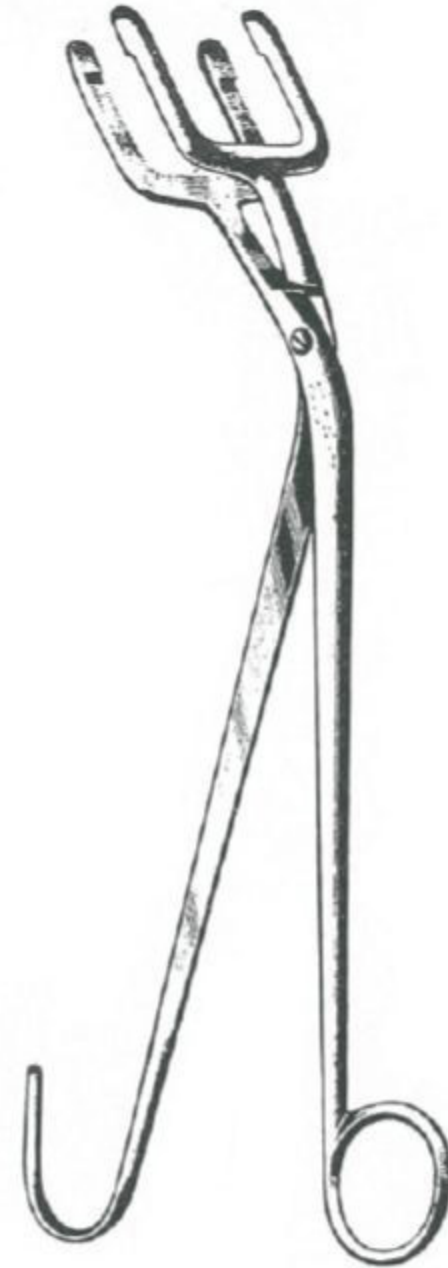

HARRISON
 28-6610-25 25.0cm
 28-6610-30 30.0cm
 28-6610-35 35.0cm
 28-6610-45 45.0cm

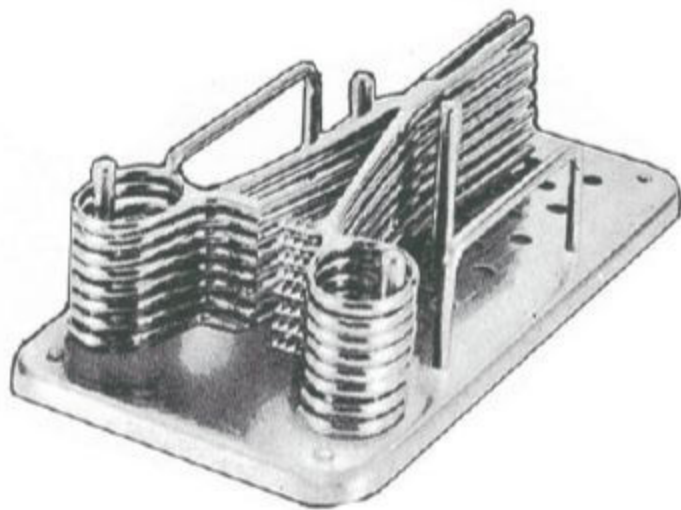

28-6611-00



BUNT
 28-6612-12 12.0cm



MAYO
 28-6613-10 10.0cm
 28-6613-12 12.0cm
 28-6613-14 14.0cm
 28-6613-15 15.0cm



MAYO
 28-6614-14 14.0cm

EN Asepsis

DE Asepsis

ES Asepsia

Page 568 to 559





cm	in	
11	4½"	29-6701-11
13	5	29-6701-13
14	5½"	29-6702-14
16	6¼"	29-6702-16



cm	in	
11	4½"	29-6704-11
13	5	29-6704-13
14	5½"	29-6703-14
15	6"	29-6703-15

Nail Scissor, Cuticle Scissor, Cuticle Nipper, Nail Nippers ● EN
 Nagelscheren, Hautscheren, Nagelhautzangen, Nagelzangen ● DE
 Tijeras para uñas, Pinjas y tijeras cuticulares, Pinzas corta-uñas ● ES

Stainless

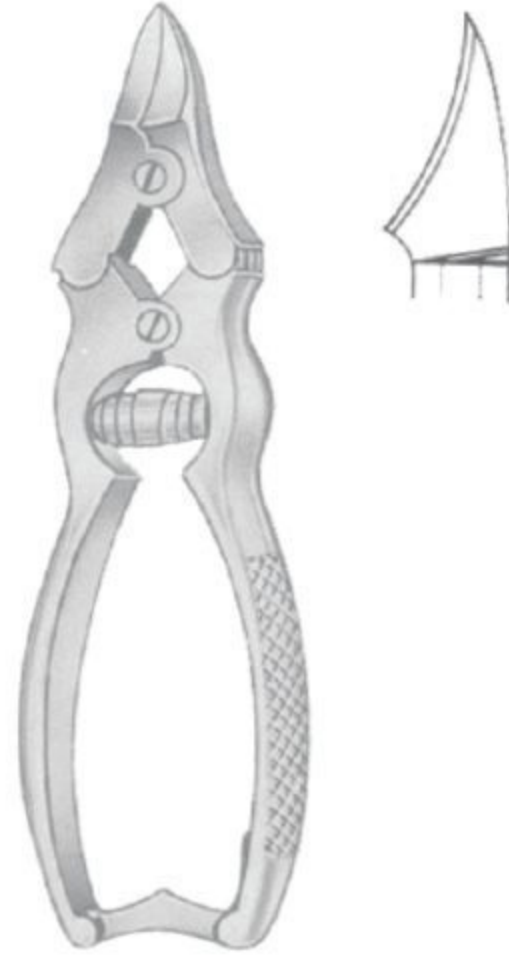

29-6705-15
 15 cm/6"



29-6706-10
 29-6706-10
 10 cm/4"



Straight
 Curved

29-6707-10
 29-6707-10
 10 cm/4"



29-6708-10
 10 cm/4"



29-6709-11
 11 cm/4½"
 29-6709-13
 13 cm/5"

EN Hollowware

DE Hollowware

ES Hollowware

Page 570 to 575



- EN —● Needle Case, Endodontic Box, Tube Rack, Cotton Holder, Sprit Lamp, Cup, Fennle and Jars
- DE —● Needle Case, Endodontie Box, Tube Rack, Cotton Holder, Sprit Lamp, Cup, Fennle und Jars
- ES —● Caso aguja, Caja de endodoncia, bastidor de tubo, titular de algodón, la lámpara Espiritu la Copa, Fennle y tarros



Needle Case Round with Cover
 30-6801-01 65x15mm



Needle Case Round
 30-6802-01 80x20mm



Needle Case Rectangle
 30-6803-01 70x70x10mm



Endodontic Box
 30-6804-01
 100x40x50mm

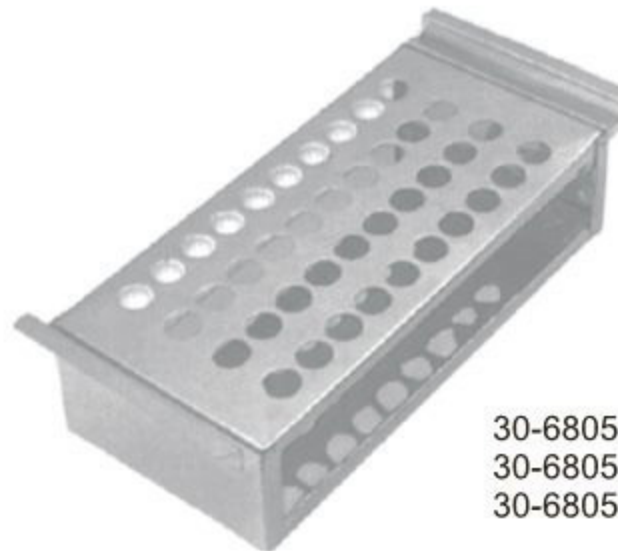

Tube Rack

- 30-6805-01 6.35x15.25x5cm for 12 tubes
- 30-6805-02 6.35x17.75x7.5cm for 27 tubes
- 30-6805-03 7.50x17.75x6.35cm for 36 tubes



Sprit Lamp
 30-6806-01
 Standard Size



Sprit Lamp
 30-6807-01
 Standard Size



Sputum Cup

- 30-6808-01 75x80mm
- 30-6808-02 100x50mm
- 30-6808-03 100x80mm



Dressing Jar

- | | | |
|------------|-----------|------------|
| 30-6809-01 | 80x60mm | 30-6810-01 |
| 30-6809-02 | 80x80mm | 30-6810-02 |
| 30-6809-03 | 100x100mm | 30-6810-03 |
| 30-6809-04 | 120x120mm | 30-6810-04 |
| 30-6809-05 | 150x150mm | 30-6810-05 |
| 30-6809-06 | 180x180mm | 30-6810-06 |
| 30-6809-07 | 200x200mm | 30-6810-07 |



Dressing Jar



Fennle

- 30-6812-01 100mm Ø
- 30-6812-02 120mm Ø
- 30-6812-03 150mm Ø
- 30-6812-04 200mm Ø



Cotton Holder
 30-6811-01



Cotton Holder
 30-6811A-01



Jars, Jallipot, Bowls, Cups, Kidney Trays ● EN
 Jars, Jallipot, Schalen, Becher, Kidney Trays ● DE
 Frascos, Jallipot, tazones, tazas, bandejas de riñón ● ES



Forceps Jar

- 30-6813-01 30x90mm
- 30-6813-02 50x125mm
- 30-6813-03 50x170mm
- 30-6813-04 50x200mm
- 30-6813-05 40x230mm
- 30-6813-06 70x110mm
- 30-6813-07 80x150mm
- 30-6813-08 100x200mm
- 30-6813-09 150x30mm



Medicine Cup

- 30-6816-01 50ml
- 30-6816-02 60ml
- 30-6816-03 70ml



Kick Bucket with Trolley

- 30-6819-01
- 390x280x180mm



Gallipot

- | | |
|------------------|------------------|
| 30-6814-01 01 oz | 30-6814-09 09 oz |
| 30-6814-02 02 oz | 30-6814-10 10 oz |
| 30-6814-03 03 oz | 30-6814-11 11 oz |
| 30-6814-04 04 oz | 30-6814-12 12 oz |
| 30-6814-05 05 oz | 30-6814-13 13 oz |
| 30-6814-06 06 oz | 30-6814-14 14 oz |
| 30-6814-07 07 oz | 30-6814-15 15 oz |
| 30-6814-08 08 oz | 30-6814-16 16 oz |



Spong Bowl

- 30-6815-01 12 cm
- 30-6815-02 15 cm
- 30-6815-03 20 cm



Lotion Bowl without spout

- | | |
|---------------------|----------------------|
| 30-6817-01 40x19mm | 30-6817-08 150x65mm |
| 30-6817-02 50x25mm | 30-6817-09 180x85mm |
| 30-6817-03 60x30mm | 30-6817-10 200x100mm |
| 30-6817-04 80x40mm | 30-6817-11 250x120mm |
| 30-6817-05 100x50mm | 30-6817-12 300mm |
| 30-6817-06 120x60mm | 30-6817-13 350mm |
| 30-6817-07 140x60mm | 30-6817-14 400mm |



Wash Basin

- 30-6818-01 300x80mm
- 30-6818-02 320x85mm
- 30-6818-03 330x90mm
- 30-6818-04 350x110mm
- 30-6818-05 400x115mm



Kidney Tray

- 30-6821-01 12cm
- 30-6821-02 15cm
- 30-6821-03 18cm
- 30-6821-04 20cm
- 30-6821-05 25cm
- 30-6821-06 28cm
- 30-6821-07 30cm



Kidney Tray Shallow

- 30-6820-01 17cm
- 30-6820-02 22cm
- 30-6820-03 24cm



Kidney Tray (with cover)

- 30-6822-01 15cm
- 30-6822-02 20cm
- 30-6822-03 25cm
- 30-6822-04 30cm

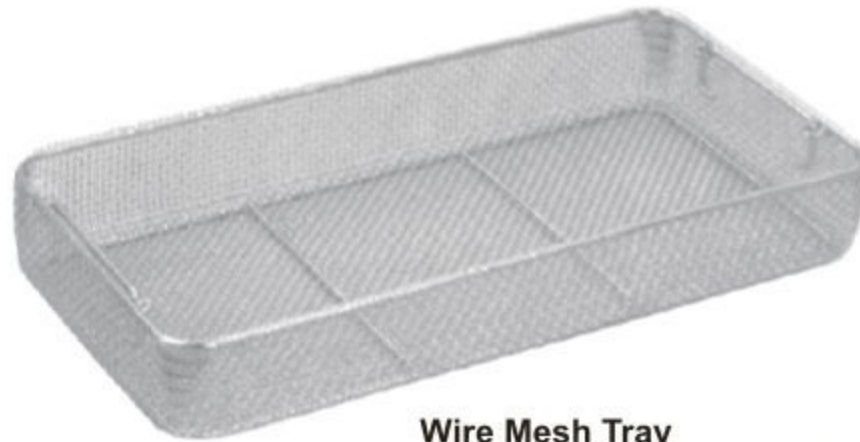

Wire Mesh Tray

- 30-6823-01 240x250x5mm
- 30-6823-02 480x250x5mm
- 30-6823-03 550x250x5mm
- 30-6823-04 240x250x7mm
- 30-6823-05 480x250x7mm
- 30-6823-06 240x250x10mm
- 30-6823-07 480x250x10mm

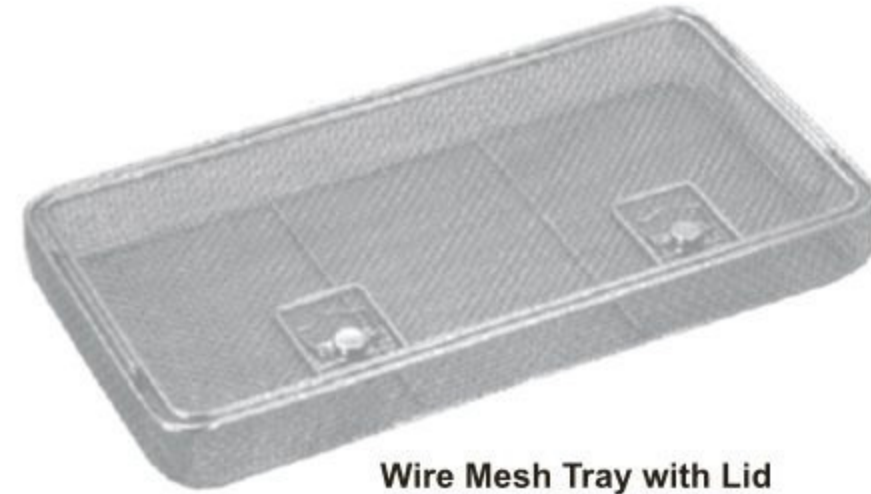

Wire Mesh Tray with Lid

- 30-6824-01 240x250x5mm
- 30-6824-02 480x250x5mm
- 30-6824-03 550x250x5mm
- 30-6824-04 240x250x7mm
- 30-6824-05 480x250x7mm
- 30-6824-06 240x250x10mm
- 30-6824-07 480x250x10mm



Perforated Tray

- 30-6825-01 200x100x40mm
- 30-6825-02 250x120x50mm
- 30-6825-03 300x150x50mm
- 30-6825-04 350x170x50mm
- 30-6825-05 400x200x50mm



Instruments Tray without Lid

- 30-6826-01 100x150x25mm
- 30-6826-02 150x200x40mm
- 30-6826-03 200x250x45mm
- 30-6826-04 250x300x50mm
- 30-6826-05 300x350x50mm
- 30-6826-06 150x300x50mm
- 30-6826-07 200x300x50mm
- 30-6826-08 230x150x50mm



Instruments Tray with Lid

- 30-6827-01 100x150x25mm
- 30-6827-02 150x200x40mm
- 30-6827-03 200x250x45mm
- 30-6827-04 250x300x50mm
- 30-6827-05 300x350x50mm
- 30-6827-06 150x300x50mm
- 30-6827-07 200x300x50mm
- 30-6827-08 230x150x50mm



Burr Tray
 30-6828-01
 190x100x20mm

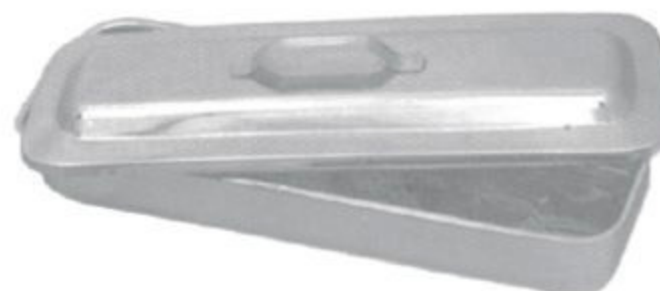

Cathetes Tray with Lid
 30-6829-01 300x80x40mm
 30-6829-02 350x90x45mm
 30-6829-03 400x100x50mm

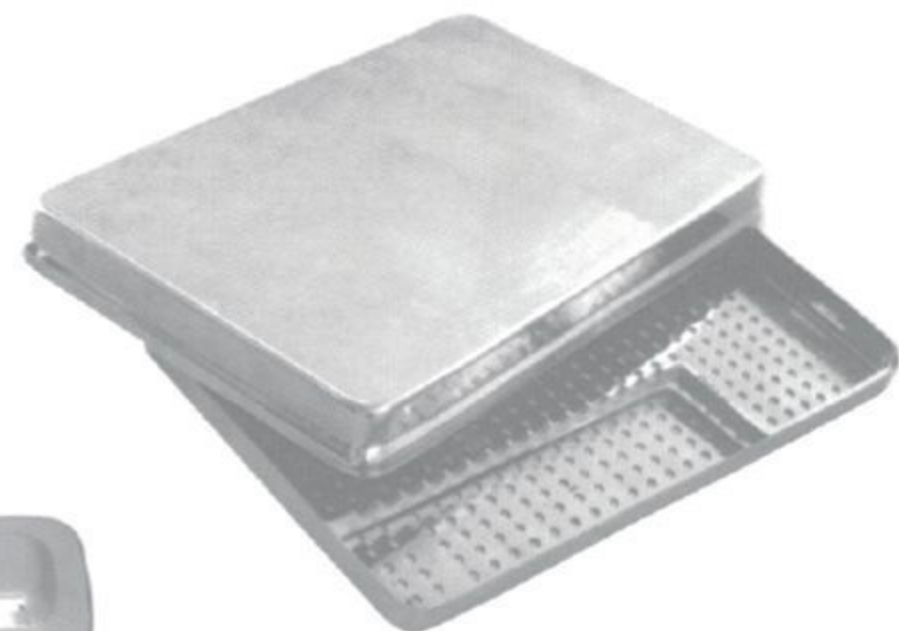

Scaler Tray with cover
 30-6830-01
 200x100x16mm



**Instruments Box
with Hooks**

30-6831-01	170x70x30mm
30-6831-02	180x80x40mm
30-6831-03	200x100x40mm
30-6831-04	230x120x50mm
30-6831-05	250x125x50mm
30-6831-06	300x150x50mm
30-6831-07	350x170x50mm
30-6831-08	400x200x90mm
30-6831-09	500x200x120mm



Instruments Box

30-6832-01	170x70x30mm
30-6832-02	180x80x40mm
30-6832-03	200x100x40mm
30-6832-04	230x120x50mm
30-6832-05	250x125x50mm
30-6832-06	300x150x50mm
30-6832-07	350x170x50mm
30-6832-08	400x200x90mm
30-6832-09	500x200x120mm



**Instruments Box
Perforated**

30-6833-01	200x100x40mm
30-6833-02	250x150x40mm
30-6833-03	300x150x40mm



Electric Sterilizer

30-6834-01	200x100x120mm
30-6834-02	250x120x140mm
30-6834-03	300x150x150mm
30-6834-04	350x170x170mm
30-6834-05	400x200x180mm
30-6834-06	450x230x190mm



Non Electric Sterilizer

30-6835-01	200x100x65mm
30-6835-02	250x125x65mm
30-6835-03	300x150x100mm
30-6835-04	350x170x65mm
30-6835-05	400x200x100mm



Electric Sterilizer
 30-6836-01
 280x125x65mm

30-6837-01	125x80mm
30-6837-02	125x120mm
30-6837-03	150x100mm
30-6837-04	150x150mm
30-6837-05	180x180mm
30-6837-06	190x140mm
30-6837-07	190x190mm
30-6837-08	200x200mm
30-6837-09	240x120mm
30-6837-10	240x240mm
30-6837-11	290x140mm
30-6837-12	290x240mm
30-6837-13	290x290mm
30-6837-14	340x160mm
30-6837-15	340x340mm
30-6837-16	390x150mm
30-6837-17	390x200mm
30-6837-18	390x290mm



Sterilizer Drum



Bedpan Hand Made
 30-6838-01
 Standard



Bedpan Hand Made
 30-6839-01 Adult
 30-6839-02 Child



Bedpan Hand Made
 30-6840-01
 Standard



Bedpan Simple
 pressed body with handle
 30-6842-01 Adult
 30-6842-02 Child



Bedpan Sleeper Type
 30-6843-01 Adult
 30-6843-02 Child



Bedpan Chamber Port
 30-6844-01
 Standard

Bedpan, Jug, Bucket, Irrigator and Dustbin ● EN
 Steckbecken, Krug, Eimer, Irrigator und Mülleimer ● DE
 Chata, jarro, cuchara, Irrigación y cubo de basura ● ES

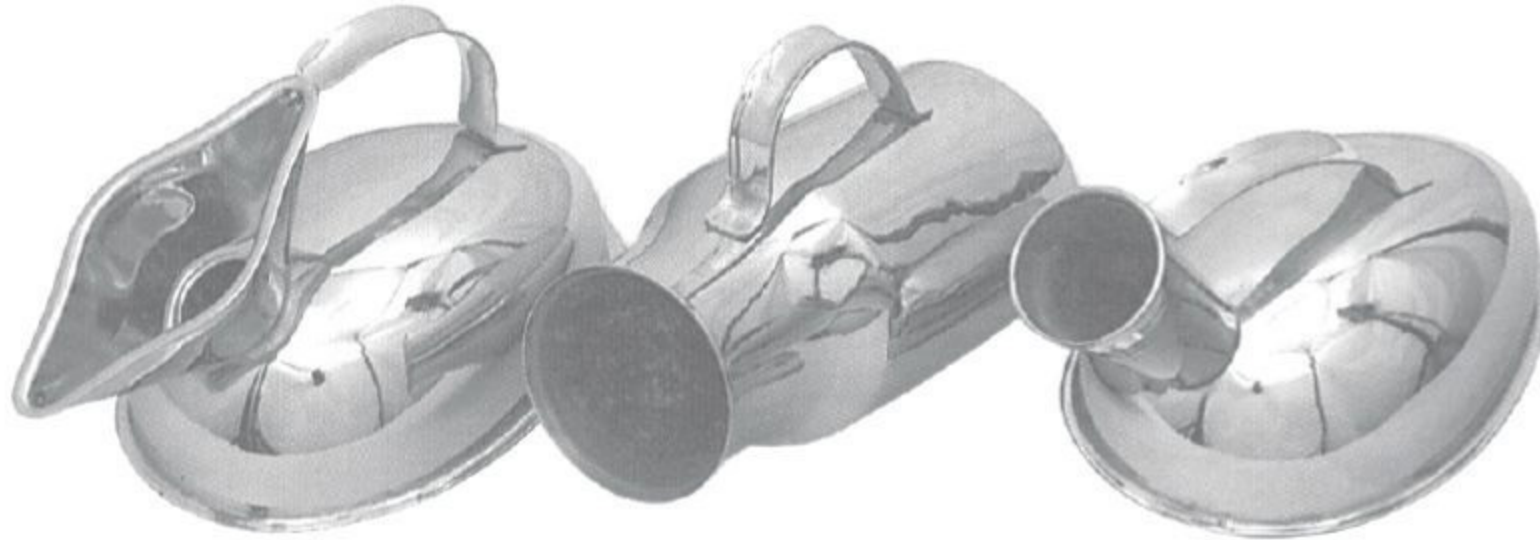

Urinal Female
 30-6845-01
 Standard

Urinal Male Vertical
 30-6846-01
 Standard

Urinal Male
 30-6847-01
 Standard



**Bedpan perfection
 type seamless**
 30-6848-01
 350x300mm



Bedpan perfection type
 30-6849-01 370x290mm
 30-6849-02 320x240mm



Dustbin
 30-6851-01 210mm
 30-6851-02 240mm
 30-6851-03 270mm
 30-6851-04 300mm



Pail/Bucket with Lid
 30-6850-01 06 Ltr
 30-6850-02 10 Ltr
 30-6850-03 15 Ltr



Measuring Jug
 30-6852-01 0.5 Ltr
 30-6852-02 1.0 Ltr
 30-6852-03 1.5 Ltr
 30-6852-04 2.0 Ltr



Douch Can/Irrigator
 30-6853-01 1.0 Ltr
 30-6853-02 1.5 Ltr
 30-6853-03 2.0 Ltr



Office Address

Street No. 34 Hassan Pura Miana Pura

Sialkot - 51310, Pakistan.

Tel: +92 303 7039566

Email: info@ruksonsurgical.com