

- EN** Ophthalmology
- DE** Ophthalmologie
- ES** Oftalmología

**Page 389 to 419**





**Weiss**  
 Children 16-4501-07  
 7 cm/2¾"



**Weiss**  
 Children 16-4503-07  
 7 cm/2¾"  
 Adults 16-4504-09  
 9 cm/3½"



**Park**  
 16-4505-08  
 8 cm/3¼"



**Park-Guyton**  
 16-4506-08  
 8 cm/3¼"



**Park-Maumenee**  
 16-4507-08  
 8 cm/3¼"



**Barraquer (Colibri)**  
 Children 16-4508-03  
 3 cm/1¼"  
 Adults 16-4509-04  
 4 cm/1½"



**Barraquer**  
 16-4510-04  
 4 cm/1½"



**Bowman**  
 16-4511-07  
 7 cm/2¾"



**Sauer**  
 16-4512-03  
 3 cm/1¼"



**Goldstein**  
 16-4513-03  
 3 cm/1¼"



**Pley**  
 16-4514-06  
 6 cm/2¼"

For left eye

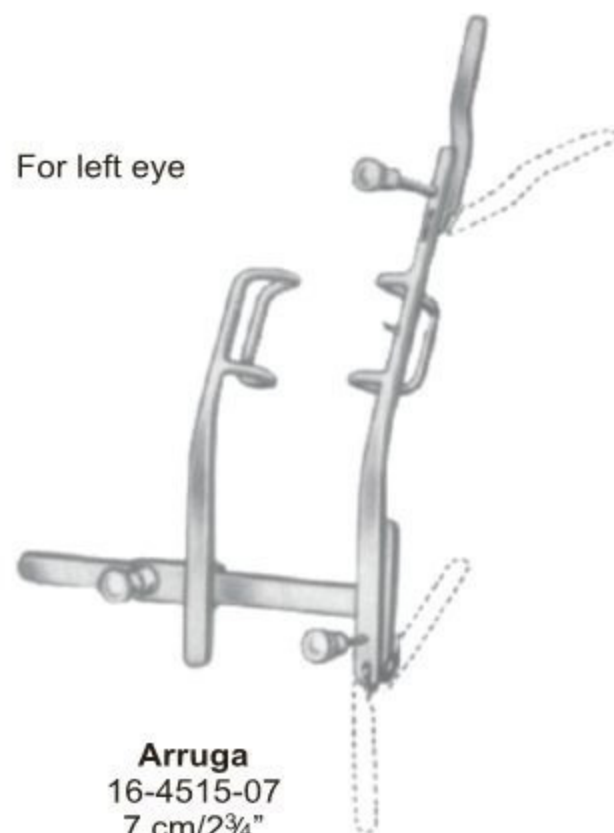

**Arruga**  
 16-4515-07  
 7 cm/2¾"

For right eye



**Arruga**  
 16-4516-07  
 7 cm/2¾"

Eye Speculas ● EN  
 Lidsperren ● DE  
 Espéculos ojo ● ES



**Mellinger-Axenfeld**  
 16-4517-07  
 7 cm/2 3/4"



**Mellinger-Axenfeld**  
 16-4518-07  
 7 cm/2 3/4"

Children  
 16-4519-05  
 5 cm/2 3/4"



**Mellinger**  
 Adults  
 16-4520-07  
 7 cm/2 3/4"



Children  
 16-4521-05  
 5 cm/2"

**Mellinger Beard**  
 Adults  
 16-4522-07  
 7 cm/2 3/4"



**Knapp Clark**  
 16-4523-08  
 8 cm/3 1/4"



Children  
 16-4524-06  
 6 cm/2 1/2"

**Graefe**  
 Adults  
 16-4525-09  
 9 cm/3 1/2"



**Lancaster**  
 16-4526-08  
 8 cm/3 1/4"



Children  
 16-4527-07  
 7 cm/2 3/4"

**Williams**  
 Adults  
 16-4528-08  
 8 cm/3 1/4"



**Lister-Burch**  
 16-4529-08  
 8 cm/3 1/4"



**Weiss**  
 16-4530-08  
 8 cm/3 1/4"



**Murdock**  
 16-4531-05  
 5 cm/2"



**Mueller**  
 16-4532-07  
 7 cm/2 3/4"



**Critchett**  
 16-4533-06  
 6 cm/2 1/2"



**Castroviejo**  
 16-4534-08  
 8 cm/3 1/4"



**Schepens**  
 16-4535-13  
 13 cm/5"



**Desmarres**  
 16-4536-13  
 13 cm/5"



8 mm

**Conway**  
 16-4537-13  
 13 cm/5"



**Desmarres**  
 13 cm/5"



16-4538-12  
 12 mm



16-4538-14  
 14 mm



16-4538-16  
 16 mm



16-4538-18  
 18 mm

Lid plate



**Jaeger**  
 16-4539-11  
 11 cm/4½"

Eye Knives ●— EN  
 Eye Messer ●— DE  
 Cuchillos ojo ●— ES

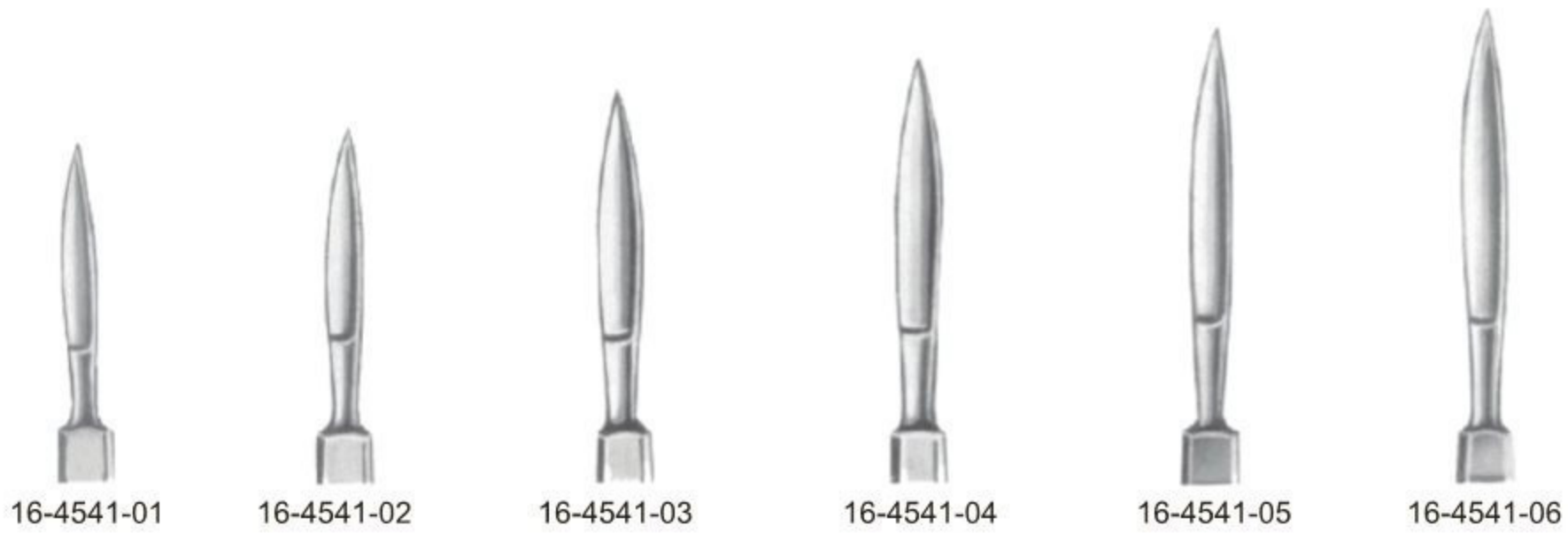

Graefe



Graefe-Arruga

Deutschmann

Wheeler



**Jaeger**  
 16-4544-01



16-4544-02



16-4544-03



16-4544-04



16-4545-01



16-4545-02



16-4545-03



16-4545-04



16-4546-01



16-4546-02



16-4546-03



16-4546-04



16-4547-01



16-4547-02



16-4547-03



16-4547-04

**Jaeger-Grieshaber**



16-4548-01



16-4548-02



16-4548-03



16-4548-04

**Jaeger-Grieshaber**

Keratomes, Various Eye Knives ●— EN  
 Keratomes, Verschiedene Eye Messer ●— DE  
 Keratomes, varios cuchillos de ojos ●— ES

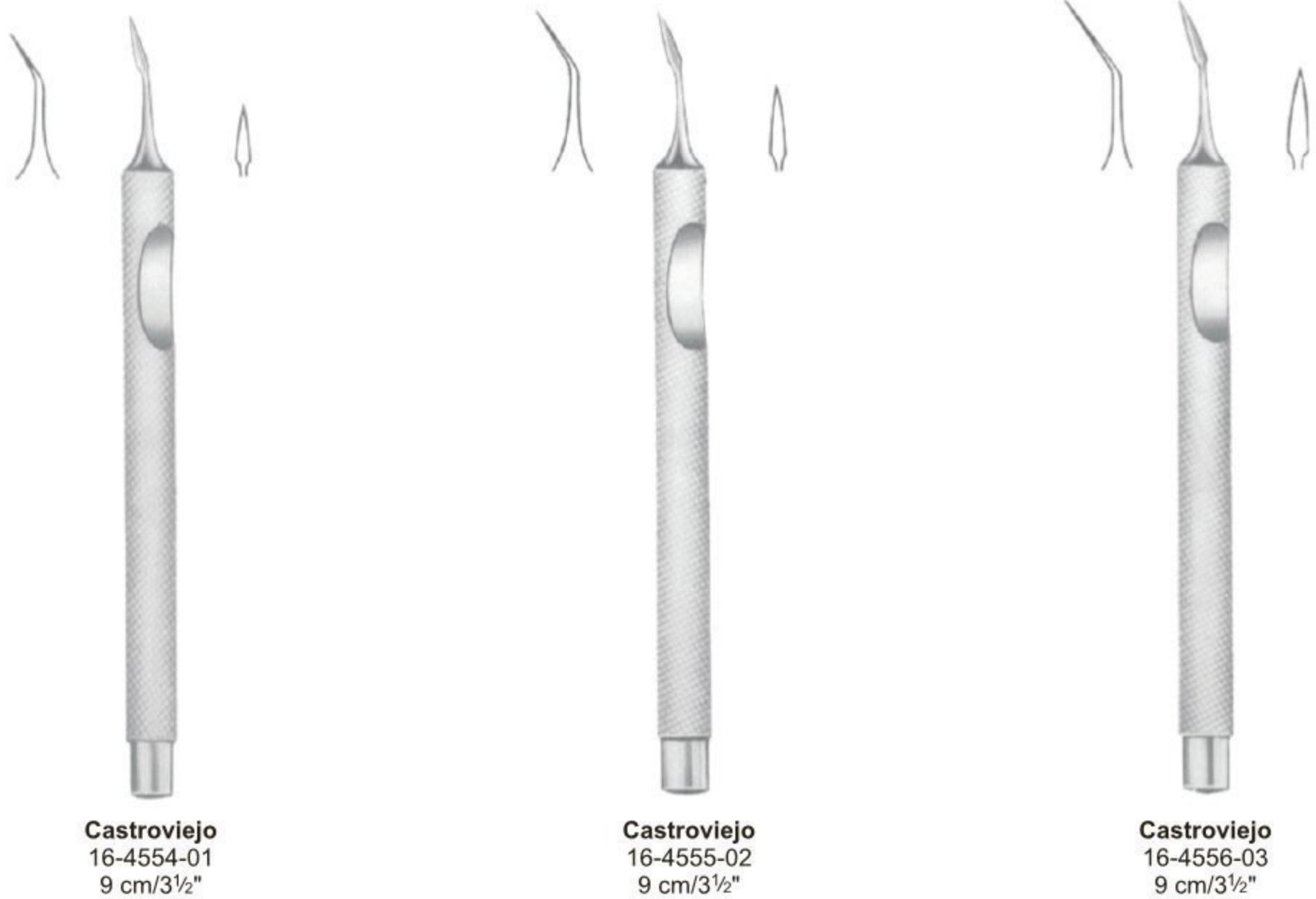



**Mod. Hamburg**  
 16-4557-12



**Graefe**  
 16-4558-13



16-4559-01



**Weber**  
 16-4559-02



16-4559-03



**Bowman**  
 16-4560-04  
 0.4 mm



**Bowman**  
 16-4560-05  
 0.5 mm



**Bowman**  
 16-4560-06  
 0.6 mm



**Bowman**  
 16-4560-07  
 0.7 mm



**Bowman**  
 16-4560-08  
 0.8 mm



Left **Bowman** Right  
 16-4561-01 16-4561-02



16-4562-01



**Knapp**  
 16-4562-02



16-4562-03



16-4563-05  
 5 mm



**Ziegler**  
 16-4563-06  
 6 mm



16-4563-07  
 7 mm



Various Eye Knives ● EN  
 Verschiedene Eye Messer ● DE  
 Varios cuchillos de ojos ● ES



**Dean**  
16-4564-13



**Zigler**  
16-4565-11  
3½ mm



**Sato**  
16-4566-12



**Sichel**  
16-4567-13



**Graefe**  
16-4568-13



**Graefe**  
16-4569-13



16-4570-01



**Kuhnt**  
16-4571-02



16-4572-03



16-4573-04



**Paton**  
16-4574-12



**Elsching**  
16-4575-13



**Took**  
16-4576-12



16-4577-01



**Desmarres**  
16-4578-02



16-4579-03



**Gill**  
16-4580-12

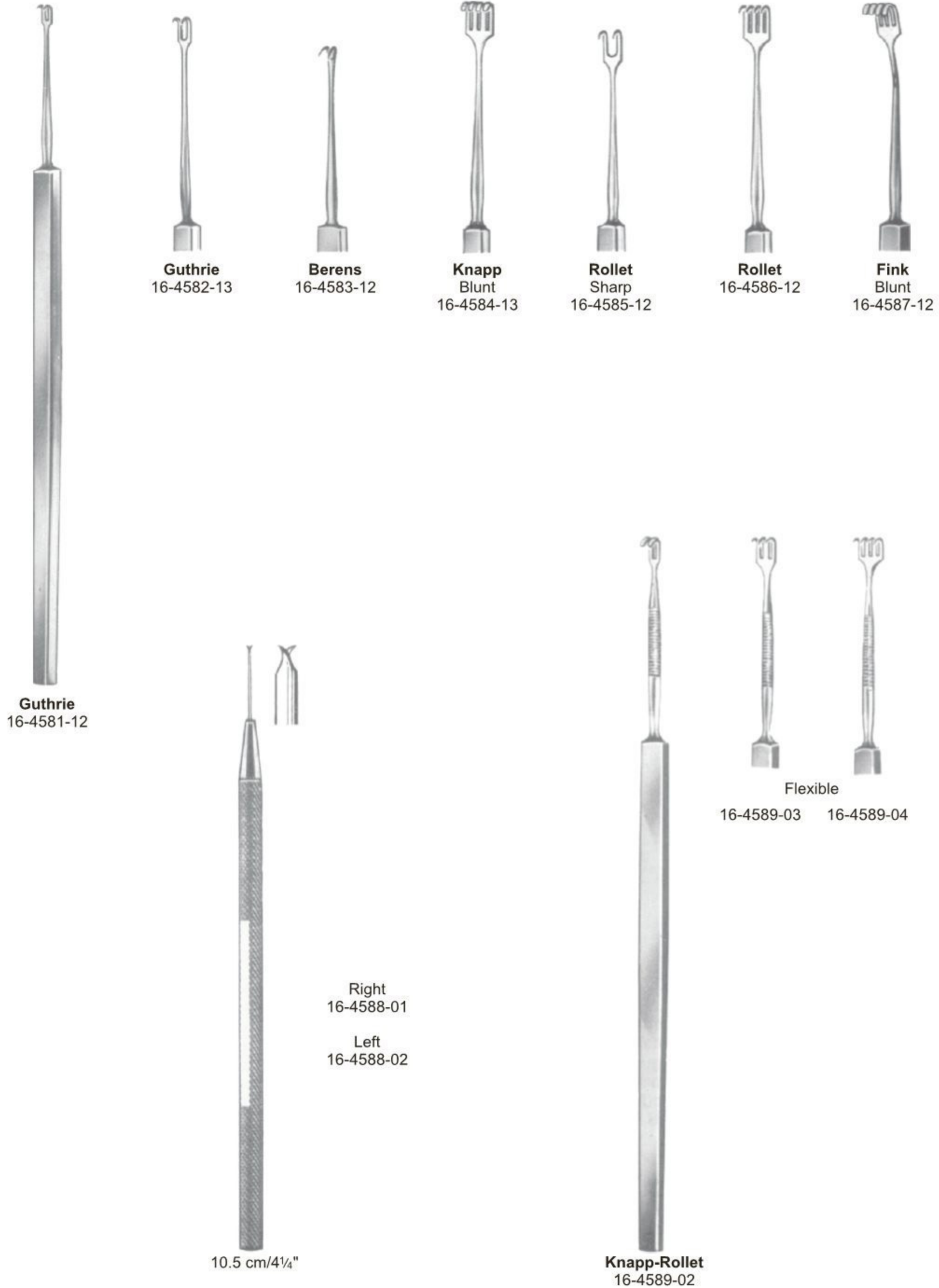



**Axenfeld**

Sharp  
16-4590-14

Blunt  
16-4591-14



**Axenfeld**

Sharp  
16-4592-14

Blunt  
16-4593-14



**Paul**  
16-4594-12



**Sautter**  
16-4595-01



**Sautter**  
16-4596-02



**Sautter**  
16-4597-03



**Arruga**  
16-4598-13



**Stevens**  
16-4599-14



**Stevens**  
16-4600-12



**Graefe**  
16-4601-01



**Graefe**  
16-4602-02



**Graefe**  
16-4603-03



**Wecker**  
16-4604-13



**Wecker**  
16-4605-13



**Stock**  
16-4606-13



**Stock**  
16-4607-13



**Culler**  
16-4608-13



**Suker**  
16-4609-14

- EN —● Enucleation Scoops and Chalazion Curettes
- DE —● Enucleation Schaufeln und Chalazion Küretten
- ES —● Enucleación Scoops y curetas Chalazión

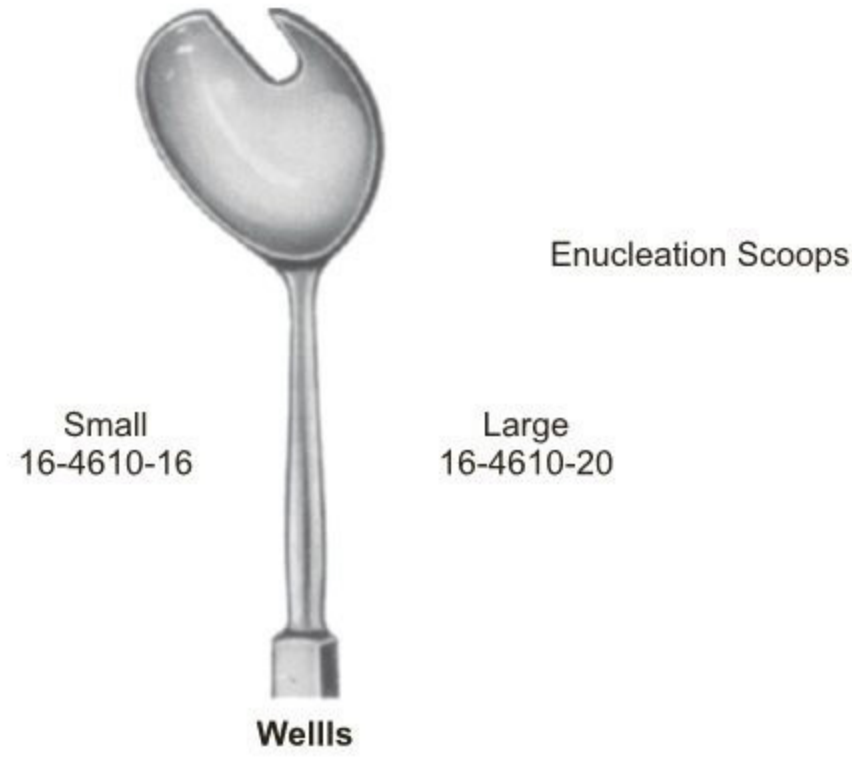

Chalazion Curettes



Exenteration Scoops and Chalazion Curettes Lachrymal Sac Dissectors ● EN

Exenteration Schaufeln und Chalazion Küretten Tränensack Dissektoren ● DE

Exenteración Scoops y Chalazión Curetas saco lagrimal Disectores ● ES

Exenteration Scoops



16-4613-01      16-4613-02      **Bunge** 16-4613-03      16-4613-04      16-4613-05



Chalazion Curette, Double

**Axenfeld**  
16-4614-13  
13 cm/5"



Lachrymal Sac Dissector

**Lang**  
16-4615-13  
13 cm/5"

Irrigating Cannulas

Straight



**Binkhorst**  
 16-4616-01  
 22 gauge

Right



**Binkhorst**  
 16-4617-02  
 22 gauge

Left



**Binkhorst**  
 16-4618-03  
 22 gauge



**Bonn**  
 16-4619-04  
 20 gauge



**Bonn**  
 16-4620-05  
 19 gauge

Probe Point



**Hamburg**  
 16-4621-06  
 23 gauge

Irrigation/Aspiration Cannulas



**Simcoe**  
 16-4622-01  
 23 gauge



stotome Cannulas

**Gills-Welsh**  
 16-4623-02  
 25/23 gauge

Lens Manipulation Cannulas



**Knolle-Kelmann**  
 16-4624-01  
 22 gauge



**Nevyas**  
 16-4625-02  
 22 gauge



**Kratz**  
 16-4626-03  
 22 gauge



**Freeman**  
 16-4627-01  
 27 gauge

Eye Cannulas ●— EN  
 Augenkanülen ●— DE  
 Cánulas ojo ●— ES



**Sheets**  
 16-4628-01

Irrigating Vectis Cannulas



**Knolle Pearce**  
 16-4629-02



**Simcoe**  
 16-4630-03

Cortex Aspiration Cannulas



**Simcoe**  
 16-4631-01  
 23 gauge



**Simcoe**  
 16-4632-02  
 23 gauge

Capsule Polishing Cannulas



**Kratz**  
 16-4633-01



**Simcoe**  
 16-4634-02

Posterior



**Jensen**  
 16-4635-03

- EN —● Calipers, Markers, Punches Chisels, Marking instruments and Lachrymal Dilators
- DE —● Messschieber, Marker, Punches Meißel, Kennzeichnung Instrumente und Lachrymal Dilatoren
- ES —● Pinzas, marcadores, cinceles Punzones, los instrumentos de marcado y Dilatadores lagrimales



**Castroviejo**  
16-4636-15



**Castroviejo**  
16-4637-20  
20 mm



**Holth**  
16-4638-01



**Haitz**  
16-4639-02



**West**  
16-4640-16  
16 cm/6 1/4"



**West**  
16-4641-16  
16 cm/6 1/4"



**Connin-Amsler**  
16-4642-13  
13 cm/5"



**Wilder**  
16-4643-01



**Wilder**  
16-4644-02



**Wilder**  
16-4645-03



Lachrymal Dilators and Probes ● EN  
 Lachrymal Dilatoren und Probes ● DE  
 Dilatadores lagrimales y sondas ● ES



16-4646-13 16-4647-13

Needle Only  
 16-4648-01

Chisel Only  
 16-4648-02

Gouge Only  
 16-4648-03



16-4649-13

Instrumentation for D. B. Kirby Operations



16-4650-10



Teeth  
 16-4651-10 1:2 Teeth  
 16-4652-10 2:3 Teeth



16-4653-10  
 1 : 2



**Kirby**  
 16-4654-10  
 10 cm/4"



**Kirby**  
 16-4655-10  
 10 cm/4"



16-4656-10



16-4657-10



**Tuebingen**  
 16-4658-10  
 10 cm/4"



16-4659-08  
 8.5 cm/3 1/2"



**Paufigue**  
 16-4660-10  
 10 cm/4"



**Barraquer**  
 16-4661-10  
 10.5 cm/4 1/4"



**McPherson**  
 16-4662-10  
 10 cm/4"



**McPherson**  
 16-4663-07  
 7.5 cm/3"

Suture Forceps, Strabismus Forceps ●— EN  
 Suture Pinzetten, Zangen Strabismus ●— DE  
 Sutura Pinzas, estrabismo ●— ES



**McCullough**  
 16-4664-09  
 9.5 cm/3 3/4"



**McCullough**  
 16-4665-09  
 9.5 cm/3 3/4"



**Bonaccoito**  
 16-4666-10  
 10 cm/4"



**Bonaccoito**  
 16-4667-10  
 10 cm/4"



16-4668-11  
 11 cm/4 1/2"



11 cm/4 1/2"

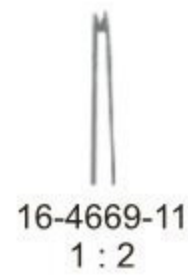

16-4669-11  
 1 : 2

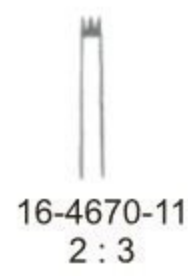

16-4670-11  
 2 : 3



**Nugent**  
 10 cm/4"



16-4671-01



16-4672-02

EN —● Strabismus, Muscle and Advancement Forceps

DE —● Strabismus, Muskel-und Advancement Zange

ES —● Estrabismo, los músculos y Promoción Pinzas

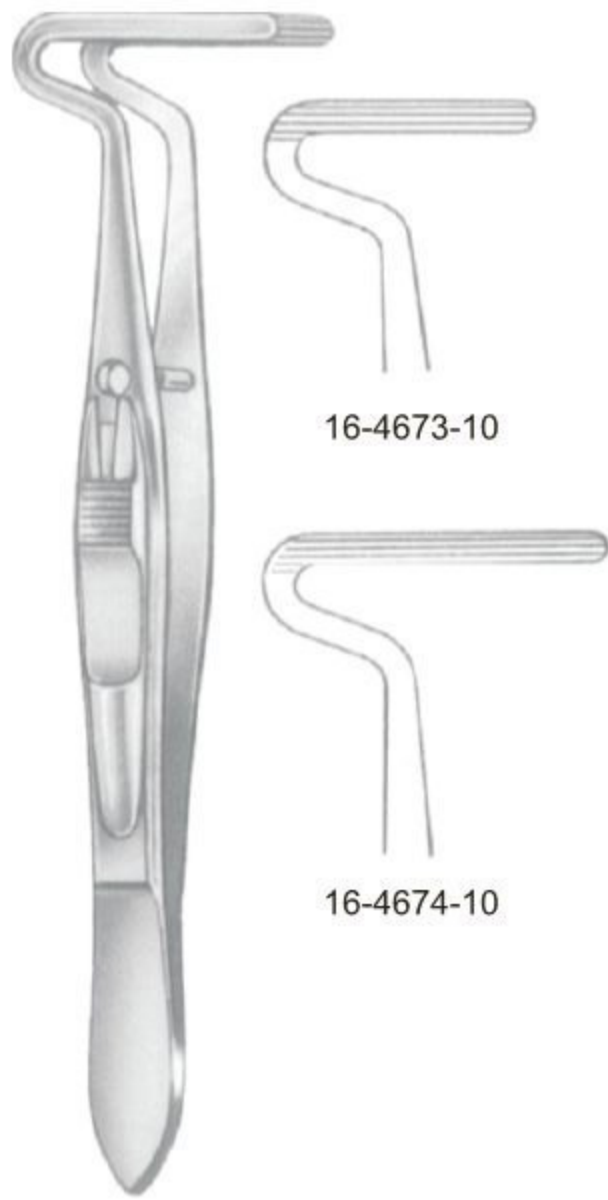

**Berke**  
 10 cm/4"



**Blascovics**  
 16-4675-09  
 9 cm/3 1/2"



**Blascovics**  
 16-4676-09  
 9 cm/3 1/2"



**Worth**  
 16-4677-10  
 10 cm/4"



**Worth**  
 16-4678-10  
 10 cm/4"



**Jameson**  
 16-4679-10  
 10 cm/4"



**Jameson**  
 16-4680-10  
 10 cm/4"



**Prince**  
 16-4681-10  
 10 cm/4"



**Prince**  
 16-4682-10  
 10 cm/4"

Entropium, Anterior Chamber Forceps ● EN  
 Entropium, Vorderkammer Zange ● DE  
 Entropion, pinzas Cámara Anterior ● ES



**Snellen**  
 16-4683-10  
 10 cm/4"



**Snellen**  
 16-4684-10  
 10 cm/4"



**Erhardt**  
 16-4685-09  
 9 cm/3 1/2"

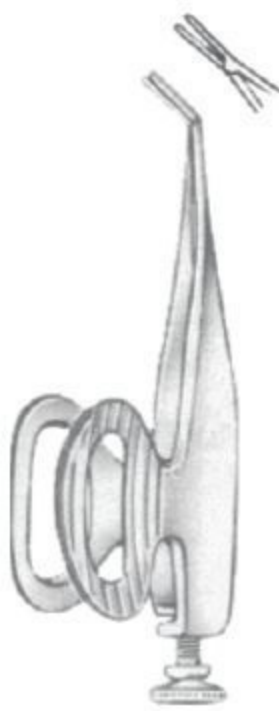

**Barraquer**  
 16-4686-05  
 5.5 cm/2 1/4"



**Barraquer**  
 16-4687-07  
 5.5 cm/2 1/4"



**Barraquer**  
 16-4688-10  
 5.5 cm/2 1/4"



Iris Forceps ● EN

Iris Zange ● DE

Iris Pinzas ● ES



**Graefe**  
10 cm/4"



16-4696-10



16-4697-10



16-4698-10



16-4699-10



16-4700-10



16-4701-10

Conjunctival forceps



**Stevens**  
10.5 cm/4¼"



16-4702-10



16-4703-10



16-4704-10



**O'Connor**  
16-4708-10  
10 cm/4"



16-4705-10



16-4706-10



16-4707-10



**Stevens**  
16-4709-11  
11 cm/4½"



**Stevens**  
16-4710-11  
11 cm/4½"



**Fischer**  
 16-4711-07  
 7 cm/2 3/4"



**Fischer-Arit**  
 16-4712-07  
 7 cm/2 3/4"



**Hess**  
 16-4713-07  
 7 cm/2 3/4"



**Hess**  
 16-4714-07  
 7 cm/2 3/4"



Smooth **Chandler** Serrated  
 16-4715-01 7 cm/2 3/4" 16-4716-02



**Fuchs**  
 16-4717-07  
 7 cm/2 3/4"



**Gill-Hess**  
 16-4718-07  
 7.5 cm/3"



**Gill-Hess** Teeth Below  
 16-4719-07 7.5 cm/3"  
 Teeth on side 16-4720-07



**Barraquer-Katzin**  
 (Colibri)  
 16-4721-07  
 7 cm/2 3/4"



Capsular Forceps ● EN  
 Kapsel-Pinzetten ● DE  
 capsular Pinzas ● ES



**Fuchs**  
 16-4722-07  
 7 cm/2 3/4"



**Kalt**  
 16-4723-10  
 10 cm/4"



**Terson**  
 16-4724-09  
 9.5 cm/3 3/4"



**Arruga-Nizetic**  
 16-4725-10  
 10 cm/4"



**Castroviejo**  
 16-4726-10  
 10 cm/4"



**Castroviejo**  
 16-4727-10  
 10 cm/4"



**Elschnig**  
 16-4728-10  
 10 cm/4"

For Len Implantation



**Binkhorst**  
 16-4729-07  
 7 cm/2 3/4"



**Arruga**  
 16-4730-09  
 9.5 cm/3 3/4"



**Arruga**  
 16-4731-09  
 9.5 cm/3 3/4"



**Knapp**  
 16-4732-11  
 11 cm/4¼"



**Ayer**  
 16-4733-09  
 9 cm/3½"



**Ayer**  
 16-4734-09  
 9 cm/3½"



**Lambert**  
 16-4735-09  
 9 cm/3½"



**Desmarres**  
 16-4736-01  
 9 cm/3½"



16-4736-01



16-4737-02



16-4738-03

Iridectomy Scissors ●— EN  
 Iridektomie Scissors ●— DE  
 Tijeras iridectomía ●— ES



Fig. 1



Fig. 2

Fig. 3

**Noyes**  
 Fig.1 16-4739-01  
 Fig.2 16-4739-02  
 Fig.3 16-4739-03  
 12 cm/4 ¾"



**Noyes**  
 16-4740-12  
 12 cm/4 ¾"



**Wecker**  
 11.5 cm/4 ½"



16-4741-01



16-4742-02



**Barraquer**  
 16-4743-05  
 5.5 cm/2 ¼"



16-4744-09  
 9 cm/3 ½"



16-4745-09



16-4746-09



16-4747-09



16-4748-09



16-4749-09



Straight

**Vannas**  
 16-4750-08  
 8 cm/3 1/4"



Curved

**Vannas**  
 16-4751-08  
 8 cm/3 1/4"

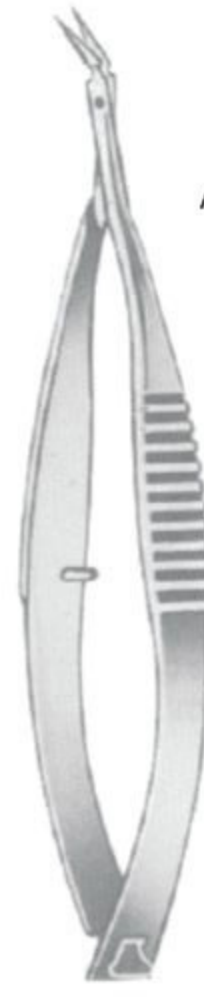

Angular

**Vannas**  
 16-4752-08  
 8 cm/3 1/4"

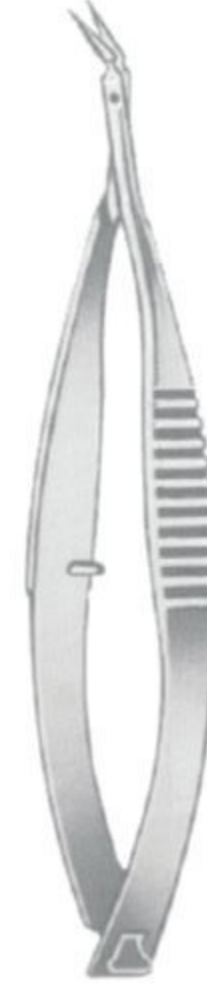

**Vannas**  
 16-4753-08  
 8 cm/3 1/4"



Straight

16-4754-08  
 8.5 cm/3 1/4"



Curved

16-4755-08  
 8.5 cm/3 1/4"



Angular

16-4756-08  
 8.5 cm/3 1/4"



Angular

16-4757-08  
 8.5 cm/3 1/4"

Iridectomy Scissors ●— EN  
 Iridektomie Scissors ●— DE  
 Tijeras iridectomía ●— ES



16-4758-10  
 10 cm/4"



16-4759-10  
 10 cm/4"



**Castroviejo**  
 16-4760-10  
 10 cm/4"



**Castroviejo**  
 16-4761-10  
 10 cm/4"



**Aebli**  
 16-4762-10  
 10 cm/4"

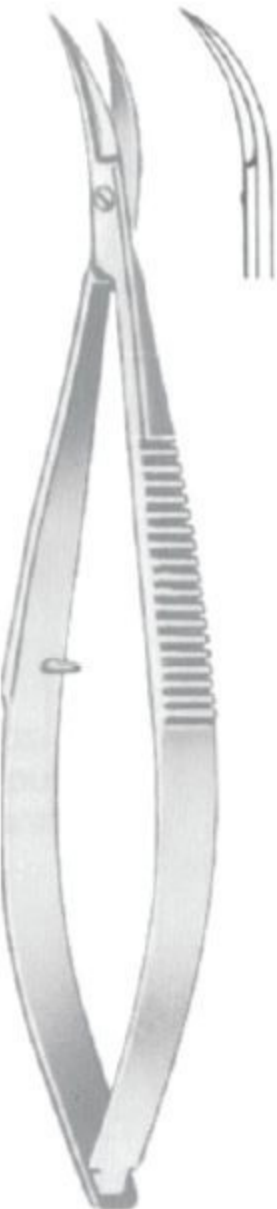

**Castroviejo**  
 16-4763-10  
 10 cm/4"

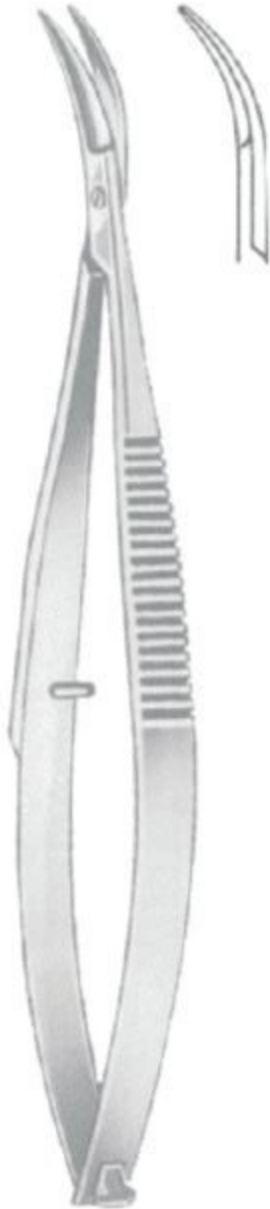

**Castroviejo**  
 16-4764-10  
 10 cm/4"

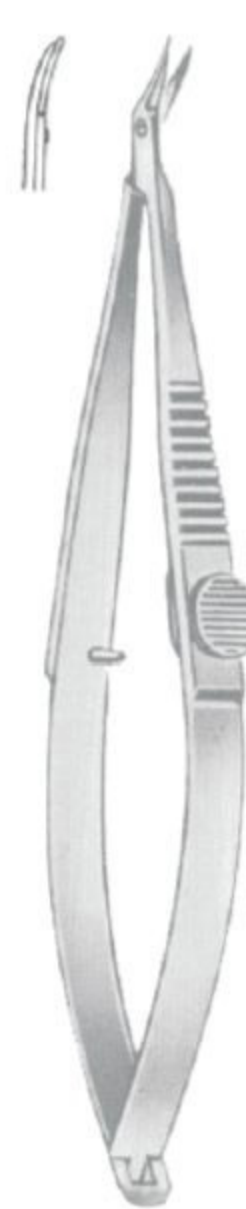

**Troutman-Barraquer**  
 16-4765-10  
 10 cm/4"

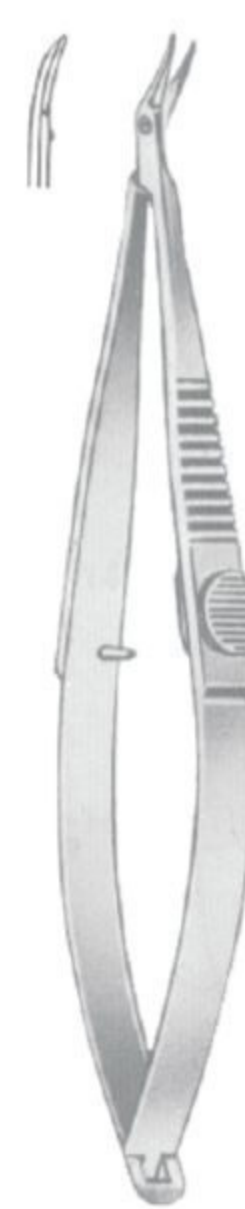

**Troutman-Barraquer**  
 16-4766-10  
 10 cm/4"



Saw Edge

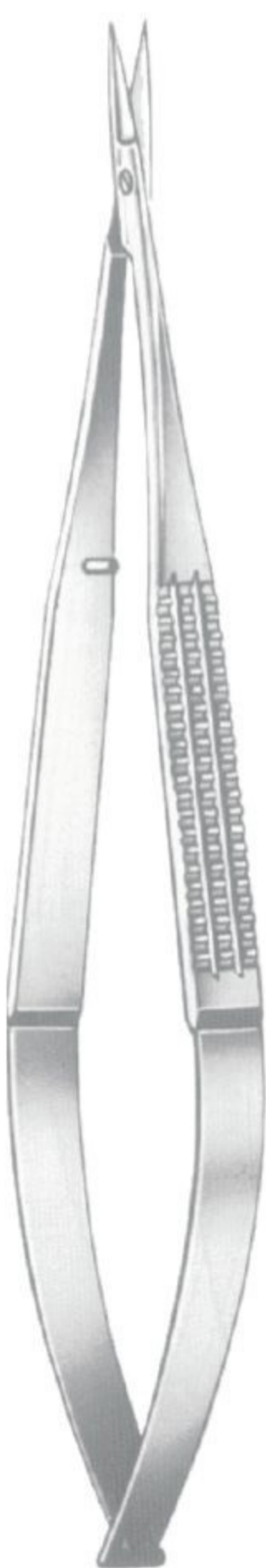

Straight  
 16-4767-16  
 16cm/6 1/4"

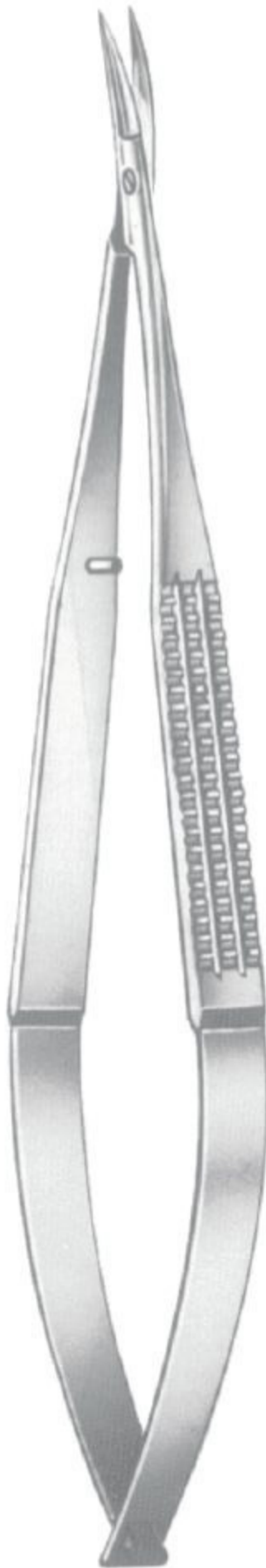

Curved  
 16-4768-16  
 16cm/6 1/4"

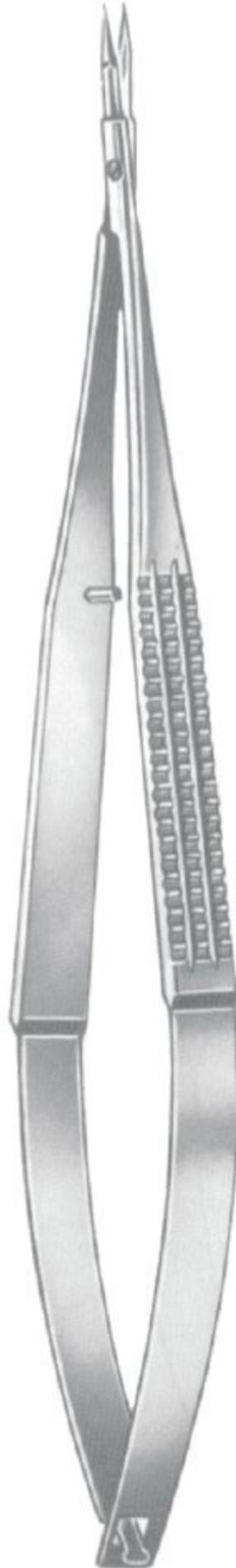

Straight  
 16-4769-16  
 16cm/6 1/4"

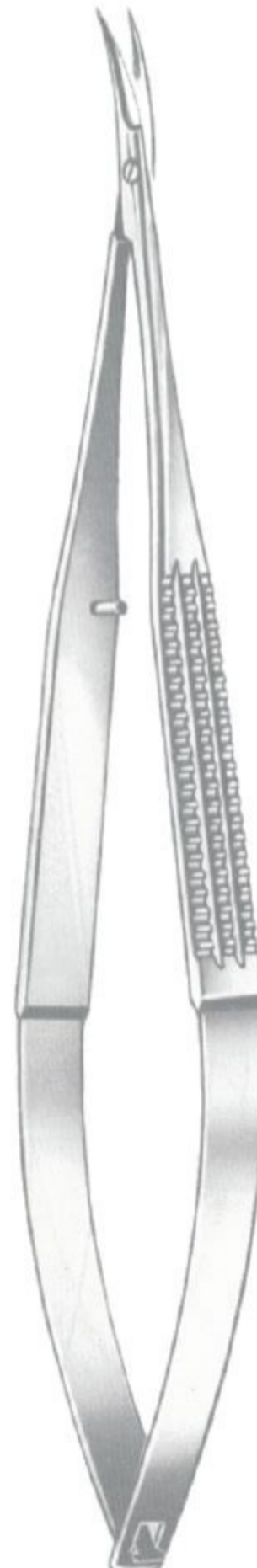

Curved  
 16-4770-16  
 16cm/6 1/4"



**Millesi**  
 Straight  
 16-4771-16  
 16cm/6 1/4"

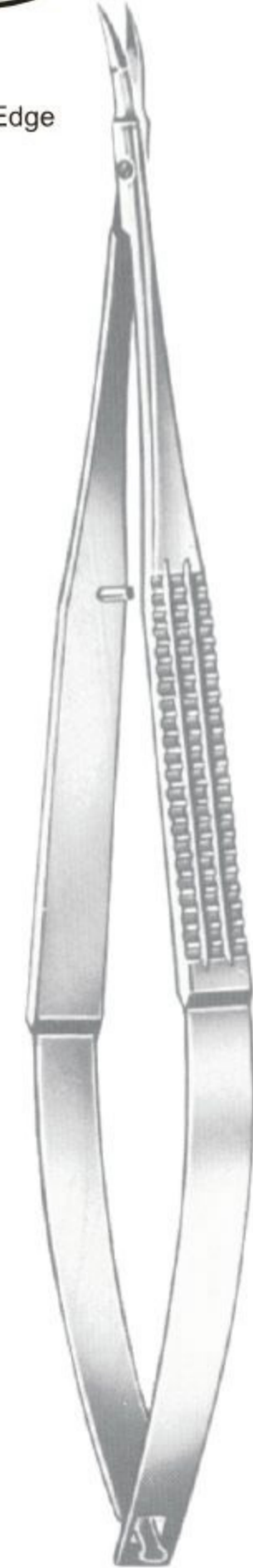

**Millesi**  
 Curved  
 16-4772-16  
 16cm/6 1/4"

- Micro Scissors ●— EN
- Mikro-Scheren ●— DE
- Micro-Tijeras ●— ES



Straight  
 16-4773-18  
 18.5cm/7 1/4"



Curved  
 16-4774-18  
 18.5cm/7 1/4"



Angular  
 16-4775-18  
 18.5cm/7 1/4"



Straight  
 16-4776-23  
 23cm/9"

Dissecting Scissors



Straight  
 16-4777-14  
 14.5cm/5 3/4"



Curved  
 16-4778-14  
 14.5cm/5 3/4"



Curved  
 16-4779-14  
 14.5cm/5 3/4"