

- EN** Bone Surgery
- DE** Knochenchirurgie
- ES** Cirugía ósea

Page 243 to 314





Mead
 12-3501-17 17.0cm
 26mm Ø, 320 g (11¼ oz)



Partsch
 12-3502-18 18.0cm
 22mm Ø, 200 g (7 oz)



12-3503-30
 30mm Ø, 510 g



12-3504-25 250 g
 12-3505-45 450 g
 12-3506-90 900 g
 26.5cm



12-3507-18 18.5cm
 25mm Ø 135 g



lead filled

12-3508-19 19.0cm
 22mm Ø 155 g



Hajek
 12-3509-22 22.0cm
 27mm Ø 130 g

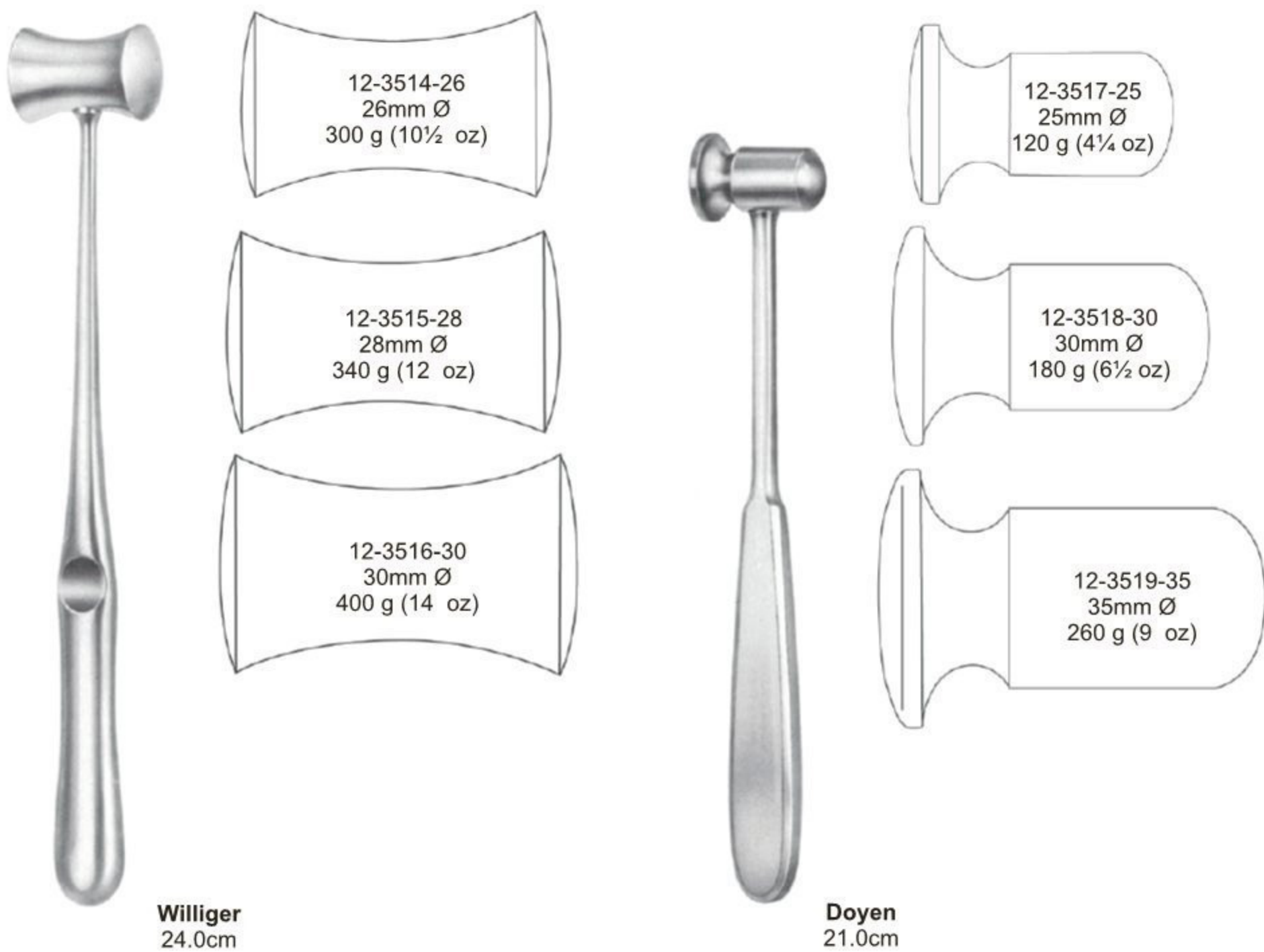
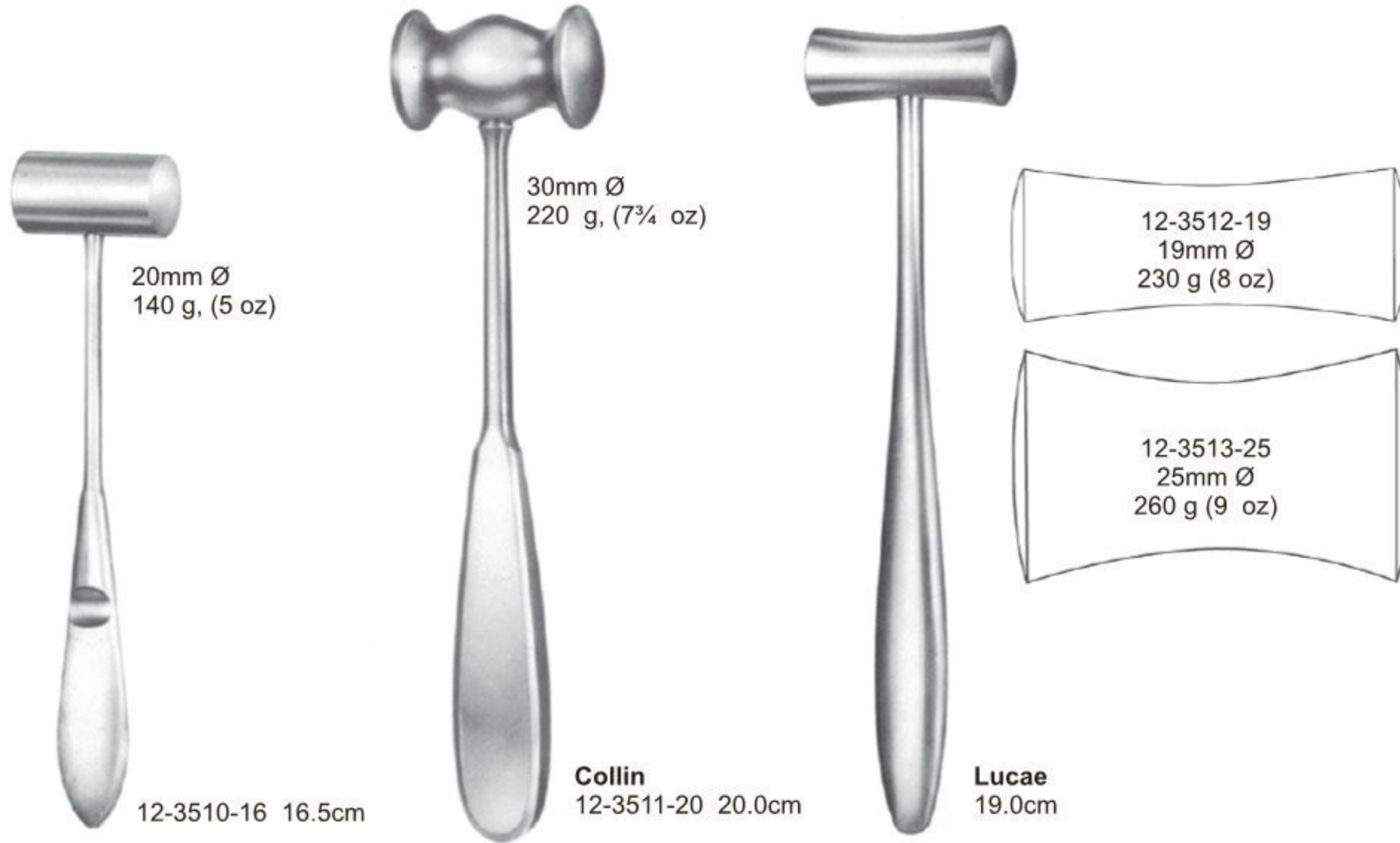



Gerzog
 12-3520-18 18.0cm
 250 g

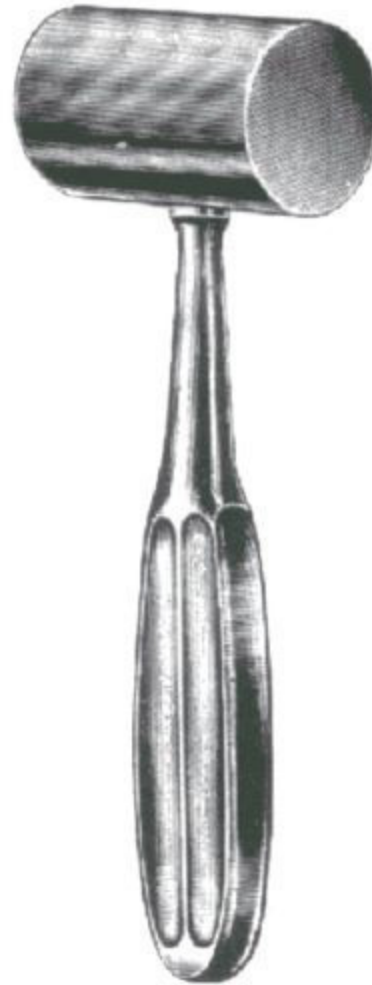

Kirk
 12-3521-19 19.0cm
 750 g

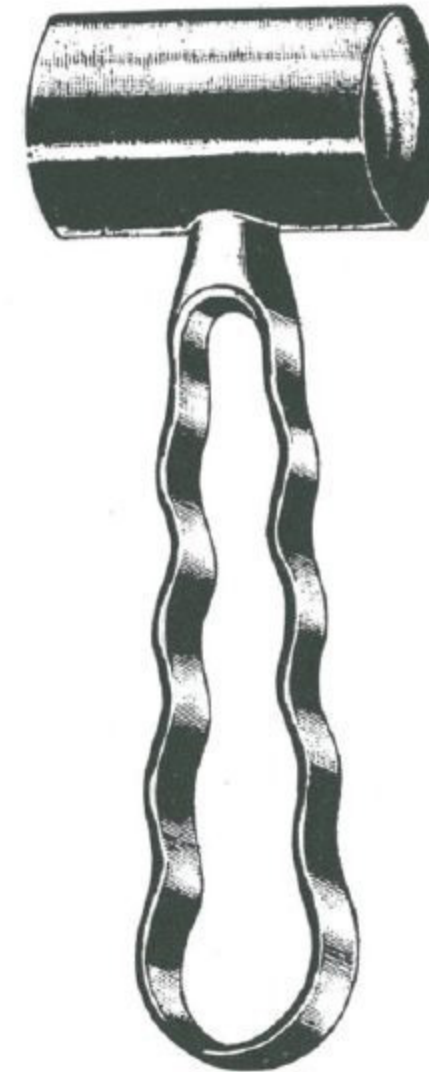

Heath
 18.0cm
 12-3522-35 35mm Ø (28 oz)
 12-3522-40 40mm Ø (36 oz)



12-3523-26
 26.5cm 530 g (19 oz)



12-3524-24
 24.0cm (30mm Ø 480 g)



12-3525-22
 22.5cm (37mm Ø 370 g)



12-3526-24 24.0cm

Mallets ● EN
 Hämmer ● DE
 Martillos y Mazos ● ES



12-3527-26 26.5cm
 30mm Ø, 510 g (18 oz)



12-3528-26 26.5cm



12-3529-25 26.5cm 250 g (0.55 lbs)
 12-3529-45 26.5cm 450 g (1 lbs)
 12-3529-90 26.5cm 900 g (2 lbs)



mm **Partsch**
 02 12-3530-02
 03 12-3530-03
 04 12-3530-04
 05 12-3530-05
 06 12-3530-06
 07 12-3530-07
 08 12-3530-08
 13.5 cm/5¼"



mm **Partsch**
 12-3531-02
 12-3531-03
 12-3531-04
 12-3531-05
 12-3531-06
 12-3531-07
 12-3531-08
 17 cm/6¾"

12-3532-02
 12-3532-03
 12-3532-04
 12-3532-05
 12-3532-06
 12-3532-07
 12-3532-08
 13.5 cm/5¼"

12-3533-04
 12-3533-06
 12-3533-08
 12-3533-10
 12-3533-12
 12-3533-14
 12-3533-16
 17cm/6¾"



Width

mm
 04 12-3534-04 12-3535-04 12-3536-04
 06 12-3534-06 12-3535-06 12-3536-06
 08 12-3534-08 12-3535-08 12-3536-08
 10 12-3534-10 12-3535-10 12-3536-10
 12 12-3534-12 12-3535-12 12-3536-12
 14 12-3534-14 12-3535-14 12-3536-14
 16 12-3534-16 12-3535-16 12-3536-16
 13.5 cm/5¼"



mm
 06 12-3537-06
 12 12-3537-12
 18 12-3537-18



Mod. USA
 12-3538-06
 12-3538-12
 12-3538-18
 16 cm/6¼"



12-3539-06
 12-3539-12
 12-3539-18



16 cm/6¼"

12-3540-03
 3mm
 12-3540-05
 5mm
 12-3540-07
 7mm
 212-3540-09
 9mm



Passow
 12 cm/4¾"

12-3541-02
 2.5mm
 12-3541-03
 3.5mm



Lexer
 27.5 cm/10¾"

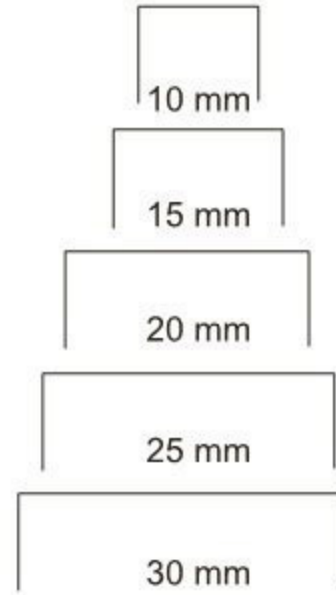

- 12-3542-10
- 12-3542-15
- 12-3542-20
- 12-3542-25
- 12-3542-30

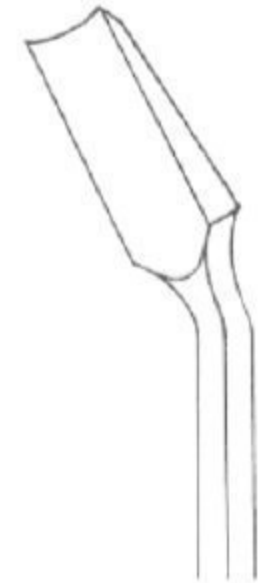

- 12-3543-10
- 12-3543-15
- 12-3543-20
- 12-3543-25
- 12-3543-30



Cloward
 24 cm/9½"

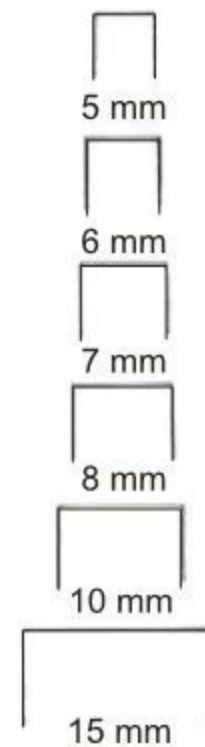

- 12-3544-05
- 12-3544-06
- 12-3544-07
- 12-3544-08
- 12-3544-10
- 12-3544-15



- 12-3545-05
- 12-3545-06
- 12-3545-07
- 12-3545-08
- 12-3545-10
- 12-3545-15

- EN —● Bone Chisels and Gauges
- DE —● Meißel und Osteotome
- ES —● Cinceles y Gubias para huesos



Alexander
18 cm/7"

	mm	
12-3546-04	04	12-3547-04
12-3546-06	06	12-3547-06
12-3546-08	08	12-3547-08
12-3546-10	10	12-3547-10
12-3546-12	12	12-3547-12
12-3546-14	14	12-3547-14



Hoke

14 cm/5½"

	mm	
12-3548-02	2	12-3549-02
12-3548-03	3	12-3549-03
12-3548-04	4	12-3549-04
12-3548-05	5	12-3549-05
12-3548-06	6	12-3549-06
12-3548-07	7	12-3549-07
12-3548-08	8	12-3549-08



Smith-Petersen
20 cm/8"

mm				
06	12-3550-06	12-3551-06	12-3552-06	12-3553-06
09	12-3550-09	12-3551-09	12-3552-09	12-3553-09
13	12-3550-13	12-3551-13		
14			12-3552-14	12-3553-14
16	12-3550-16	12-3551-16	12-3552-16	12-3553-16
19	12-3550-19	12-3551-19	12-3552-19	12-3553-19
25	12-3550-25	12-3551-25	12-3552-25	12-3553-25
32	12-3550-32	12-3551-32	12-3552-32	12-3553-32



Lambotte

	mm	
12-3554-04	04	12-3555-04
12-3554-06	06	12-3555-06
12-3554-08	08	12-3555-08
12-3554-10	10	12-3555-10
12-3554-13	13	12-3555-13
12-3554-16	16	12-3555-16
12-3554-18	18	12-3555-18
12-3554-20	20	12-3555-20
12-3554-25	25	12-3555-25
12-3554-30	30	12-3555-30
12-3554-38	38	12-3555-38
12-3554-44	44	12-3555-44
12-3554-50	50	12-3555-50

24 cm/9½"

Curved

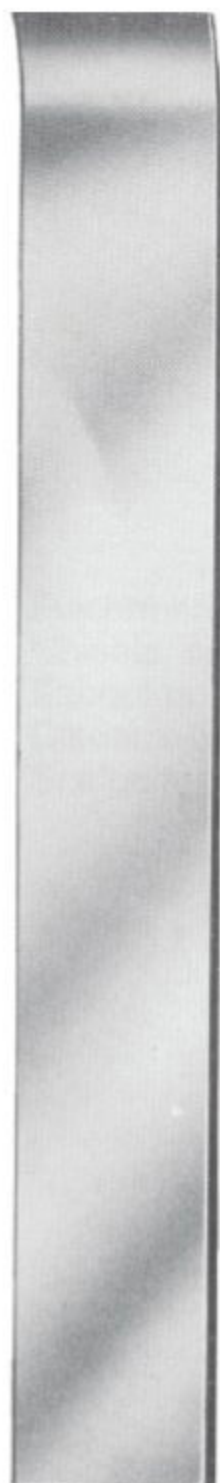

23 cm/9"



Mini-Lambotte

	mm	
12-3556-02	02	12-3557-02
12-3556-03	03	12-3557-03
12-3556-04	04	12-3557-04
12-3556-06	06	12-3557-06
12-3556-08	08	12-3557-08
12-3556-10	10	12-3557-10
12-3556-12	12	12-3557-12
12-3556-15	15	12-3557-15
12.5 cm/5"		17 cm/6¾"



Mini-Lexer

	mm	
12-3558-04	04	12-3559-04
12-3558-06	06	12-3559-06
12-3558-08	08	12-3559-08
12-3558-10	10	12-3559-10
12-3558-12	12	12-3559-12

18 cm/7"



Lexer

	mm	
12-3560-05	05	12-3561-05
12-3560-07	07	12-3561-07
12-3560-10	10	12-3561-10
12-3560-15	15	12-3561-15
12-3560-20	20	12-3561-20
12-3560-25	25	12-3561-25
12-3560-30	30	12-3561-30

22 cm/8¾"





Chisel
12-3562-20
24.5 cm/9 3/4"
20 mm



Chisel-Curved
12-3563-20
26.5 cm/10 1/2"
20 mm

Gouge for the
removing of
broken screws



12-3564-22
22 cm/8 3/4"

Bone Chisels and Gauges ●— EN
 Meißel und Osteotome ●— DE
 Cinceles y Gubias para huesos ●— ES



Zielke
 23 cm/9"
 5.5 mm
 9.0 mm

12-3565-05
 12-3565-09



Width

mm	12-3566-06	12-3567-06	12-3568-06	12-3569-06	12-3570-06
06	12-3566-06	12-3567-06	12-3568-06	12-3569-06	12-3570-06
08	12-3566-08	12-3567-08	12-3568-08	12-3569-08	12-3570-08
10	12-3566-10	12-3567-10	12-3568-10	12-3569-10	12-3570-10
12	12-3566-12	12-3567-12	12-3568-12	12-3569-12	12-3570-12
15	12-3566-15	12-3567-15	12-3568-15	12-3569-15	12-3570-15
20	12-3566-20	12-3567-20	12-3568-20	12-3569-20	12-3570-20
25	12-3566-25	12-3567-25	12-3568-25	12-3569-25	12-3570-25
30	12-3566-30	12-3567-30	12-3568-30	12-3569-30	12-3570-30

Stille
 20 cm/8"



mm	12-3571-06	12-3572-06	12-3573-06	12-3574-06	12-3575-06
06	12-3571-06	12-3572-06	12-3573-06	12-3574-06	12-3575-06
09	12-3571-09	12-3572-09	12-3573-09	12-3574-09	12-3575-09
13	12-3571-13	12-3572-13	12-3573-13	12-3574-13	12-3575-13
16	12-3571-16	12-3572-16	12-3573-16	12-3574-16	12-3575-16
19	12-3571-19	12-3572-19	12-3573-19	12-3574-19	12-3575-19
25	12-3571-25	12-3572-25	12-3573-25	12-3574-25	12-3575-25
32	12-3571-32	12-3572-32	12-3573-32	12-3574-32	12-3575-32

Hibbs
 24 cm/9½"



12-3579-01

12-3579-02



12-3579-03

Cobb
28 cm/11"

12-3579-04

mm **Lexer**
 05 12-3576-05
 10 12-3576-10
 15 12-3576-15
 28 cm/11"

Lexer
 12-3577-05
 12-3577-10
 12-3577-15
 25 cm/10"

Lexer
 12-3578-05
 12-3578-10
 12-3578-15
 25 cm/10"

Bone Files ● EN
 Knochenfeile ● DE
 Lima para huesos ● ES



Putti
 12-3580-30
 30 cm/12"



Putti
 12-3581-27
 27 cm/10½"



12-3582-25
 25 cm/10"



12-3583-24
 24 cm/9½"



12-3584-22
 22 cm/8¾"



Width

Lambotte
 21 cm/8¼"

	mm
12-3585-05	05
12-3585-10	10
12-3585-15	15
12-3585-20	20
12-3585-25	25



Schneider
 12-3586-17
 13 mm
 17.5 cm/7"



Schneider-Sauerbruch
 12-3587-19
 13 mm
 19 cm/7½"



Alexander
 12-3588-20
 20 cm/8"



Jansen
 12-3589-16
 15 mm
 16.5 cm/6½"



Seldin
 12-3590-19
 19 cm/7½"



Davidson-Alexander
 12-3591-29
 29 cm/11½"



Williger
 12-3592-29
 13 cm/5"

Periosteal Raspatories ● EN
 Raspatorien ● DE
 Legras-Periostótomos ● ES

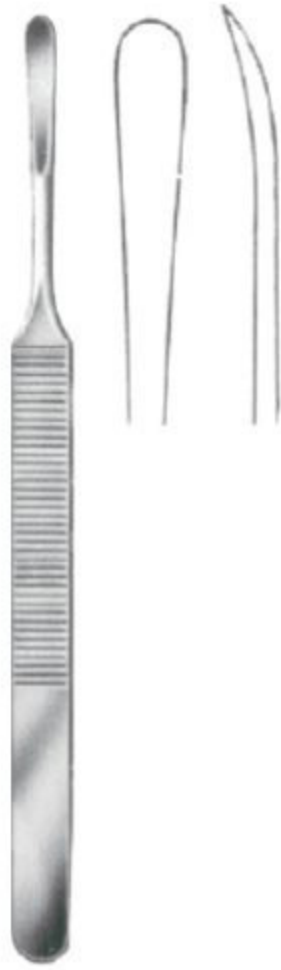

Konig
 12-3593-15
 15.5 cm/6"
 5 mm



Williger
 12-3594-16
 16 cm/6¼"



Adson
 17 cm/6¾"



12-3595-01



12-3595-02



12-3595-03



12-3595-04



12-3596-06
 6 mm

17 cm/6¾"

12-3597-08
 8 mm

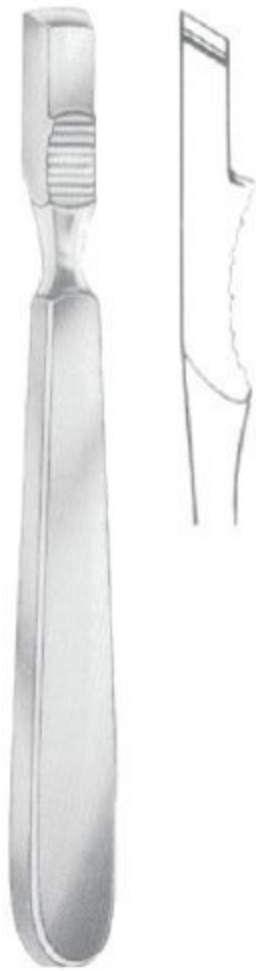

Farabeuf
 12-3598-15
 15 cm/6"



Farabeuf
 12-3599-15
 15 cm/6"



Farabeuf-Collin
 12-3600-15
 15.5 cm/6"
 11 mm



Farabeuf-Collin
 12-3601-15
 15.5 cm/6"
 11 mm



Farabeuf
 12-3602-19
 19 cm/7½"
 13 mm

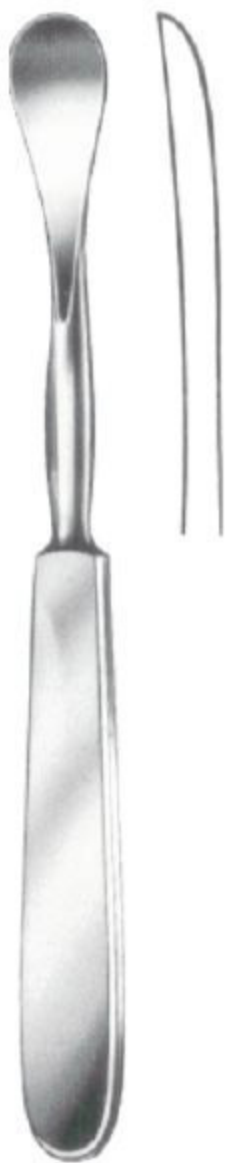

Sedillot
 12-3603-18
 18 cm/7"
 18 mm



Sedillot
 12-3604-21
 21 cm/8¼"
 15 mm



Langenbeck
 12-3605-19
 19 cm/7½"



Langenbeck
 12-3606-18
 18 cm/7"

Periosteal Raspatories ● EN
 Raspatorien ● DE
 Legras-Periostótomos ● ES



Overholt
 12-3607-29
 29.5 cm/11½"



Overholt
 12-3608-29
 29.5 cm/11½"



Overholt
 12-3609-28
 28.5 cm/11¼"



Hylin
 12-3610-01
 12-3610-02
 12-3610-03
 14.5 cm/5¾"



Matson
 12-3611-22
 22 cm/8¾"



Semb



12-3612-01
 19.5 cm/7½"
 12 mm



12-3613-02
 19.5 cm/7½"
 12 mm



12-3614-03
 19.5 cm/7½"
 12 mm



12-3615-04
 22 cm/8¾"
 13 mm



12-3616-05
 21.5 cm/8½"
 13 mm



12-3617-06
 22 cm/8½"
 15 mm



12-3618-07
 22 cm/8½"
 15 mm



Doyen
 17 cm/6¾"

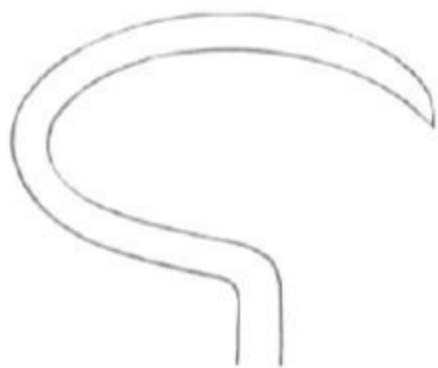

12-3619-01

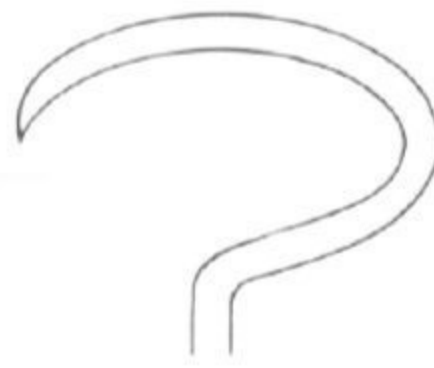

12-3619-02



12-3620-01



12-3620-02



12-3621-01



Doyen
 24 cm/9½" 12-3622-02

Periosteal Raspatories ● EN
 Raspatorien ● DE
 Legras-Periostótomos ● ES



12-3623-04
4 mm



12-3623-06
6 mm



12-3623-08
8 mm



Cobb
24 cm/9½"



12-3623-10
10 mm



12-3623-13
13 mm



12-3623-19
19 mm



12-3623-25
25 mm



12-3624-01
 19 cm/7½"
 6 mm



12-3625-02
 18.5 cm/7¼"
 3 mm



12-3626-03
 18.5 cm/7¼"
 6 mm



12-3627-04
 18.5 cm/7¼"
 6 mm

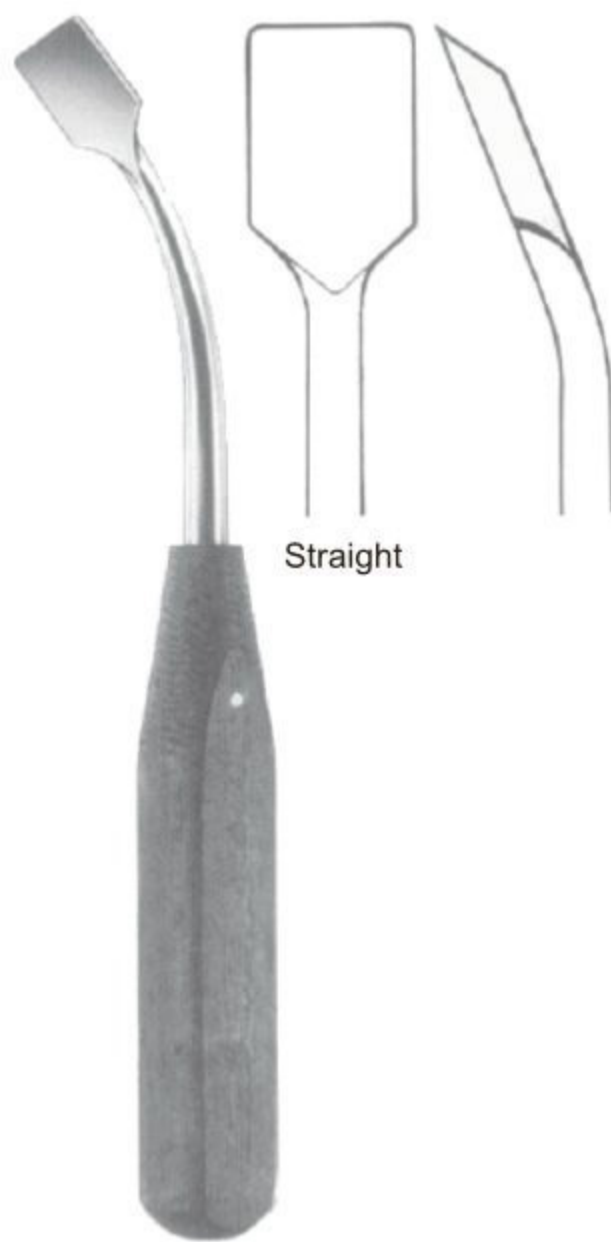

12-3628-05
 18.5 cm/7¼"
 13 mm



12-3629-06
 19.5 cm/7¾"
 14 mm



12-3630-07
 18.5 cm/7¼"
 14 mm



12-3631-08
 20 cm/8"
 20 mm

Periosteal Raspatories ●— EN
 Raspatorien ●— DE
 Legras-Periostótomos ●— ES



12-3632-20
 27.5 cm/10¾"
 20 mm



Wagner

8 mm 12-3633-08 33 cm/13"
 17 mm 12-3633-17 33 cm/13"



Cobb

10 mm 12-3634-10 25 cm/10"
 13 mm 12-3634-13 25 cm/10"
 19 mm 12-3634-19 25 cm/10"
 25 mm 12-3634-25 25 cm/10"



Cobb

10 mm 12-3635-10 28 cm/11"
 13 mm 12-3635-13 28 cm/11"
 19 mm 12-3635-19 28 cm/11"



Hoen

12-3636-07
 16 cm/6¼"
 7 mm

12-3636-15
 18.5 cm/7¼"
 15 mm

12-3636-20
 19 cm/7½"
 20 mm



Yankauer
 12-3637-18
 18 cm/7"



Langenbeck
 12-3638-20
 20 cm/8"
 8 mm



Langenbeck
 12-3639-20
 20 cm/8"
 10 mm



Langenbeck
 12-3640-23
 23 cm/9"
 11 mm



Mass. Gen. Hosp.
 12-3641-15
 15 cm/6"



Williger
 12-3642-17
 17 cm/6¾"
 5.5 mm



Williger
 12-3643-16
 16 cm/6¼"



Quervain
 12-3644-20
 20 cm/8"

Elevators ●— EN
 Elevatorien ●— DE
 Elevadores ●— ES



12-3645-16
 16 cm/6 1/4"



Width
Key
 6 mm 12-3646-06 19 cm/7 1/2"
 12 mm 12-3646-12 19 cm/7 1/2"
 19 mm 12-3646-19 19 cm/7 1/2"
 25 mm 12-3646-25 19 cm/7 1/2"



Konig
 12-3647-15
 15 cm/6"
 4.5 mm



Konig
 12-3648-15
 15 cm/6"
 4.5 mm



Alderdyce
 12-3649-21
 21 cm/8 1/4"



McDonald
 12-3650-19
 19 cm/7 1/2"



Watson-Cheyne
 12-3651-19
 17.5 cm/7"



Sebileau
 12-3652-17
 17 cm/6 3/4"



12-3653-14
 14 cm/5½"
 2.8 mm



12-3654-15
 15 cm/6"
 5 mm



12-3655-15
 15 cm/6"
 7 mm

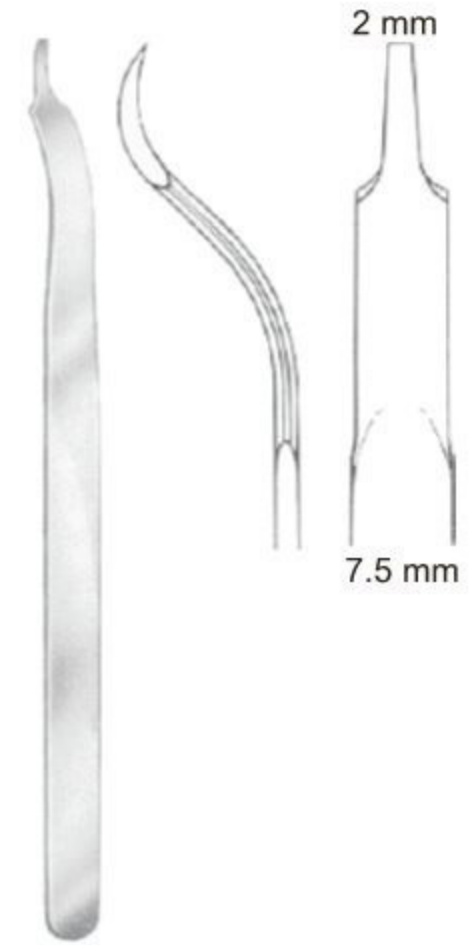

Buck-Gramcko
 12-3656-15
 15 cm/6"

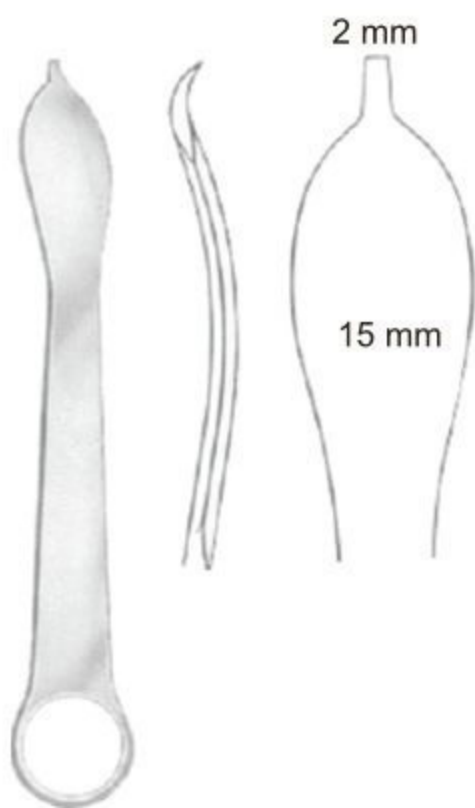

12-3657-12
 12.5 cm/5"



Mini-Hohmann
 12-3658-06
 16 cm/6¼"
 6 mm



12-3658-06
 6 mm



12-3658-08
 8 mm

Bone Levers ●— EN
 Knochenhebel ●— DE
 Elevadores para huesos ●— ES



12-3659-17
 17 mm

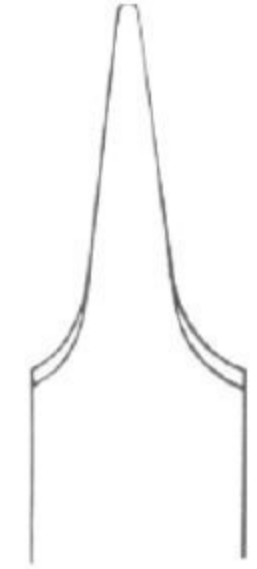

12-3660-17
 17 mm



12-3661-26
 26.5 cm/10½"
 24 mm



Lange-Hohmann
 12-3662-26
 26 cm/10¼"
 22 mm



Hohmann
 12-3663-22
 22 cm/8¾"
 8 mm



Hohmann
 12-3664-24
 24 cm/9½"
 14mm



Hohmann
 12-3665-26
 26 cm/10¼"
 22 mm

Hohmann
 12-3666-28
 28 cm/11"
 33 mm

Hohmann
 12-3667-24
 24 cm/9½"
 43 mm

Hohmann
 12-3668-24
 24.5 cm/9¾"
 43 mm

Hohmann
 12-3669-24
 24 cm/9½"
 70 mm

Hohmann
 12-3670-22
 22 cm/8¾"
 18 mm



Lange-Hohmann modif
 30 mm 12-3671-26 26.5 cm/10½"
 33 mm 12-3671-29 29.0 cm/11½"

Hohmann-Aldinger
 12-3672-27
 27 cm/10½"

Schumacher (Wagner)
 12-3673-34
 34.5 cm/13½"

Schumacher
 12-3674-29
 29 cm/11½"



Smillie
 14 cm/5½"

12-3675-01
 32x19 mm

12-3675-02
 48x19 mm

12-3675-03
 57x19 mm



12-3675-04
 52x13 mm



12-3675-05
 12x13 mm

Spinal retractors



12-3676-01
 75x30 mm

12-3676-02
 100x30 mm

Taylor
 17 cm/6½"



12-3677-21
 21.5 cm/8½"

Meniscus retractors



Blount
 12-3678-17
 17.5 cm/7"

Bone Levers ● EN
 Knochenhebel ● DE
 Elevadores para huesos ● ES



Murphy-Lane
 12-3679-32
 32 cm/12½"



Chandler

Length	Width	
18 cm	13 mm	12-3680-13
20 cm	19 mm	12-3680-19
23 cm	25 mm	12-3680-23
25 cm	30 mm	12-3680-30



Blount
 12-3681-26
 26 cm/10¼"



Blount
 12-3682-26
 26 cm/10¼"



Bennett
 24 cm/9½" 12-3683-44 44 mm
 12-3683-64 64 mm



Smillie
 12-3684-17
 17 cm/6¾"



Smillie
 12-3685-17
 17 cm/6¾"



Smillie
 12-3686-17
 17 cm/6¾"



Salenius
 12-3687-22
 22 cm/8¾"



Salenius
 12-3688-22
 22 cm/8¾"



12-3689-17
 17.5 cm/7"



Neff
 12-3690-21
 21.5 cm/8½"



Canad-Modell
 12-3691-01 20 cm/8"



12-3692-02



Bircher
 12-3693-20
 20.5 cm/8"

Drill guide and dura protecting forceps



Adson
 12-3694-15
 15 cm/6"

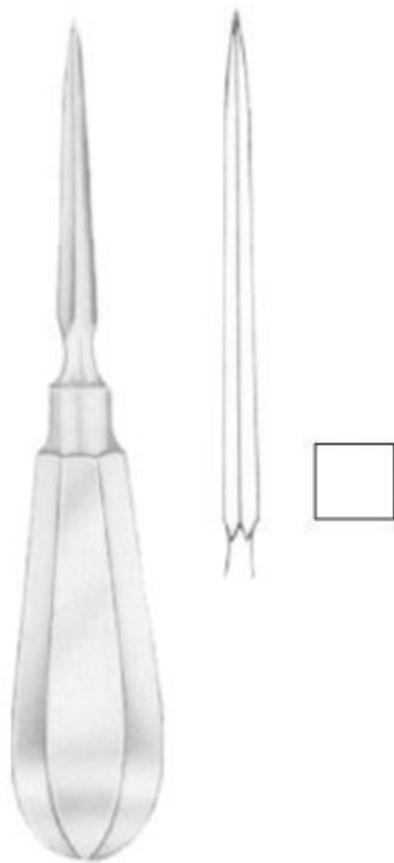

12-3695-14
 14 cm/5½"



Perthes
 12-3696-21
 21 cm/8¼"



12-3697-14
 14 cm/5½"

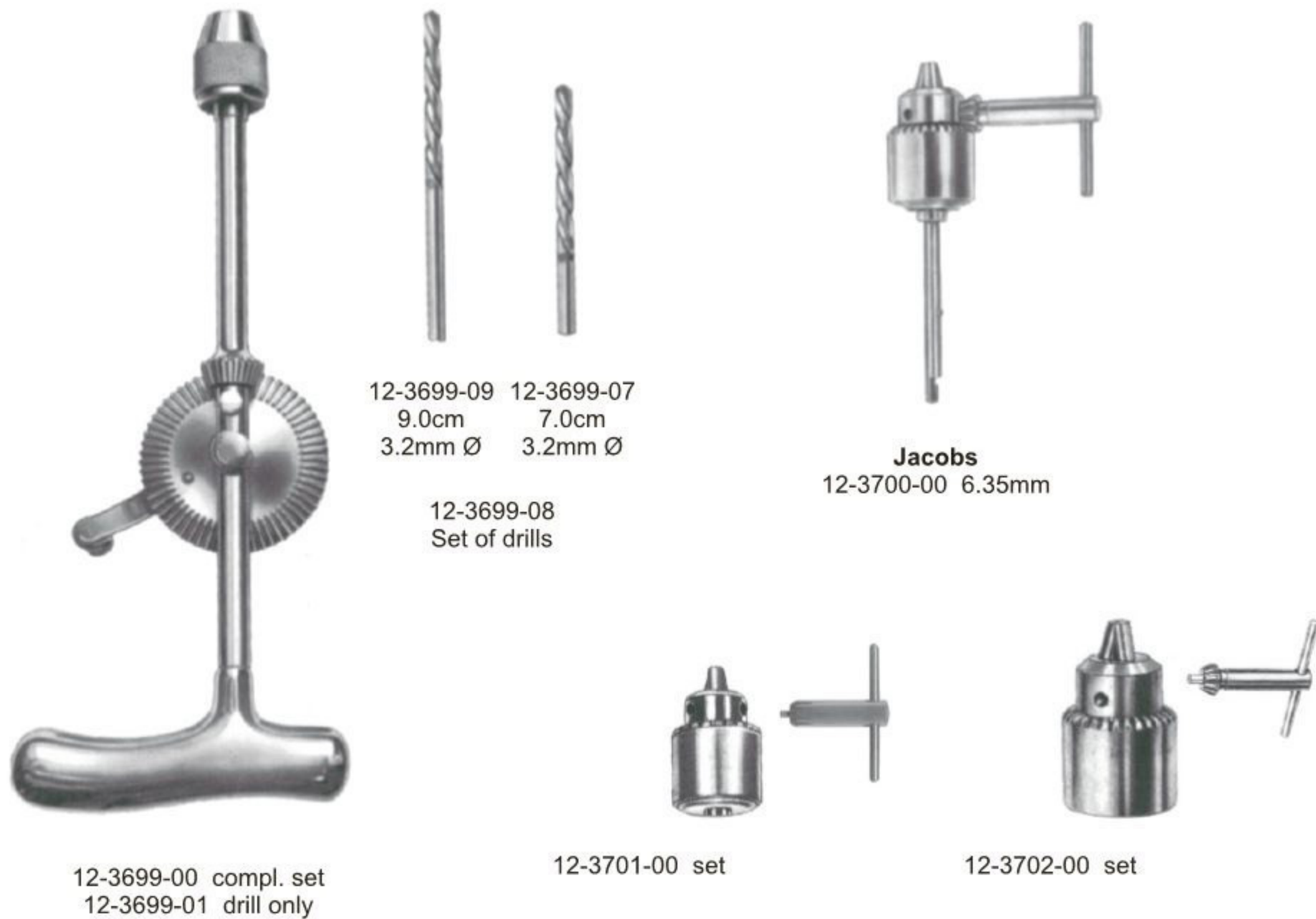
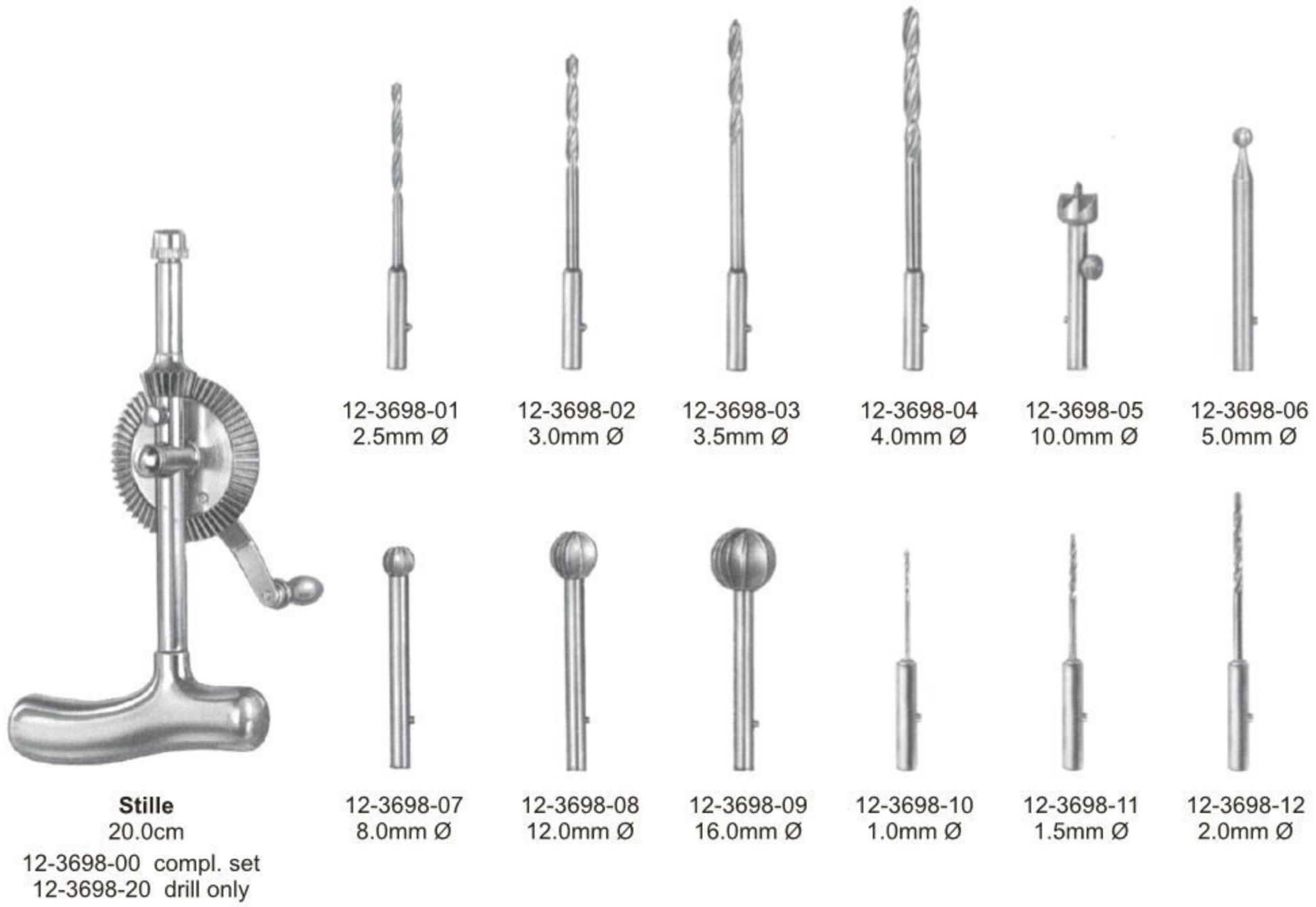

Hand Drills ● EN
 Handbohrapparate ● DE
 Perforadores de mano ● ES



Stille-Sherman
 24.0cm
 12-3703-00 compl. set
 12-3703-24 drill only



12-3703-25 2.5mm Ø
 12-3703-30 3.0mm Ø
 12-3703-35 3.5mm Ø



Hudson
 12-3704-00 compl. set / 6
 (12-3704,01,
 02,03,07,09)
 12-3704-27 handle only



12-3704-01 9mm Ø
 12-3704-02 14mm Ø
 12-3704-03 16mm Ø
 12-3704-04 22mm Ø



Cushing 12-3704-05 14mm Ø
 12-3704-06 2mm Ø
Mckenzie 12-3704-07 13mm Ø
Errico 12-3704-08 16mm Ø
 12-3704-09



12-3705-00



12-3706-00



12-3707-00



12-3708-01

12-3708-00 complete set



12-3709-01

12-3709-02



12-3709-03

Kirschner
 12-3709-00 complete set

Hand Drills ● EN
 Handbohrapparate ● DE
 Perforadores de mano ● ES

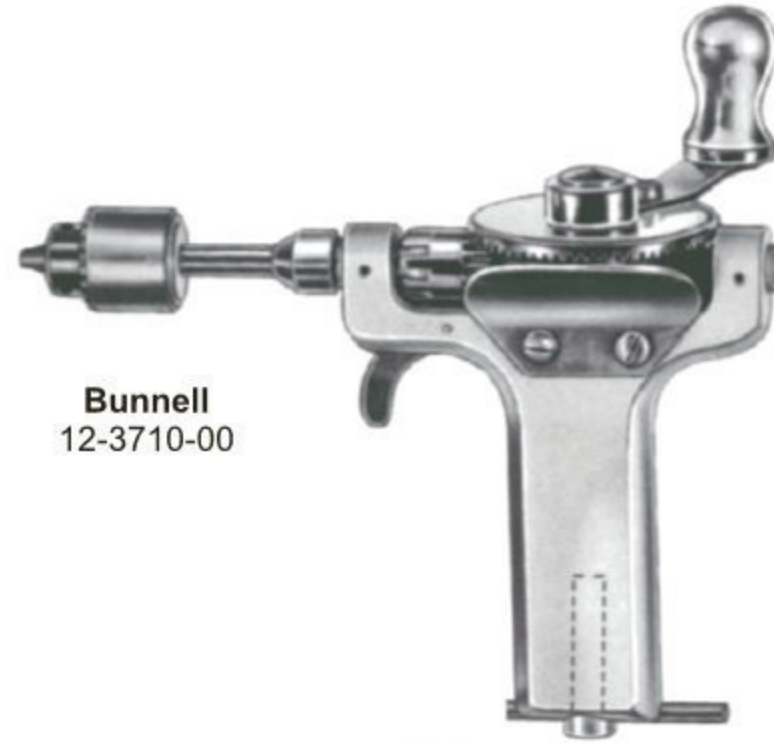

Bunnell
 12-3710-00



Ralk
 12-3711-00



Ralk-Universal
 12-3712-00 Left hand
 12-3713-00 Right hand



12-3714-00



Spare Saw Blade
 12-3715-12 12mm
 12-3715-15 15mm
 12-3715-18 18mm

Charriere
 12-3715-35 35.0cm



Spare Saw Blade
 12-3716-03 3mm
 12-3716-05 5mm
 12-3716-07 7mm

Helferich-Bier
 12-3716-39 39.0cm



Lindemann
 12-3717-20 20.0cm



Langenbeck
 12-3718-23 23.0cm

12-3719-06 6mm
 12-3719-08 8mm
 12-3719-12 12mm
 12-3719-15 15mm
 12-3719-18 18mm

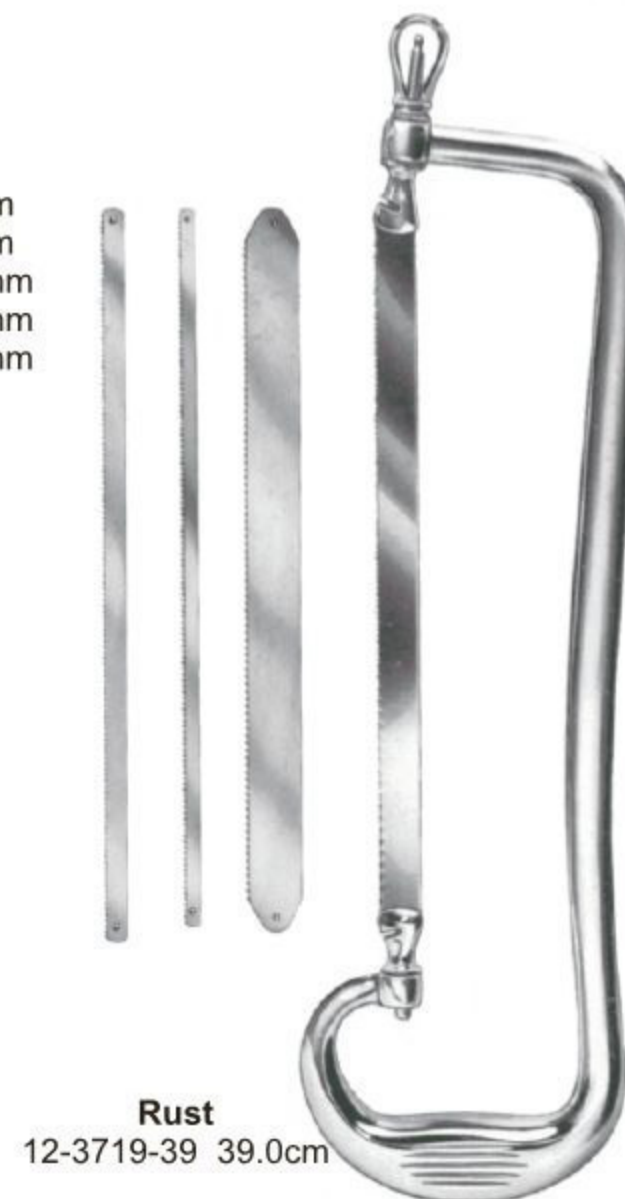

Rust
 12-3719-39 39.0cm



Charriere
 12-3720-27 27.0cm
 12-3720-30 30.0cm
 12-3720-34 34.0cm



Satterlee
 12-3721-31 31.0cm



Charriere
 12-3722-27 27.0cm
 12-3722-30 30.0cm



Satterlee
 12-3723-31
 31.0cm

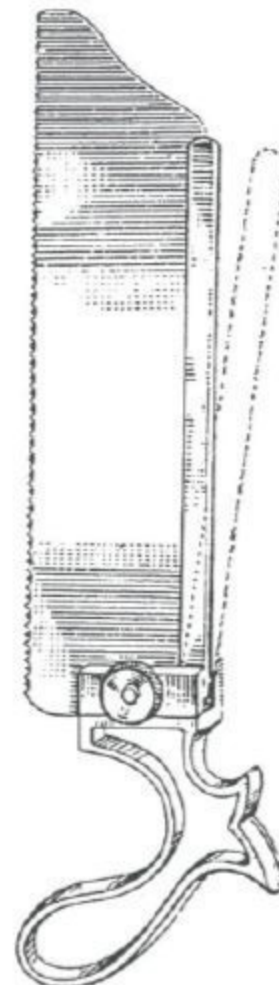

12-3724-23
 23.0cm

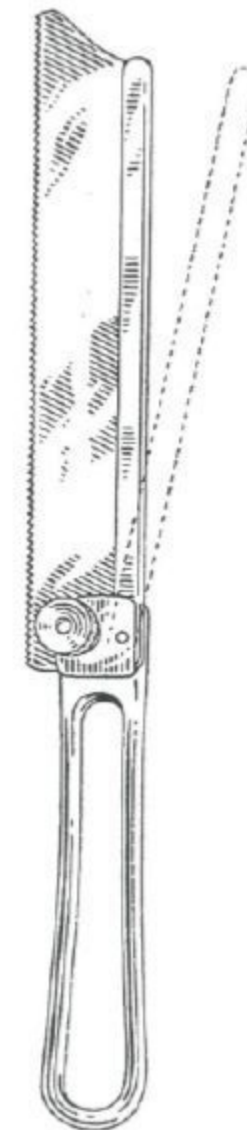

12-3725-19
 19.0cm

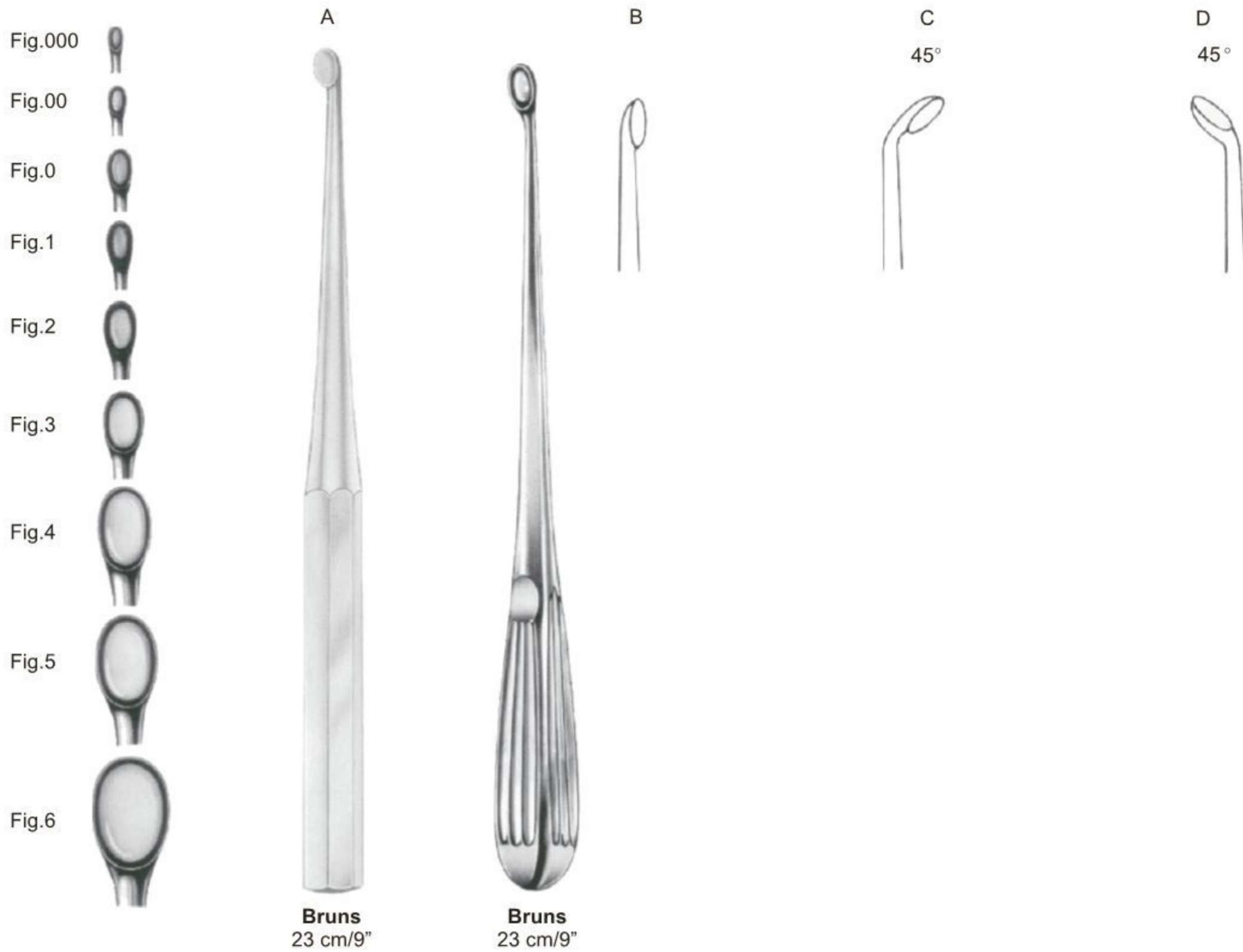

Fig.	A	B	C	D
000	12-3726-30	12-3727-30	12-3728-30	12-3729-30
00	12-3726-20	12-3727-20	12-3728-20	12-3729-20
0	12-3726-10	12-3727-10	12-3728-10	12-3729-10
1	12-3726-01	12-3727-01	12-3728-01	12-3729-01
2	12-3726-02	12-3727-02	12-3728-02	12-3729-02
3	12-3726-03	12-3727-03	12-3728-03	12-3729-03
4	12-3726-04	12-3727-04	12-3728-04	12-3729-04
5	12-3726-05	12-3727-05	12-3728-05	12-3729-05
6	12-3726-06	12-3727-06	12-3728-06	12-3729-06

Bone Curettes ● EN
 Scharfe Löffel ● DE
 Cucharillas cortantes ● ES



Volkmann
 17 cm/6¾"



- Fig.
 0000 12-3730-40
 000 12-3730-30
 00 12-3730-20
 0 12-3730-10
 1 12-3730-01
 2 12-3730-02
 3 12-3730-03
 4 12-3730-04
 5 12-3730-05
 6 12-3730-06



Volkmann
 17 cm/6¾"

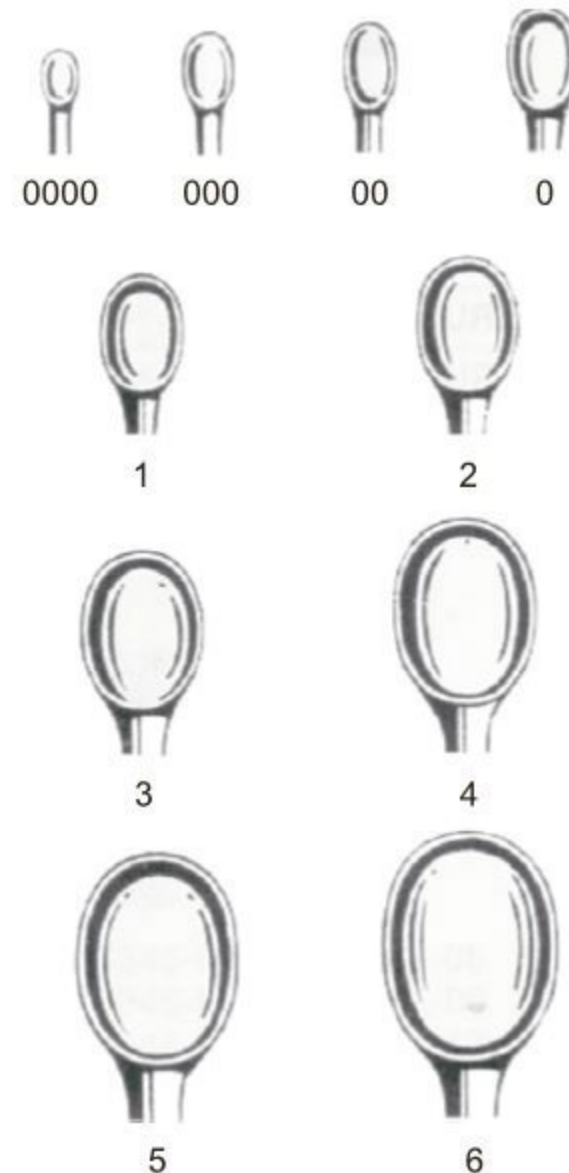

- Fig.
 0000 12-3731-40
 000 12-3731-30
 00 12-3731-20
 0 12-3731-10
 1 12-3731-01
 2 12-3731-02
 3 12-3731-03
 4 12-3731-04
 5 12-3731-05
 6 12-3731-06



12-3732-21
 21 cm/8 1/4"



Epstein



Spinal



Spinal

Fig.	12-3733-30	12-3734-30	12-3735-30
000	12-3733-30	12-3734-30	12-3735-30
00	12-3733-20	12-3734-20	12-3735-20
0	12-3733-10	12-3734-10	12-3735-10
1	12-3733-01	12-3734-01	12-3735-01
2	12-3733-02	12-3734-02	12-3735-02
3	12-3733-03	12-3734-03	12-3735-03
4	12-3733-04	12-3734-04	12-3735-04
5	12-3733-05	12-3734-05	12-3735-05
6	12-3733-06	12-3734-06	12-3735-06
	20 cm/8"	20 cm/8"	20 cm/8"

Bone Currettes ● EN
 Scharfe Löffel ● DE
 Cucharillas cortantes ● ES



	Volkman		Volkman
Length	Oval/Oval		Oval/Round
cm	in		
13	5"	12-3736-13	12-3737-13
14	5½"	12-3736-14	
16	6¼"		12-3737-16
17	6¾"	12-3736-17	
20	8"	12-3736-20	12-3737-20

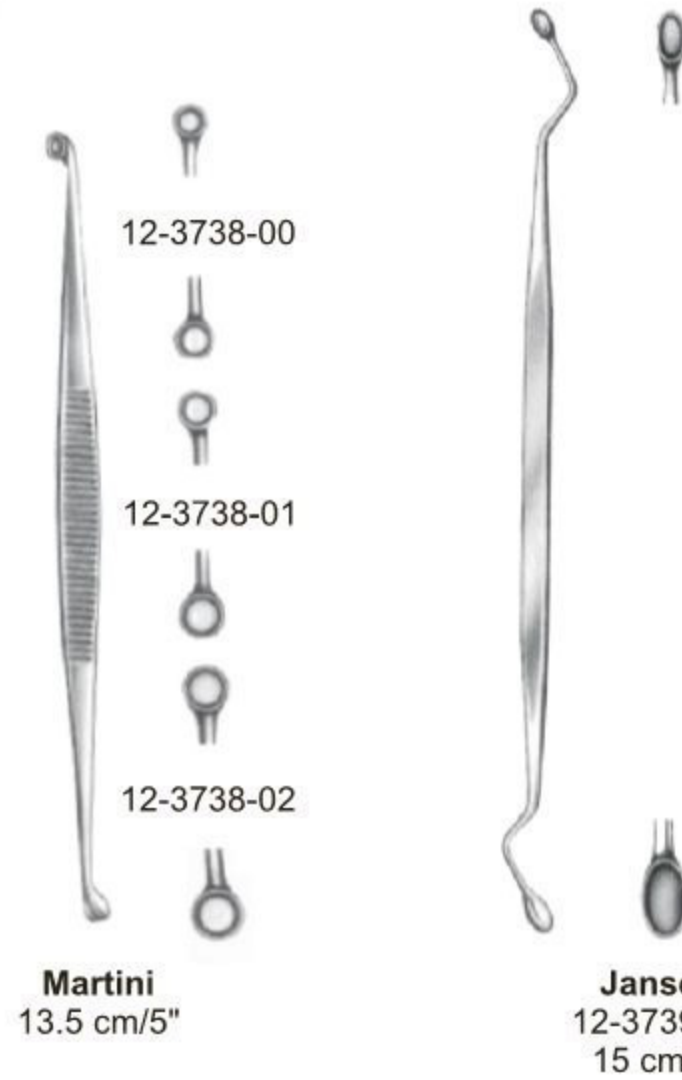

Jansen
 12-3740-16
 16 cm/6¼"



Williger
 13.5 cm/5"



Jacobson
 12-3742-13
 13 cm/5"



Janson
 12-3743-15
 15 cm/6"



Barth
 12-3744-18
 18 cm/7"



Schede
 17 cm/6¾"

Fig.	
000	12-3745-30
00	12-3745-20
0	12-3745-10
1	12-3745-01
2	12-3745-02
3	12-3745-03
4	12-3745-04



Williger
 17.5 cm/7"

00	00
0	0
1	1
2	2
Straight, Oval	Straight
12-3746-20	Fig. 12-3747-20
12-3746-10	0 12-3747-10
12-3746-01	1 12-3747-01
12-3746-02	2 12-3747-02



12-3748-01

Uffenorde
 17 cm/6¾"



12-3749-02

Bone Curettes ●— EN
 Scharfe Löffel ●— DE
 Cucharillas cortantes ●— ES



Bruns	Fig.	Spratt
12-3750-30	000	12-3751-30
12-3750-20	00	12-3751-20
12-3750-10	0	12-3751-10
12-3750-01	1	12-3751-01
12-3750-02	2	12-3751-02
12-3750-03	3	12-3751-03
12-3750-04	4	12-3751-04
12-3750-05	5	12-3751-05
12-3750-06	6	12-3751-06

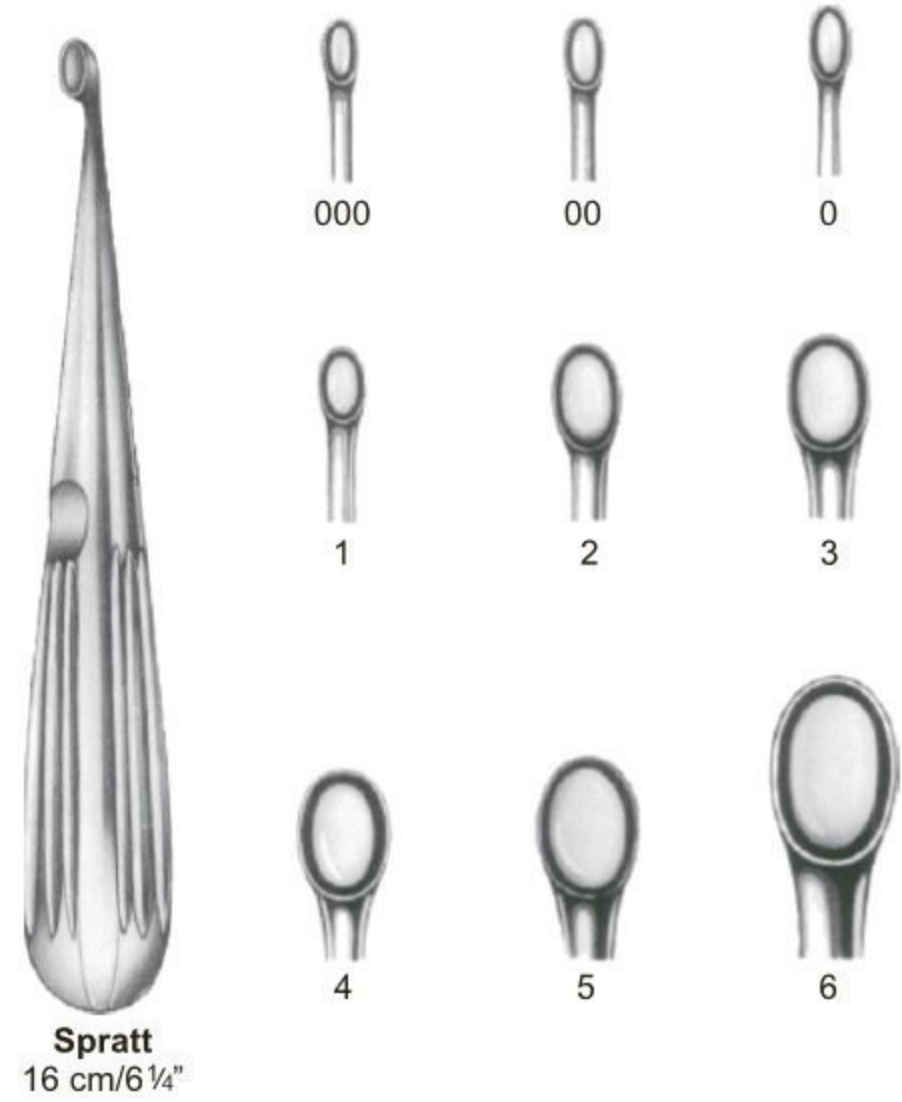

mm	Round	Oval
2	12-3752-02	12-3753-02
3	12-3752-03	12-3753-03
4	12-3752-04	12-3753-04
5	12-3752-05	12-3753-05
6	12-3752-06	12-3753-06
7	12-3752-07	12-3753-07
8	12-3752-08	12-3753-08
10	12-3752-10	12-3753-10
12	12-3752-12	12-3753-12
14	12-3752-14	12-3753-14
	17cm/6 3/4"	22cm/8 1/2"

Swedish pattern

Flexible

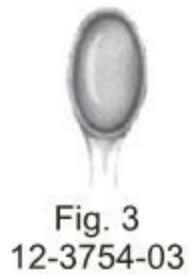

Bone Currettes ● EN
 Scharfe Löffel ● DE
 Cucharillas cortantes ● ES



Volkmann
 27 cm/10½"



Simon
 24 cm/9½"



Simon
 24 cm/9½"



Daubenspeck
 20 cm/8"



Martin
 12-3762-19
 19 cm/7½"



Preston
 12-3763-18
 18 cm/7¼"

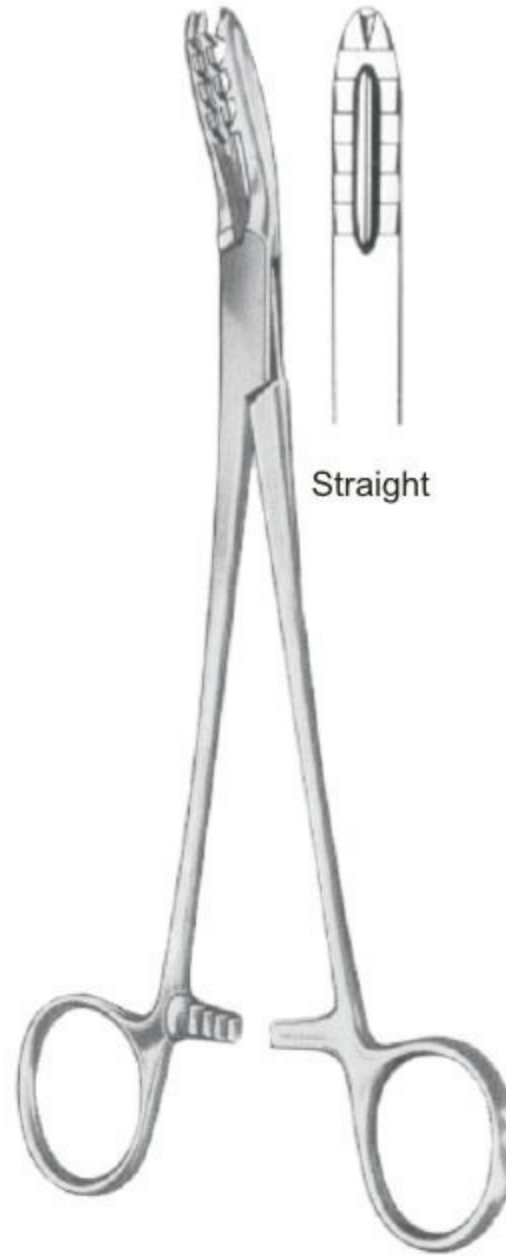

Bircher-Ganske
 12-3764-20
 20 cm/8"



Bircher-Ganske
 12-3765-20
 20 cm/8"



Lewin
 12-3766-17
 17.5 cm/7"



Langenbeck
 12-3767-21
 21 cm/8"



Fergusson
 12-3768-21
 21 cm/8"

Bone Holding Forceps ● EN
 Knochenhaltezangen ● DE
 Pinzas para huesos ● ES



Straight
 12-3769-20
 20 cm/8"



Curved on Falt
 12-3770-20
 20 cm/8"



Van Buren
 12-3771-23
 23 cm/9"



Dingmann
 12-3772-19
 19cm/7½"



Dingmann Modif
 12-3773-19
 19 cm/7½"



Neff
 12-3774-21
 21 cm/8¼"



Semb
 12-3775-19
 19 cm/7½"



Semb
 12-3776-19
 19 cm/7½"



Verbrugge
 12-3777-17
 17.5 cm/7"

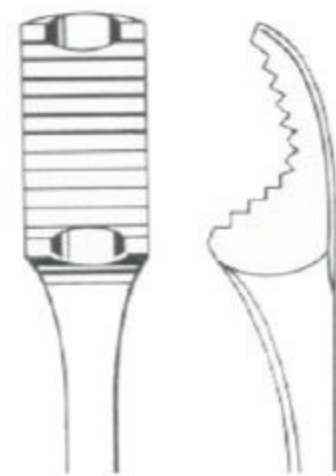

12-3778-25
 25 cm/10"

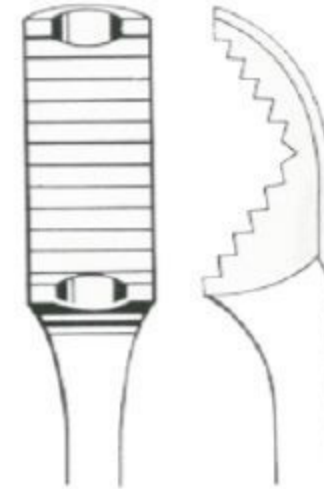

12-3779-26
 26 cm/10¼"
Verbrugge

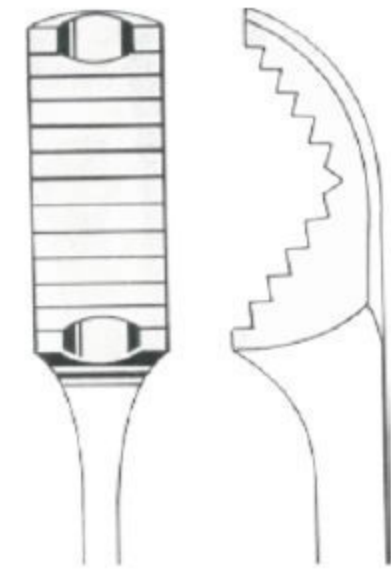

12-3780-27
 27 cm/10½"

Bone Holding Forceps ● EN

Knochenhaltezaugen ● DE

Pinzas para huesos ● ES



12-3781-16
16 cm/6¼"
12-3781-24
24 cm/9½"



Without Ratchet	Kern		With Ratchet
	cm	in	
12-3782-17	17	6¾"	12-3783-17
12-3782-21	21	8¼"	12-3783-21



12-3784-18	18 cm/07"	12-3785-18
12-3784-23	23 cm/09"	12-3785-23
12-3784-25	25 cm/10"	12-3785-25
12-3784-28	28 cm/11"	12-3785-28



Hey Groves
12-3786-21 21.0 cm/8¼"
12-3786-27 27.0 cm/10½"
12-3786-30 30.5 cm/12"



Farabeuf-Lambotte
 12-3787-26
 26 cm/10¼"



Lambotte
 12-3788-19 19 cm/7½"
 12-3788-23 23 cm/9"
 12-3788-26 26 cm/10¼"



Without Ratchet	Lane	With Ratchet
	cm in	
12-3789-33	33 13"	12-3790-33
12-3789-45	45 17¾"	12-3790-45



12-3791-14
 14.5 cm/5¾"



12-3792-12
 12 cm/4¾"

Bone Holding Forceps ● EN
 Knochenhaltezaugen ● DE
 Pinzas para huesos ● ES



12-3793-15 15 cm/6"
 12-3793-19 19 cm/7 1/2"
 12-3793-24 24 cm/9 1/2"
 12-3793-26 26 cm/10 1/4"
 12-3793-28 28 cm/11"



Handles Detachable

Percy
 12-3794-30

Adjustable



Lambotte
 12-3795-22 22 cm/8 3/4"
 12-3795-27 27 cm/10 1/2"
 12-3795-30 30 cm/12"



Farabeuf
 12-3796-23 23 cm/9"
 12-3796-26 26 cm/10 1/4"



Lambotte
 12-3797-22 22.5 cm/9"
 12-3797-25 25.5 cm/10 1/2"
 12-3797-33 33 cm/13 1/2"

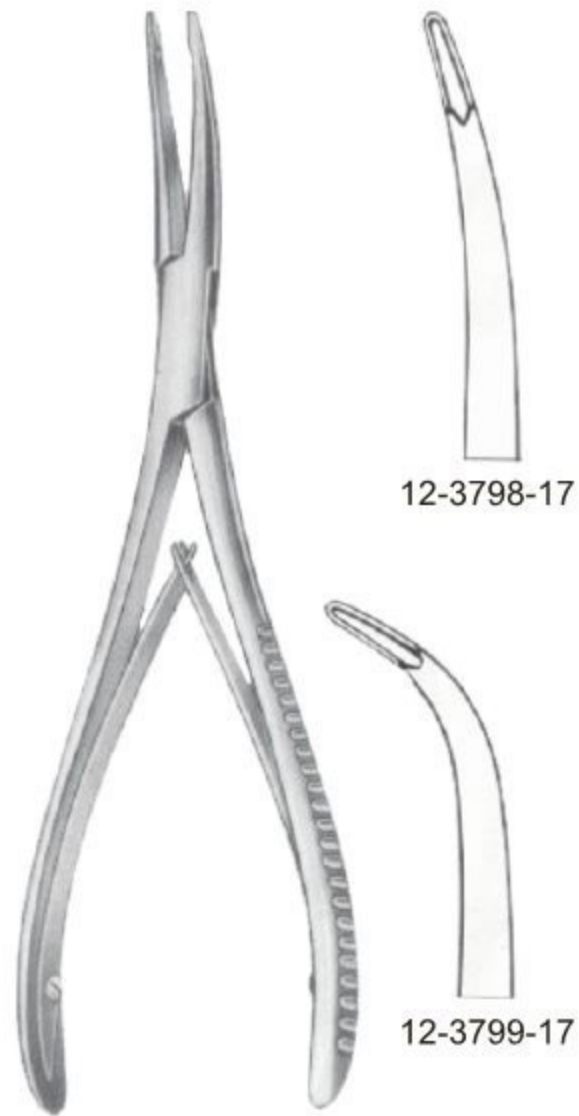

Stellbrink
 17.5 cm/7"



Bane-Hartmann
 12-3800-17
 17.5 cm/7"



Mini-Friedmann
 12-3801-12
 12.5 cm/5"



Friedmann
 12-3802-14
 14 cm/5½"

Bone Holding Forceps, Bone Holding Clamps ● EN

Knochenhaltezaugen, Knochenhalteklammern ● DE

Pinzas para huesos, Pinzas porta-huesos ● ES



12-3803-13
13.5 cm/5¼"



12-3804-20
20 cm/8"



12-3805-17
17 cm/6¾"



Patella Forceps

12-3806-17
17.5 cm/7"



Lowman-Hoglund
12-3807-19
19 cm/7½"



Lowman
12-3808-18 18 cm/7"
12-3808-20 20 cm/8"
12-3808-22 22 cm/8¾"



Lowman
12-3809-12
12 cm/4¾"



Traction Bar

12-3810-18
12-3810-50



Mead
 16.5 cm/6½"

12-3811-16

12-3811-16A



	Lempert	
Straight	cm in	Curved
12-3812-16	16 6¼"	12-3813-16
12-3812-19	19 7½"	12-3813-19



Beyer
 12-3814-18
 18 cm/7"



Jansen
 17.5 cm/7"

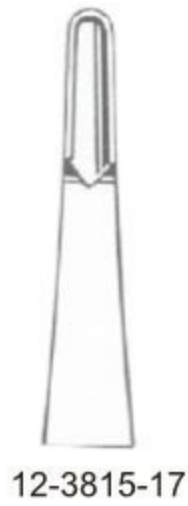

Blumenthal
 15.5 cm/6"

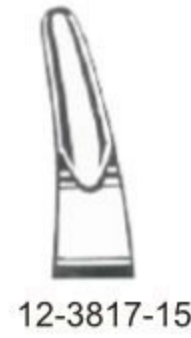

Hakansson
 12-3820-15
 15.5 cm/6"



Friedmann-Delicate
 15 cm/6"



Bacon
 12-3823-20
 20 cm/8"



Cleveland
 12-3824-14 14 cm/5½"
 12-3824-17 17 cm/6¾"



Hartmann
 12-3825-18
 18.5 cm/7¼"



Olivecrona
 12-3826-20
 20 cm/8"



Kleinert-Kutz
 15 cm/6"



12-3827-15
 2 mm



12-3828-15
 3 mm



Bohler
 15 cm/6"



12-3829-15



12-3830-15



**Beyer
 Zaufal-Jansen**
 18 cm/7"



Zaufal-Jansen
 12-3831-18



Beyer
 12-3832-18



Mayfield
 12-3833-17
 17 cm/6¾"



Ruskin
 12-3834-18
 18 cm/7"
 Angled



Straight
 12-3835-18
 18 cm/7"
 12-3835-23
 23 cm/9"



Ruskin

Curved
 12-3836-18
 18 cm/7"
 12-3836-23
 23 cm/9"

Bone Rongeur Forceps ● EN
 Hohlmeißelzangen ● DE
 Pinzas-gubias ● ES



Jansen
 12-3837-18
 18 cm/7"



Luer
 17 cm/6¾"

Straight
 12-3838-17

Curved
 12-3839-17



Luer
 18.5 cm/7¼"

Heavy Pattern

Straight
 12-3840-18

Curved
 12-3841-18



Luer
 15 cm/6"



12-3842-15



12-3843-15



12-3844-15



Adson
 20 cm/8"

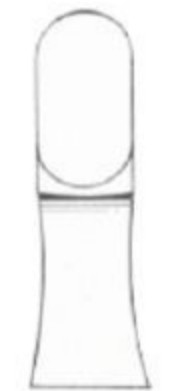

12-3845-20



Stille-Luer
 22 cm/8¾"



Straight
 12-3846-22



Curved
 12-3847-22



Stille-Luer
 27 cm/10½"



12-3848-27



12-3849-27



Semb
 12-3850-23
 23 cm/9"

Bone Rongeur Forceps ● EN
 Hohlmeißelzangen ● DE
 Pinzas-gubias ● ES



12-3853-03
3 mm



12-3853-04
4 mm



12-3853-05
5 mm



12-3853-03A
3 mm



12-3853-04A
4 mm



12-3853-05A
5 mm



Marquardt
 12-3851-20
 20 cm/8"



Rottgen-Ruskin
 12-3852-24
 24 cm/9½"



Smith-Petersen
 24 cm/9½"



Markwalder
 12-3854-20
 20 cm/8"



Straight cm
 12-3855-14 14
 12-3855-17 17
 12-3855-19 19
 12-3855-22 22



Liston in Curved
 5½ 12-3856-14
 6¾ 12-3856-17
 7½ 12-3856-19
 8¾ 12-3856-22



Littauer-Liston
 12-3857-15
 15 cm/6"



Cleveland
 12-3858-15 15 cm/6"
 12-3858-17 17 cm/6¾"



Bohler
 15 cm/6"



McIndoe
 12-3861-17
 17.5 cm/7"

Bone Rongeur Forceps ● EN
 Hohlmeißelzangen ● DE
 Pinzas-gubias ● ES

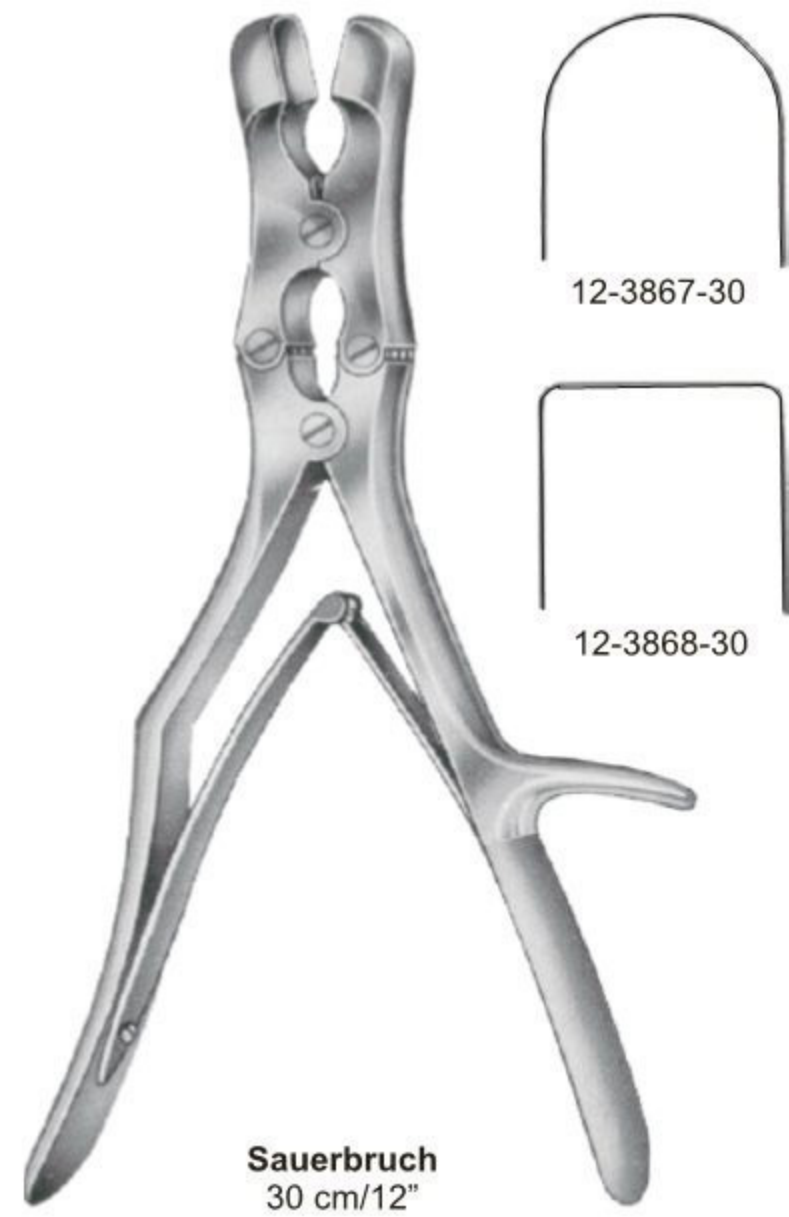

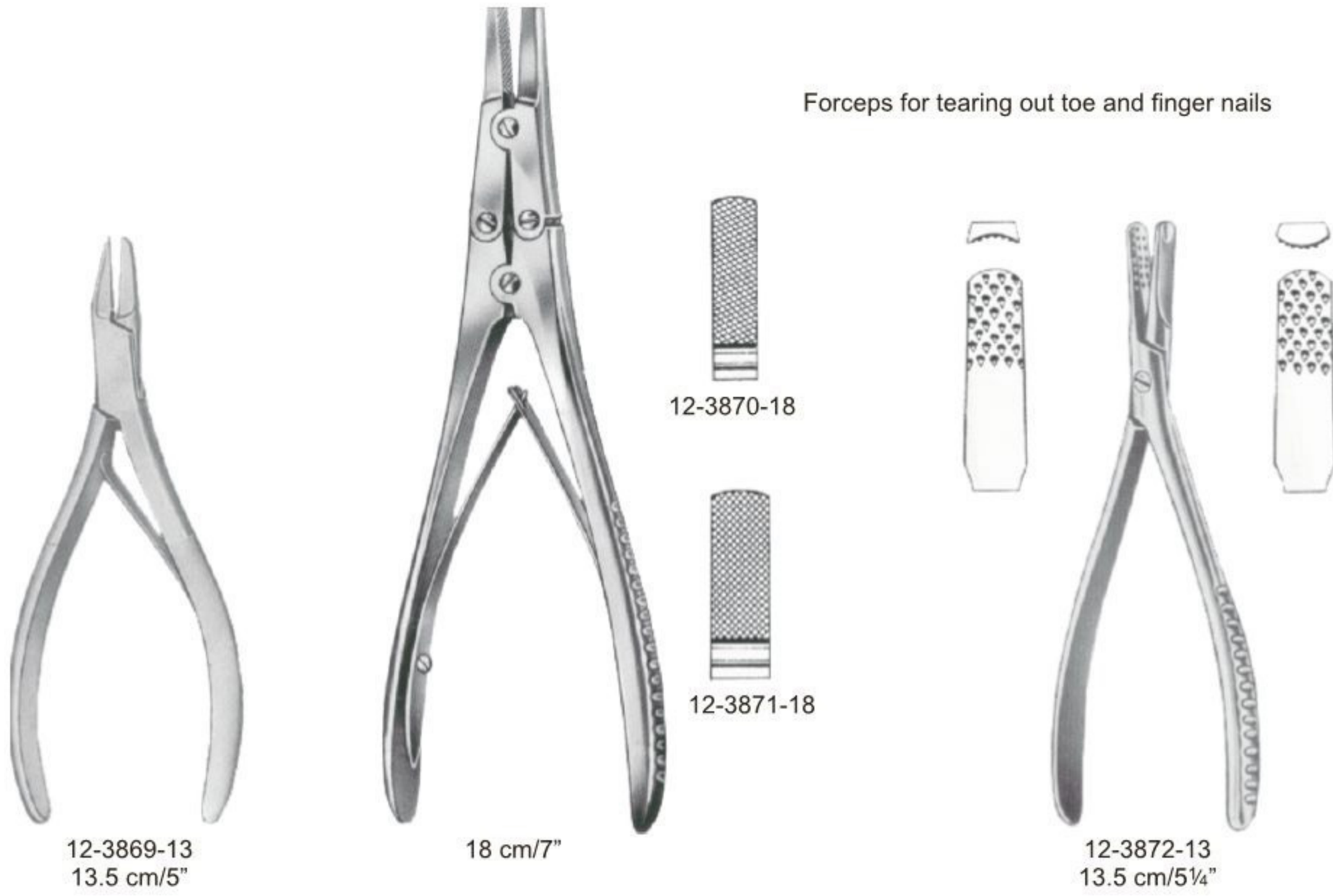

Saw blade



12-3873-17
17 cm/6 3/4"



12-3874-17
17 cm/6 3/4"

Saw blade



Kazanjian
 12-3875-18
 18 cm/7"



Ruskin-Liston
 18.5 cm/7 1/4"



Stille-Liston
 23 cm/9"
 27 cm/10 1/2"

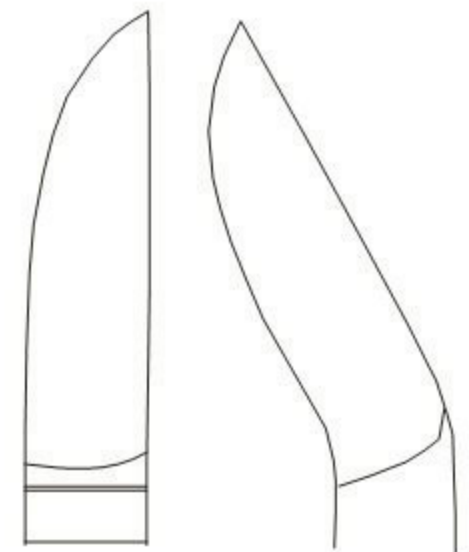
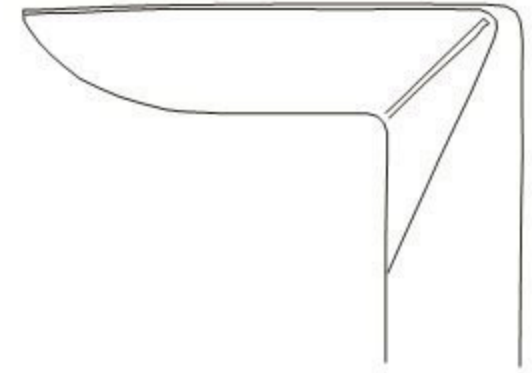

Liston-Key(Horsley)
 12-3881-27
 27 cm/10 1/2"



Semb
 12-3882-24
 24 cm/9 1/2"



12-3883-13 13 cm/5"
 12-3883-18 18 cm/7"



12-3884-17
 17 cm/6¾"

TC

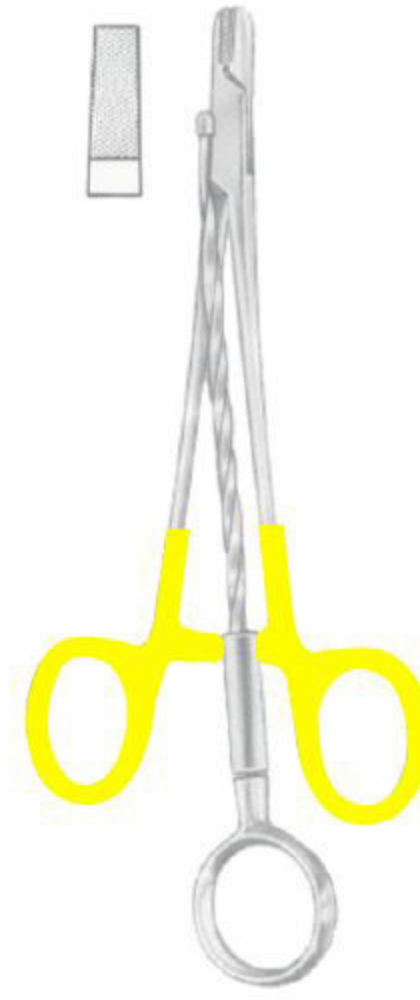

12-3885-15
 15.5 cm/6"



12-3886-17 17 cm/6¾" 12-3887-17



12-3888-19
 19 cm/7½"

Wire Seizing Forceps ● EN
 Faßzangen ● DE
 Pinzas para coger ● ES



12-3889-14
 14 cm/5½"



12-3890-16
 16 cm/6¼"



18cm/7"



12-3891-01



12-3891-02



12-3891-03



12-3891-04



12-3891-05

TC



12-3892-18 18 cm/7"
 12-3892-20 20 cm/8"

TC



12-3893-16
 15 cm/6"

12-3893-20
 20 cm/8"

12-3894-16
 15 cm/6"



For soft wire
 with a diam. of max.

12-3895-15
 15 cm/6"
 2.0 mm

12-3896-18
 18.5 cm/7¼"
 1.7 mm

12-3897-16
 16 cm/6¼"
 2.0 mm

For hard wire
 with a diam. of max.

1.5 mm

1.7 mm

2.0 mm

Wire Cutting Pliers ● EN
 Draht-Kneifzangen ● DE
 Alicates para cortar alambre ● ES

TC



12-3898-12
 0.7 mm
 0.5 mm
 12 cm/4¾"



12-3899-15
 2.0 mm
 1.0 mm
 15 cm/6"



12-3900-18
 2.0 mm
 1.7 mm
 18 cm/7"



212-3901-18
 2.5 mm
 1.5 mm
 18.5 cm/7¼"



12-3902-18
 2.0 mm
 1.7 mm
 18 cm/7"



12-3903-22
 3.0 mm
 2.5 mm
 22 cm/8¾"



12-3904-22
 3.0 mm
 22 cm/8¾"

Screw Nut Wrench



12-3905-10
 10 cm/4"

Screw Driver



12-3906-12
 12 cm/4 3/4"

Wire Strainer



12-3907-20
 20 cm/8"

Fixation Discs For Drill Wires



12-3908-30
 Pair



12-3909-40



12-3910-42

Fixation Discs



12-3911-51
 Pair

Extension Bows ●— EN
 Extensionsbügel ●— DE
 Estribos para extensión ●— ES



With 1 Pin

Bohler

cm	in	
h x b	h x b	For Arm
16 x 9	6¼ x 3½	12-3912-16

cm	in	
h x b	h x b	For Thigh and Knee
21 x 11	8¼ x 4½	12-3913-21



With 3 Traction Hooks

Kirschner

Clear Width	cm	in
12-3914-01	9.5x7	3¾x2¾
12-3914-02	10.5x10.5	4¼x4¼
12-3914-03	12x12	4¾x4¾
12-3914-04	15.5x15.5	6x6
12-3914-05	20x15.5	8x6



Clear Width

	cm	in
12-3915-18	18x10	07x04
12-3915-27	27x16	10½x06¼



With 3 Traction Hooks

Kirschner

- 12-3916-01 Small Pattern
- 12-3916-02 Medium Pattern
- 12-3916-03 Large Pattern



12-3917-34
 34cm/13½"



Spare Screw

Tendon Passing Instruments

Malleable



Bunnell
 12-3918-18 18cm/7"
 12-3918-23 23cm/9"

Tendon Strippers



Bunnell
 23cm/9"

mm Ø
 4.0 12-3919-40
 4.5 12-3919-45
 5.5 12-3919-55
 Flexible Shaft



Fischer
 12-3920-31
 31 cm/12¼"



Brand



12-3921-50
 50 cm/19½"
 06 mm Ø



12-3922-30
 30 cm/12"
 03 mm Ø



Brand
 12-3923-50
 50 cm/19½"

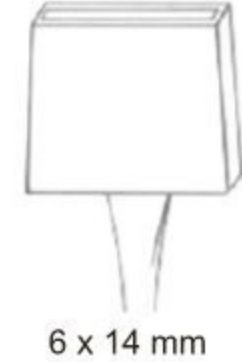

6 x 14 mm

Bone Wire Guides



Bone Wire Tighteners

Loute
 12-3924-00
 21 cm/8¼"



Demel

Bone Wire Guides
 Fig. 1 12-3925-01
 Fig. 2 12-3925-02
 Fig. 3 12-3925-03

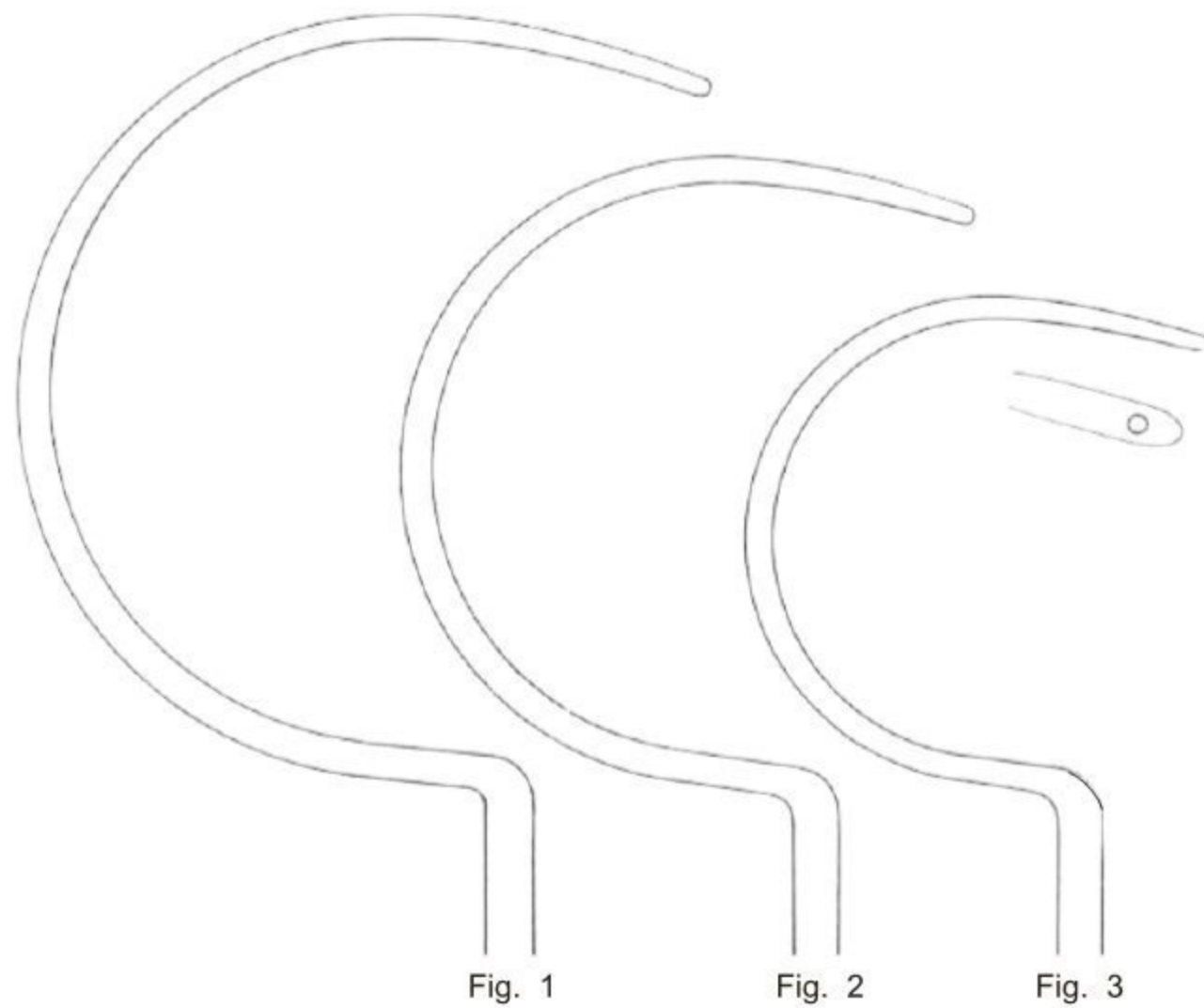

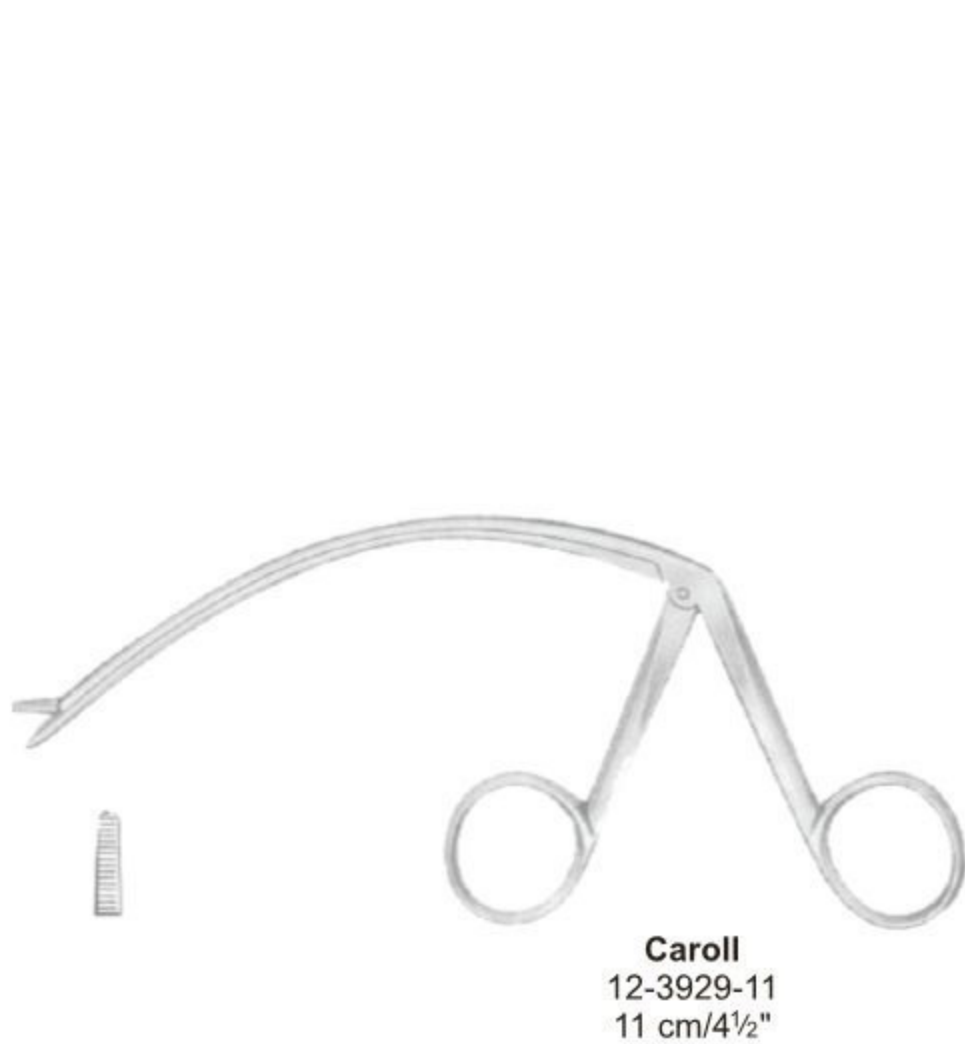
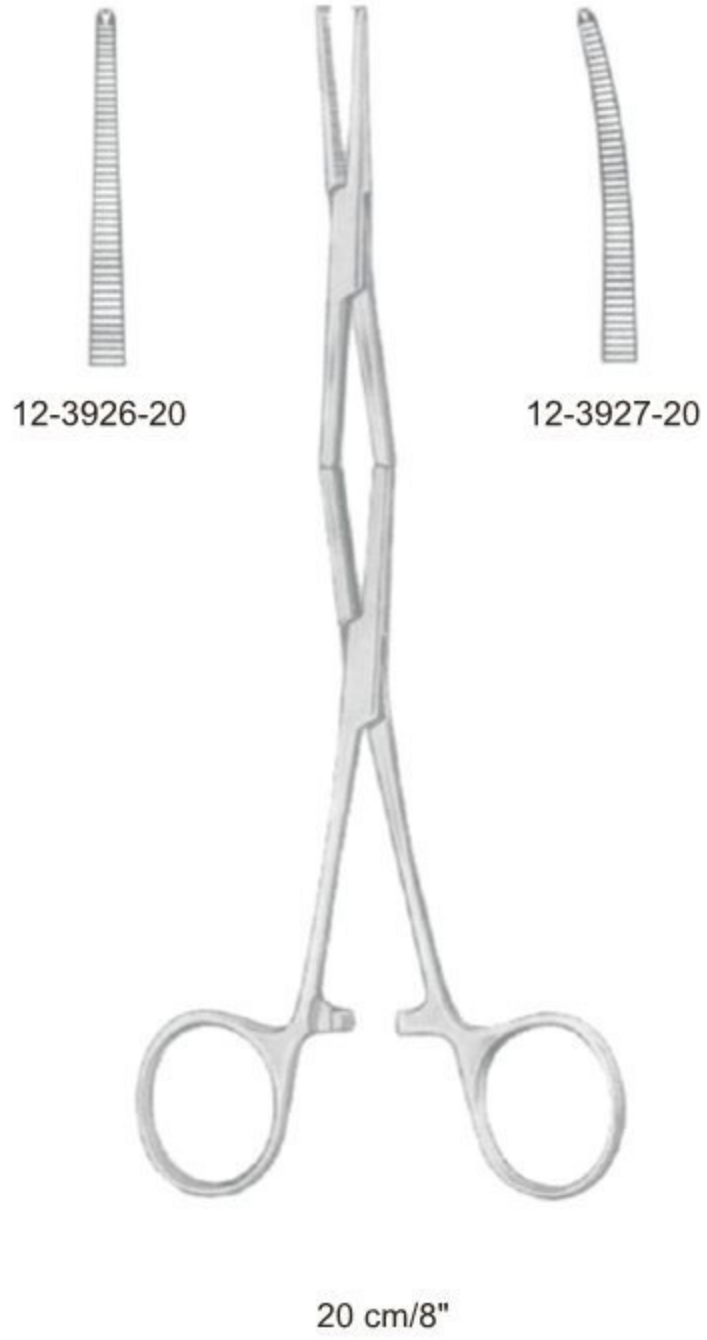

Tendon Seizing Instruments ● EN
 Sehnenfaßinstrumente ● DE
 Instrumentos para coger tendones ● ES



Steinmann
 12-3932-16
 16 cm/6¼"



12-3933-02
 2 mm

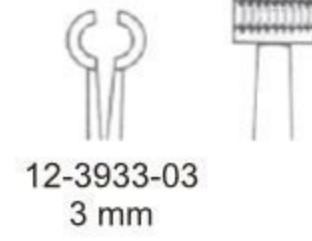

12-3933-03
 3 mm



12-3933-04
 4 mm

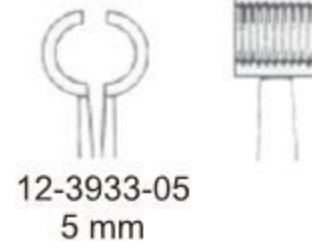

12-3933-05
 5 mm

Larsen
 10 cm/4"



Kleinert-Kutz
 12-3934-20
 20 cm/8"



Brand
 12-3935-15 15 cm/6"
 12-3935-19 19 cm/7½"
 12-3935-24 24 cm/9½"



Brand
 12-3936-15 15 cm/6"
 12-3936-19 19 cm/7½"
 12-3936-24 24 cm/9½"