

- EN** Artery Forceps
- DE** Arterienklemmen
- ES** Pinzas hemostáticas

Page 112 to 140





Terrier
 07-2101-10
 10 cm/4"



Pennington
 07-2102-15 15 cm/6"
 07-2102-20 20 cm/8"



Peau
 07-2103-12
 12.5 cm/5"

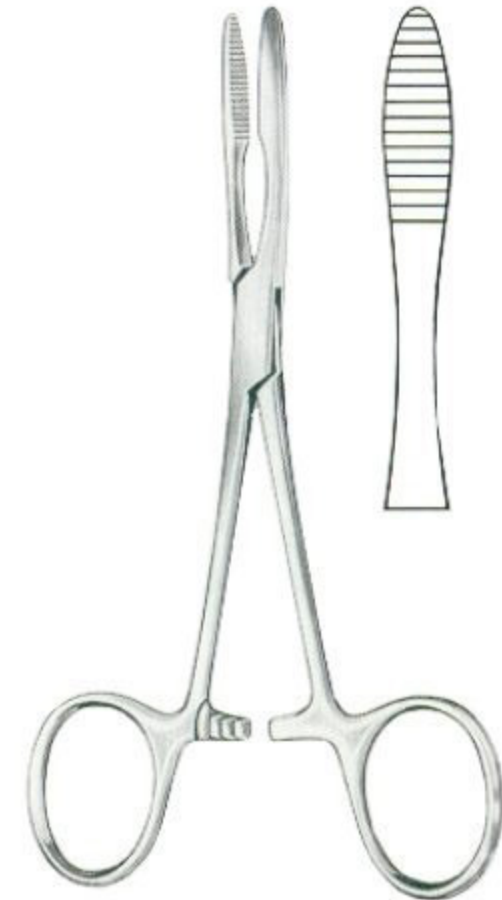

Peau
 07-2104-14 14 cm/5 3/4"
 07-2104-16 16 cm/6 1/4"



Peau
 07-2105-14
 14 cm/5 1/2"



Collin
 07-2106-15
 15.5 cm/6"



Collin
 07-2107-14
 14 cm/5 1/2"



Collin
 07-2108-16
 16.5 cm/6 1/2"



Hartmann
 10 cm/4"

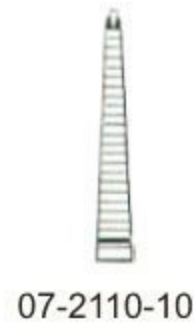

Halstead-Mosquito
 12 cm/4¾"
 14 cm/5½"

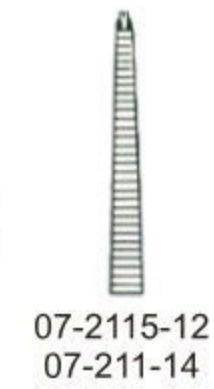

Micro-Mosquito
 10 cm/4"
 12 cm/4¾"

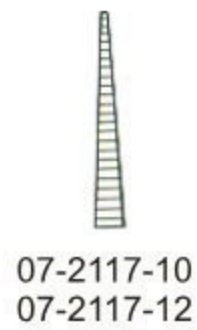

Jacobson-Halstead
 13 cm/5"

Very fine



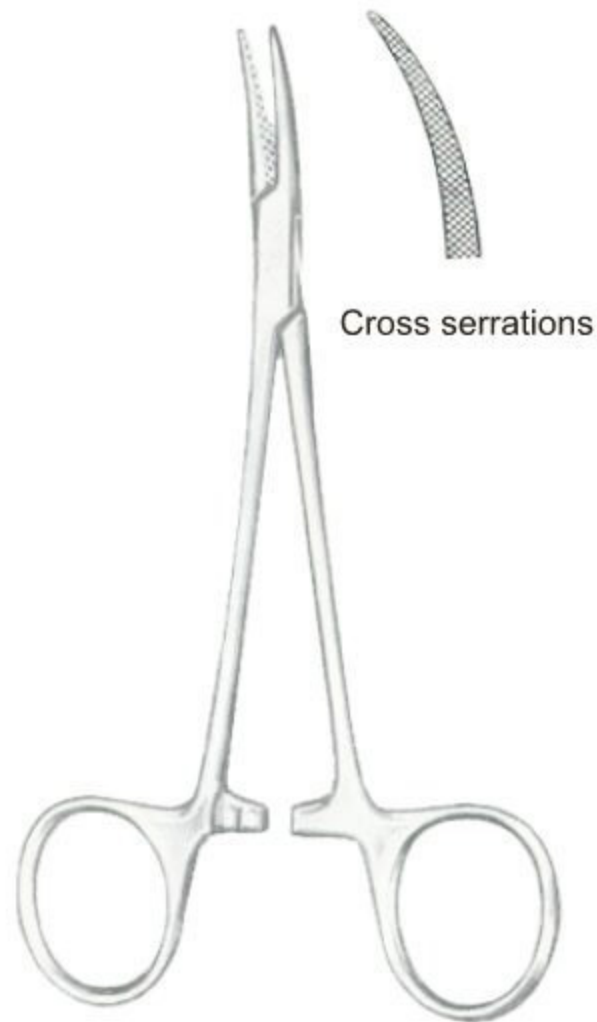

Cross serrations

07-2123-12
 12 cm/4¾"



Halstead-Mosquito
 18 cm/7"
 21 cm/8¼"



07-2124-18
 07-2124-21



07-2125-18
 07-2125-21



07-2126-18
 07-2126-21



07-2127-18
 07-2127-21



Kelly
 14 cm/5½"

Kelly-Rankin
 16 cm/6¼"



07-2128-14



14 cm/5½" 07-2129-14



07-2130-16



16 cm/6¼" 07-2131-16



Crile
 14 cm/5½"

Crile-Rankin
 16 cm/6¼"

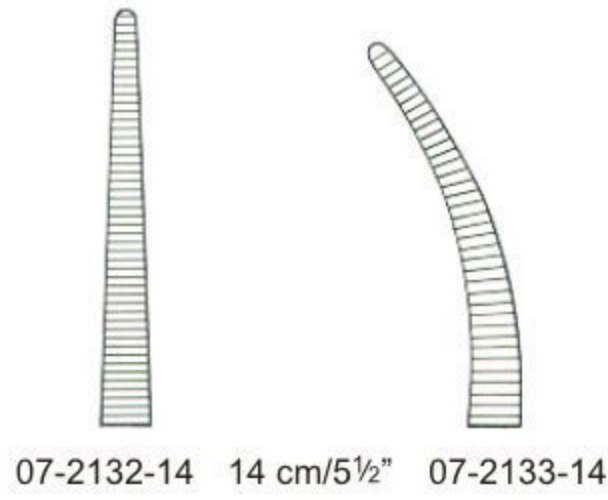

07-2132-14 14 cm/5½" 07-2133-14

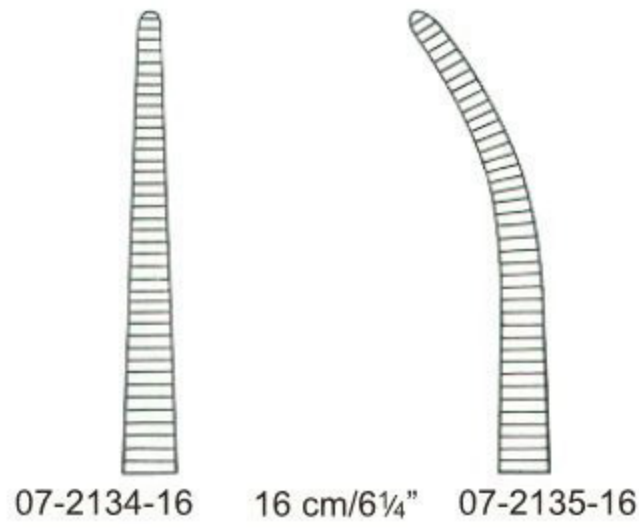

07-2134-16 16 cm/6¼" 07-2135-16



Baby-Crile
 14 cm/5½"

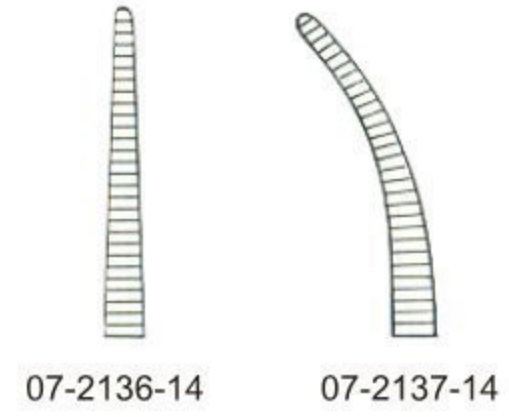

07-2136-14 07-2137-14



Crile
 14 cm/5½"

Crile-Rankin
 16 cm/6¼"

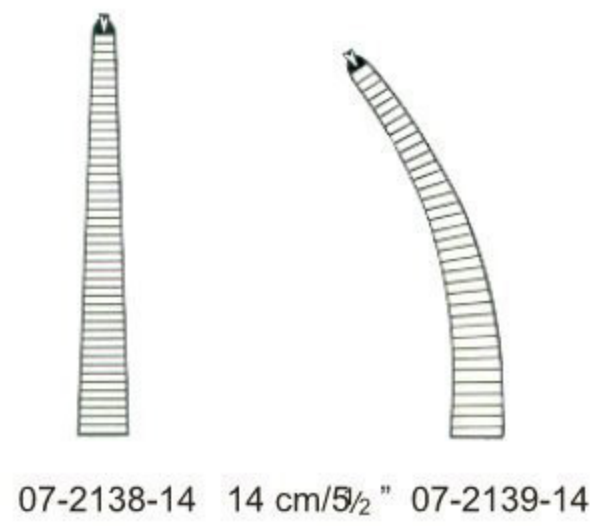

07-2138-14 14 cm/5½" 07-2139-14

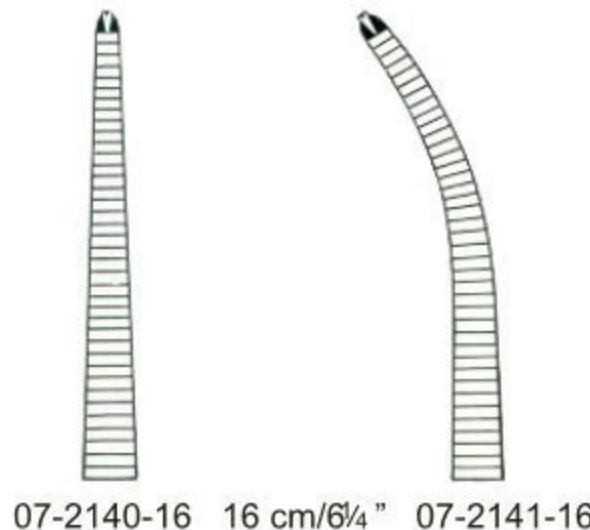

07-2140-16 16 cm/6¼" 07-2141-16



Baby-Crile
 14 cm/5½"

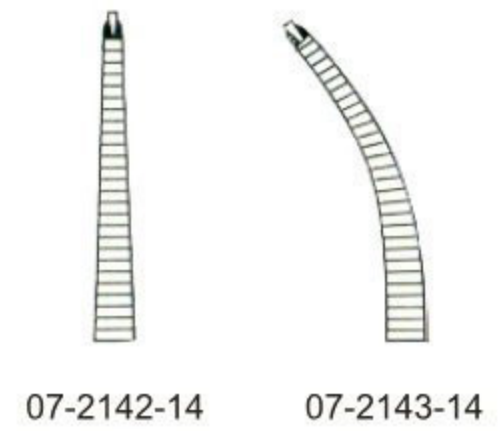

07-2142-14 07-2143-14



Coller-Crile

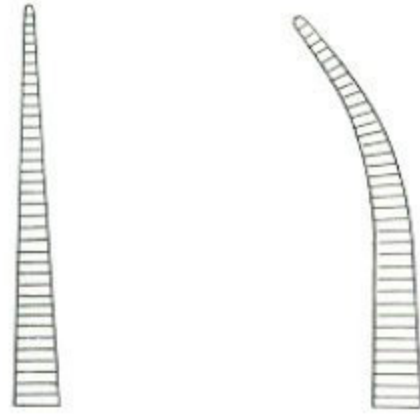

07-2144-14 14 cm/5 1/2" 07-2145-14

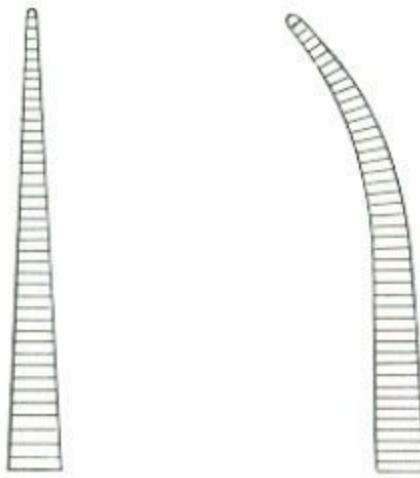

07-2146-16 16 cm/6 1/4" 07-2146-16



Coller-Crile
 07-2147-16
 16 cm/6 1/4"



Leriche
 15 cm/6"

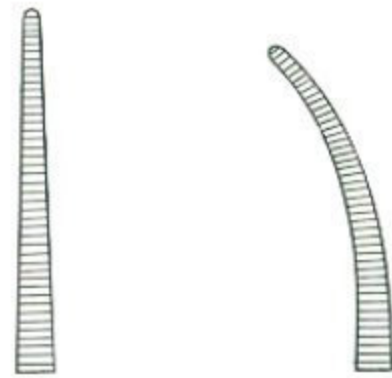

07-2148-15 07-2149-15

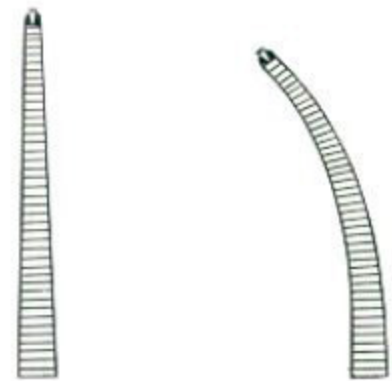

07-2150-15 07-2151-15



Providence
 14 cm/5 1/2"



07-2152-14



07-2153-14

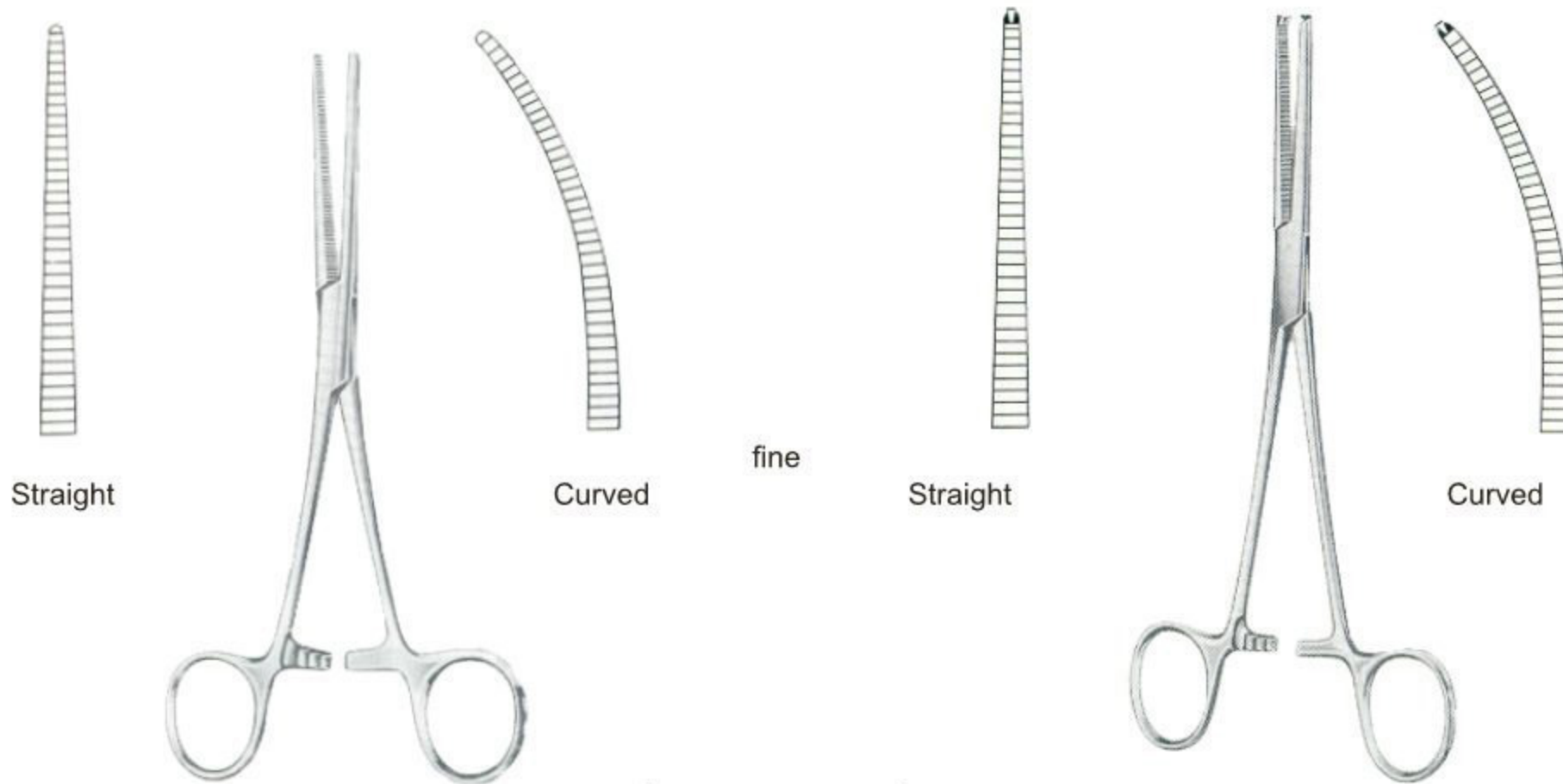

Rochester-Pean		cm	in	Ochsner-Kocher	
07-2154-13	07-2155-13	13.0	5"	07-2156-13	07-2157-13
07-2154-14	07-2155-14	14.0	5 1/2"	07-2156-14	07-2157-14
07-2154-16	07-2155-16	16.0	6 1/4"	07-2156-16	07-2157-16

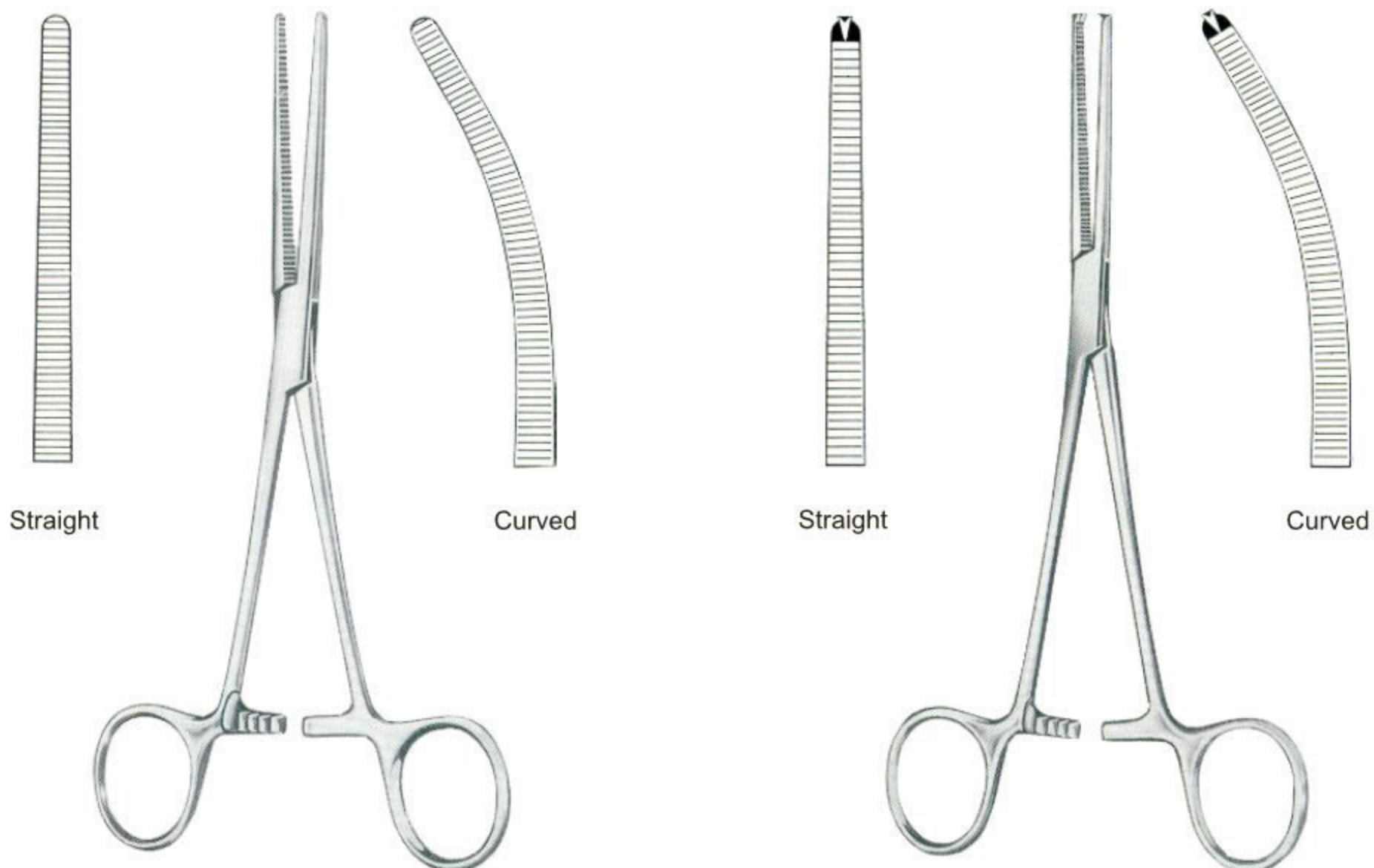

Rochester-Pean		cm	in	Ochsner-Kocher	
07-2158-13	07-2159-13	13.0	5"	07-2160-13	07-2161-13
07-2158-14	07-2159-14	14.0	5 1/2"	07-2160-14	07-2161-14
07-2158-16	07-2159-16	16.0	6 1/4"	07-2160-16	07-2161-16
07-2158-18	07-2159-18	18.0	7"	07-2160-18	07-2161-18
07-2158-20	07-2159-20	20.0	8"	07-2160-20	07-2161-20
07-2158-22	07-2159-22	22.0	8 3/4"	07-2160-22	07-2161-22
07-2158-24	07-2159-24	24.0	9 1/2"	07-2160-24	07-2161-24
07-2158-26	07-2159-26	26.0	10 1/4"	07-2160-26	07-2161-26
07-2158-30	07-2159-30	30.0	12"	07-2160-30	07-2161-30

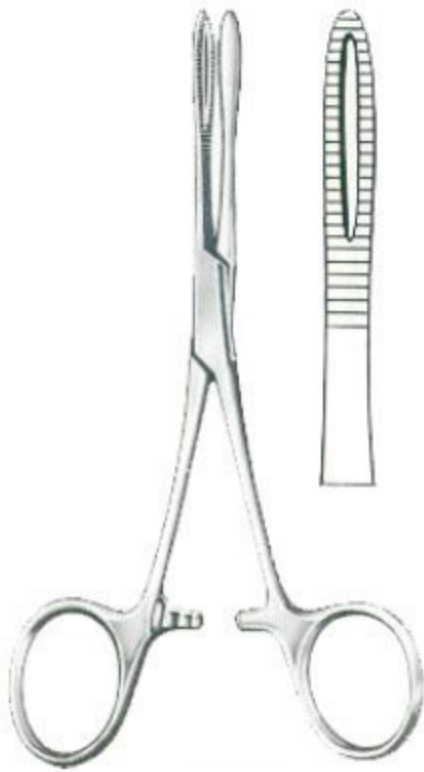
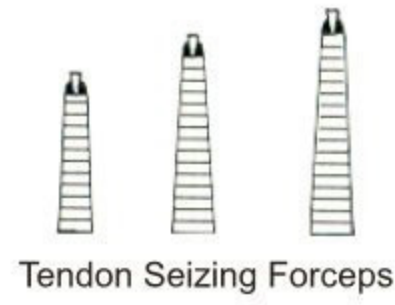

Kronlein
 07-2162-13
 13cm/5"



Brand
 07-2163-15 15cm/6"
 07-2163-19 19cm/7 1/2"
 07-2163-24 24cm/9 1/2"



Brand
 07-2164-15 15cm/6"
 07-2164-19 19cm/7 1/2"
 07-2164-24 24cm/9 1/2"

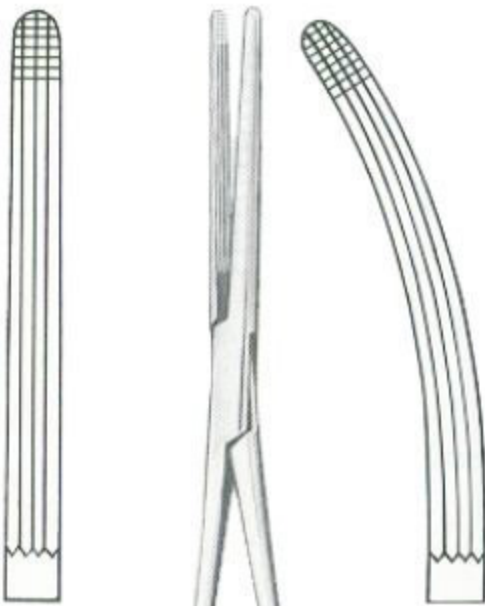

07-2165-16
 07-2165-20

07-2166-16
 07-2166-20



Rochester-Carmalt
 16cm/6 1/4"
 20cm/8"

Lateral Curved



07-2167-12



Mosquito-Dandy
 12cm/4 3/4"



07-2168-12



07-2169-14



Dandy
 14cm/5 1/2"

07-2170-14



Lovelace
 07-2171-15
 15.5cm/6"



Dixon-Lovelace
 07-2172-16
 16cm/6¼"



Dixon-Lovelace
 07-2173-16
 16cm/6¼"



Bainbridge
 15cm/6"
 18cm/7"



Fuchsig
 07-2176-19
 19cm/7½"



Adson
 18.5cm/7¼"

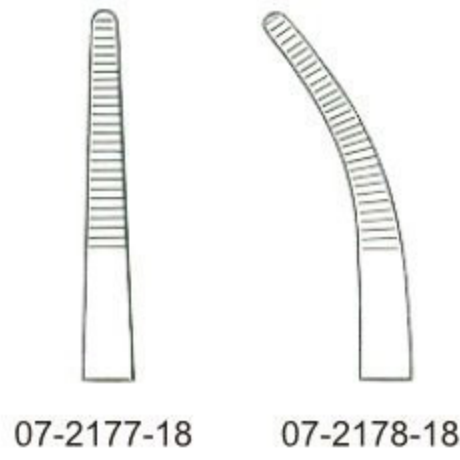

07-2177-18 07-2178-18

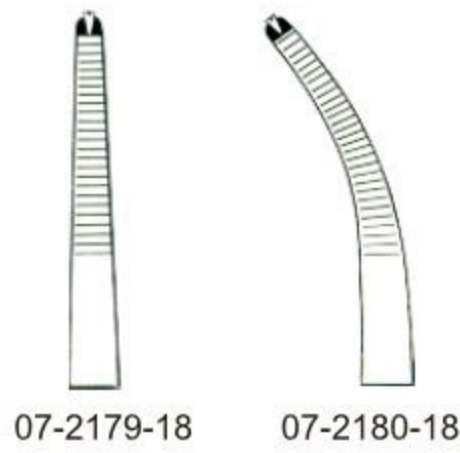

07-2179-18 07-2180-18



Nissen
 07-2181-18 18.5cm/7 ¼"
 07-2181-22 22.0cm/8 ¾"



Baby-Adson



07-2182-14
 14cm/5½"



07-2182-18
 18cm/7"

Very Fine



Jacobson-Adson
 18cm/7"

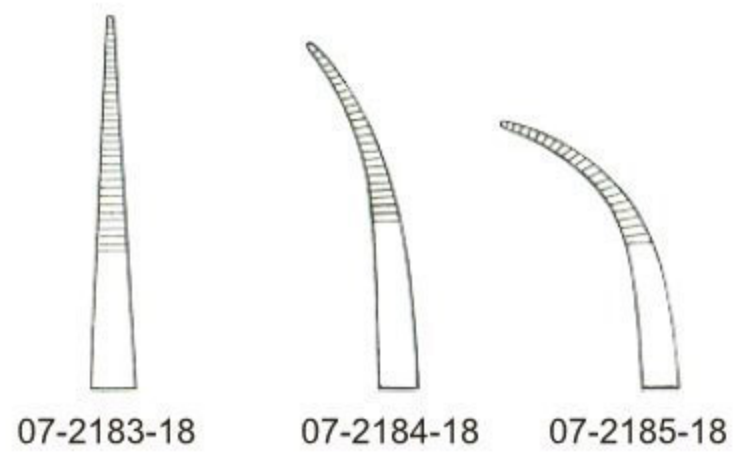

07-2183-18 07-2184-18 07-2185-18

Artery Forceps ● EN
 Arterienklemmen ● DE
 Pinzas hemostaticas ● ES

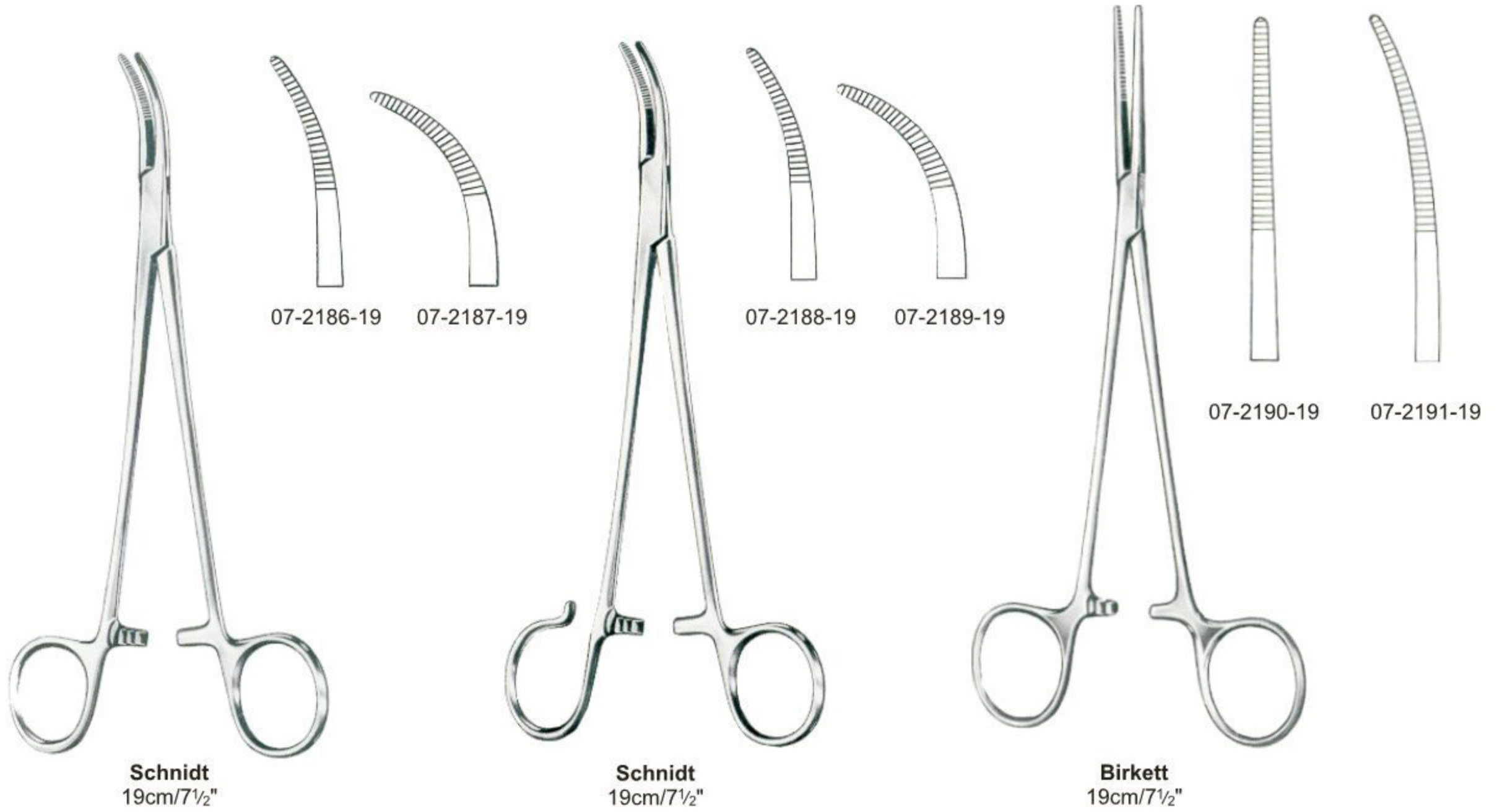

Schnidt
19cm/7½"

Schnidt
19cm/7½"

Birkett
19cm/7½"



Bengolea

20cm/8"	07-2192-20	07-2193-20	07-2194-20	07-2195-20
22cm/8¾"	07-2192-22	07-2193-22	07-2194-22	07-2195-22
24cm/9½"	07-2192-24	07-2193-24	07-2194-24	07-2195-24
26cm/10¼"	07-2192-26	07-2193-26	07-2194-26	07-2195-26



Bridge
 27cm/10½"

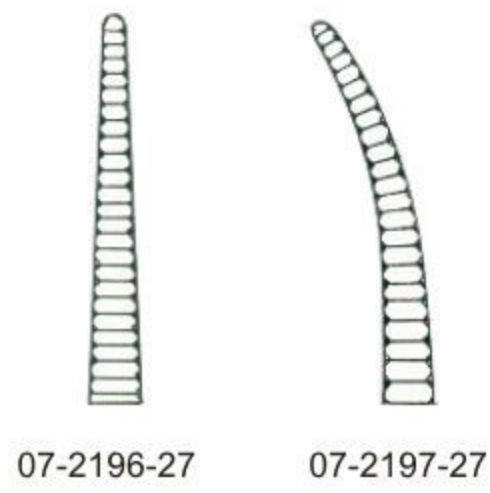

Roberts
 22cm/8¾"

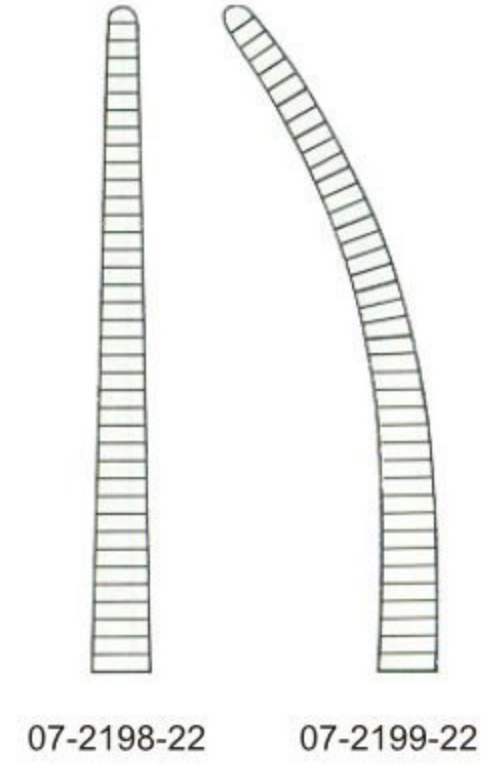

Kelly

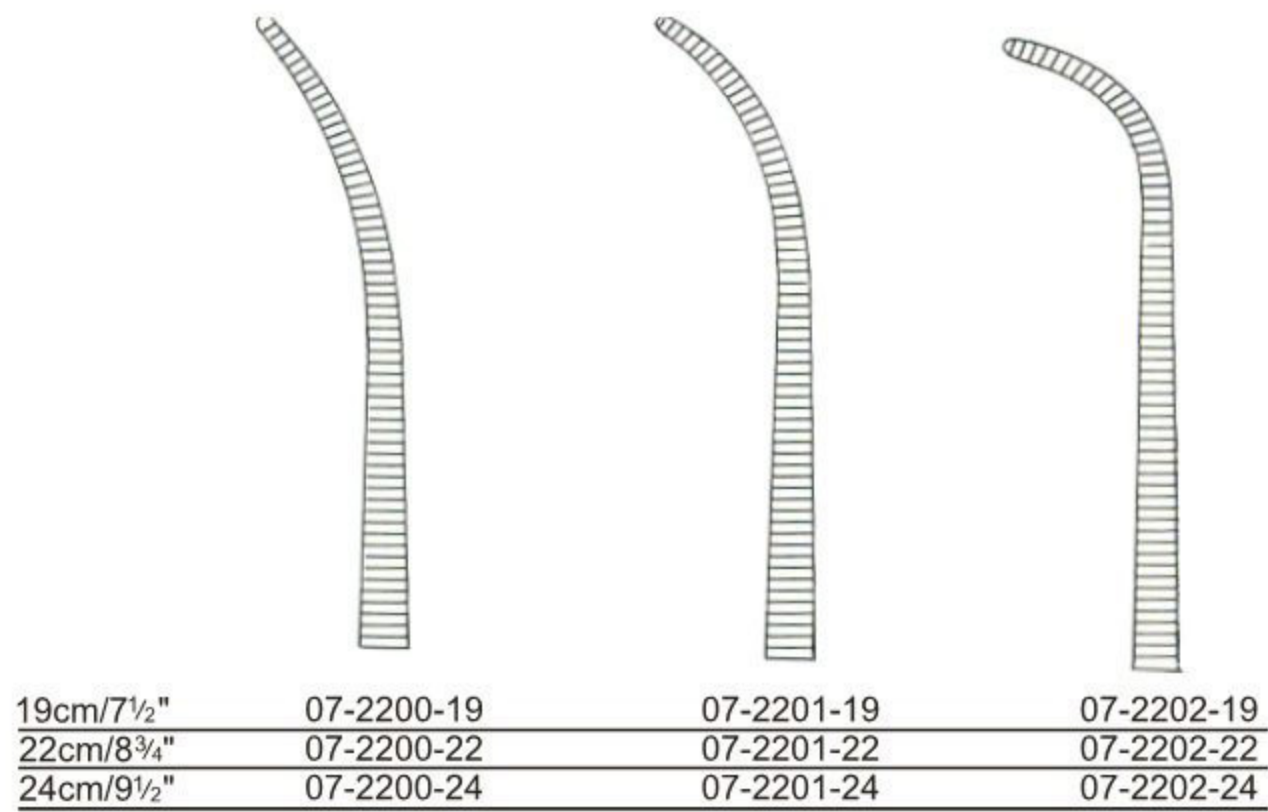

Artery Forceps ● EN
 Arterienklemmen ● DE
 Pinzas hemostaticas ● ES



Crafoord-Sellors

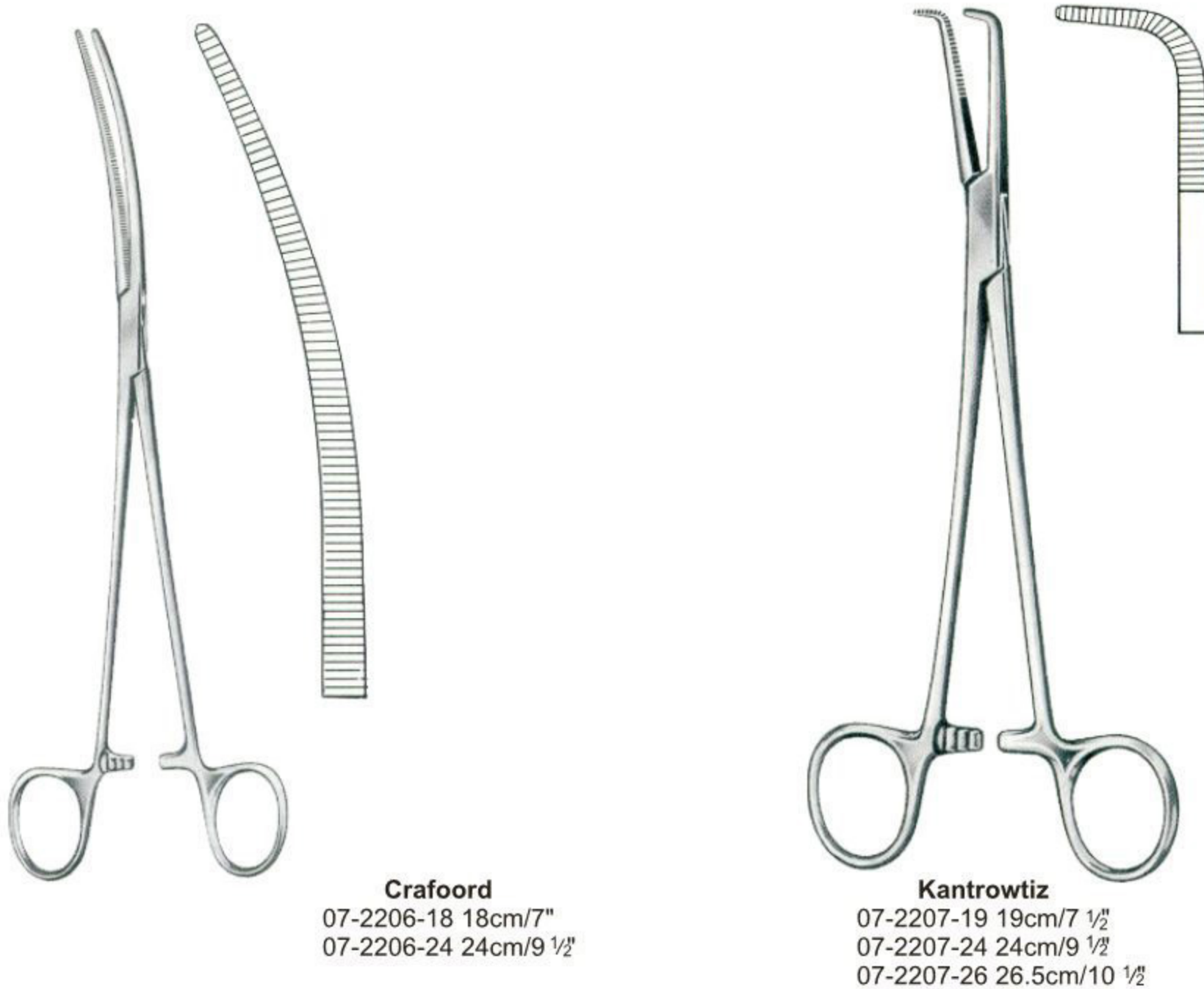



Rumel
 23cm/9"



07-2208-23



07-2209-23



07-2210-23



07-2211-23



07-2212-23



Johns Hopkins
 07-2213-20
 20cm/8"



Zenker
 29.5cm/11½"



07-2214-29



07-2215-29

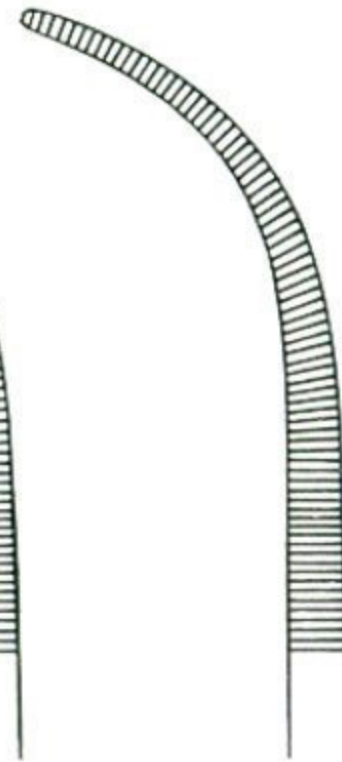

07-2216-29

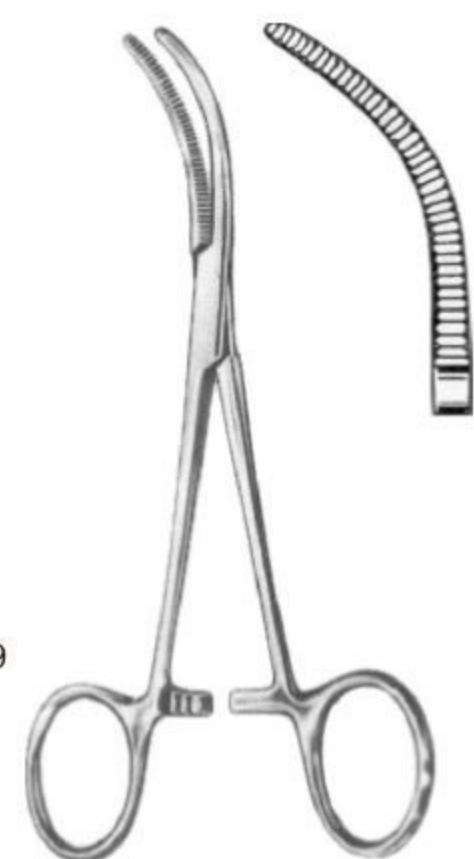

Baby-Overholt
 07-2217-13
 13.5cm/5¼"

Artery Forceps ●— EN
 Arterienklemmen ●— DE
 Pinzas hemostaticas ●— ES

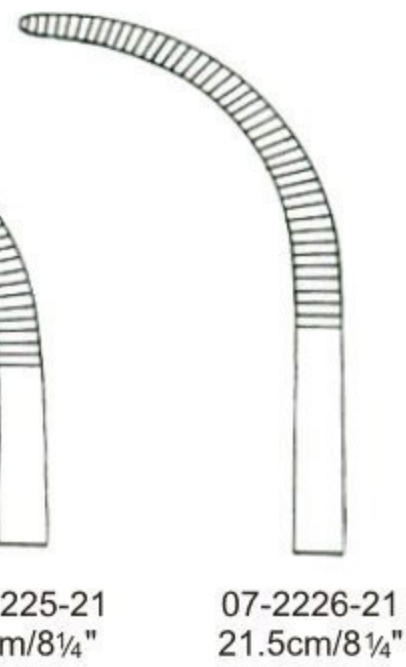
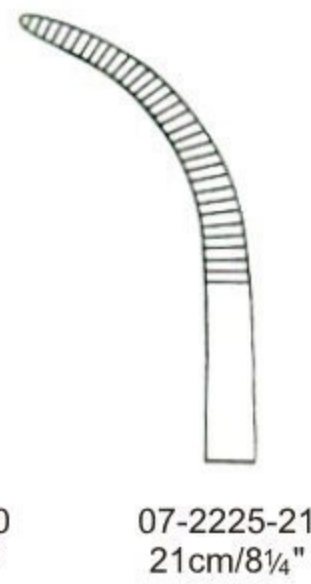
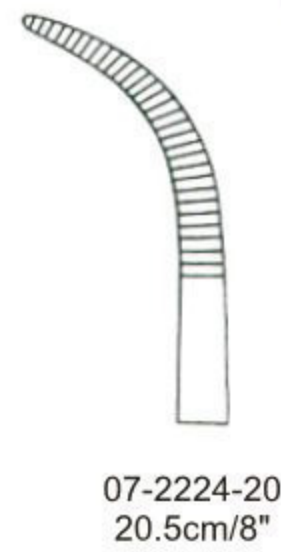
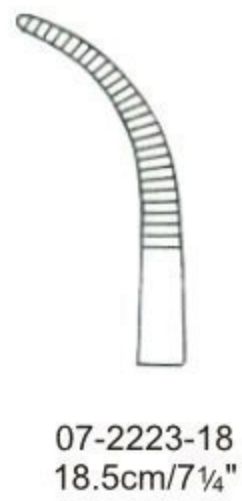
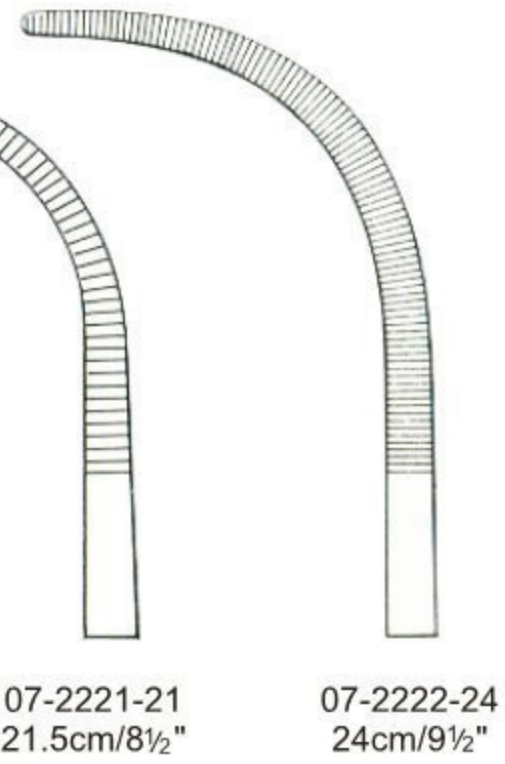
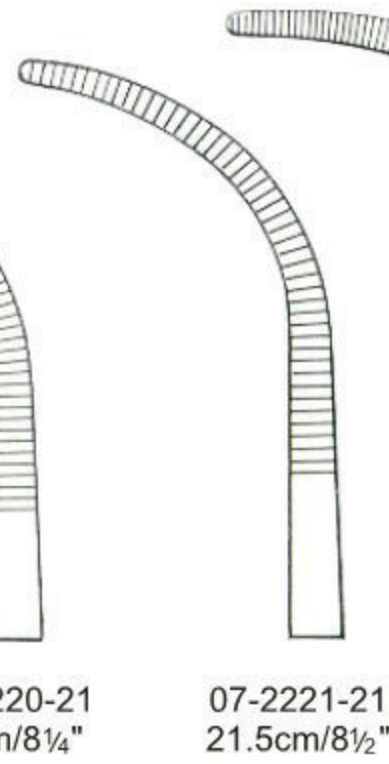
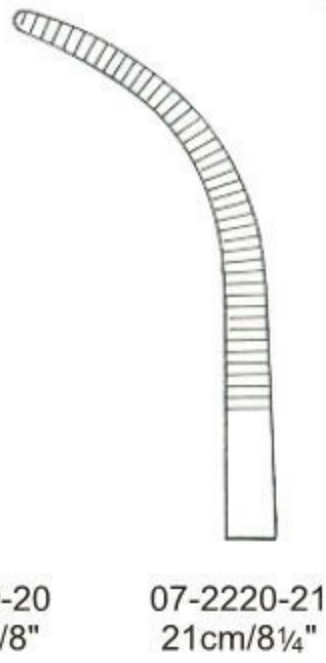
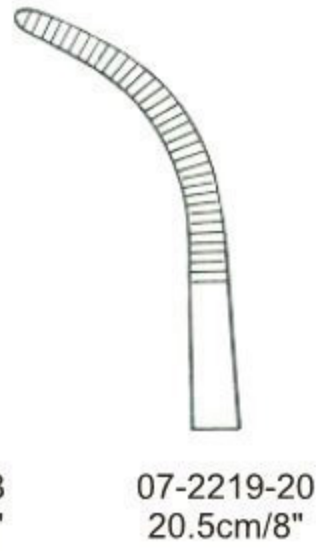
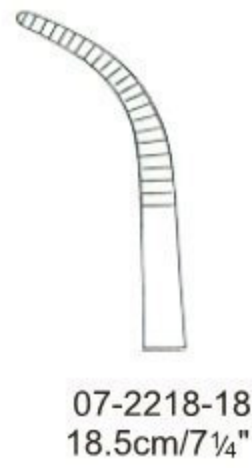



Overholt-Geissendorfer
 21cm/8¼"
 27cm/10½"

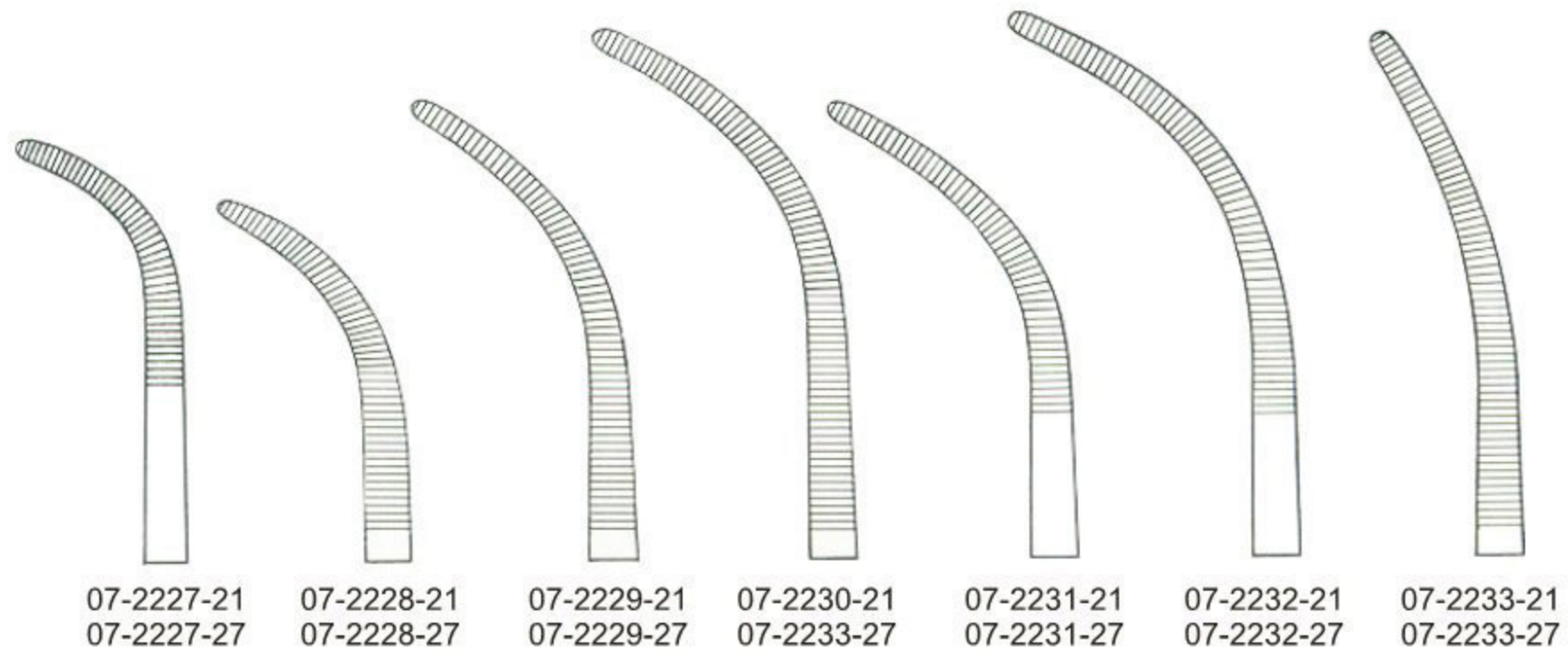

Overholt-Mixter
 07-2234-21
 21cm/8¼"



Heiss
 20cm/8"

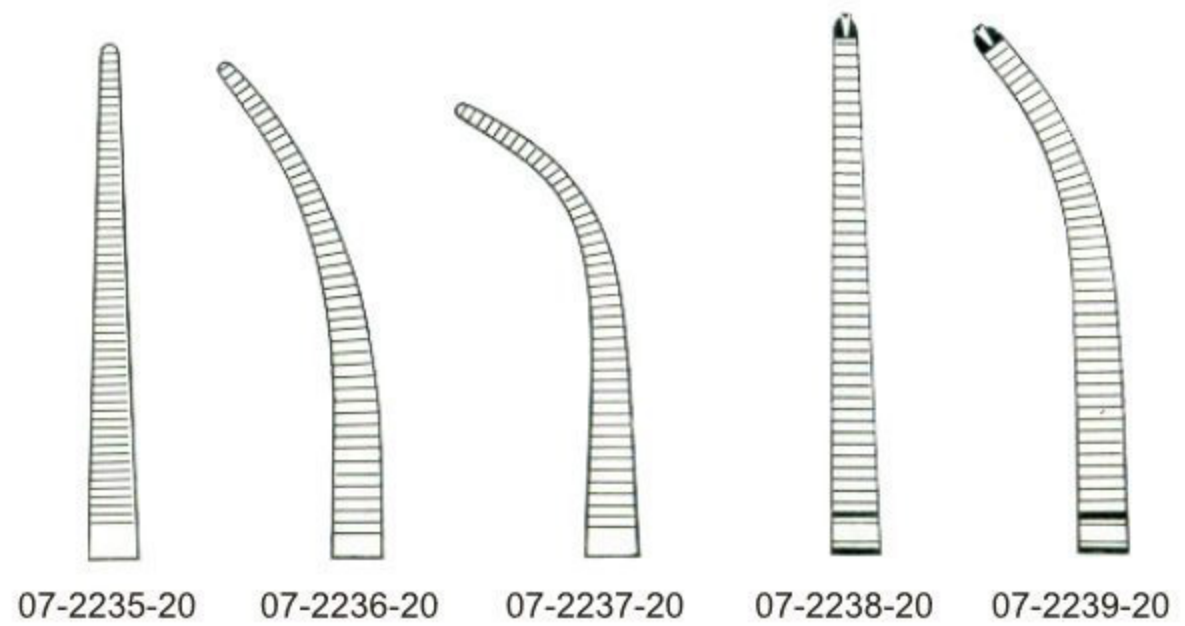



Meeker
 07-2240-27
 27 cm/10½"

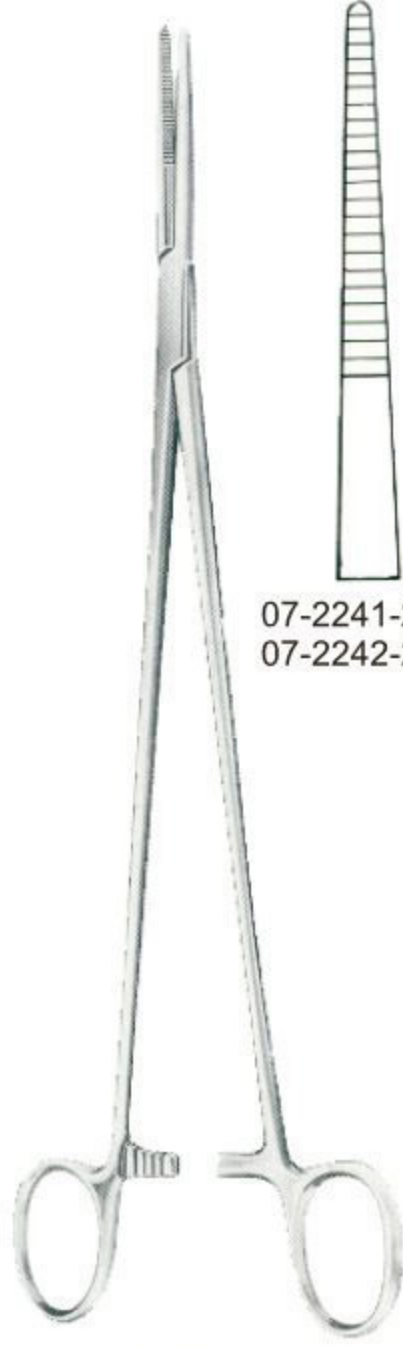

Toennis
 21 cm/8¼"
 26 cm/10¼"

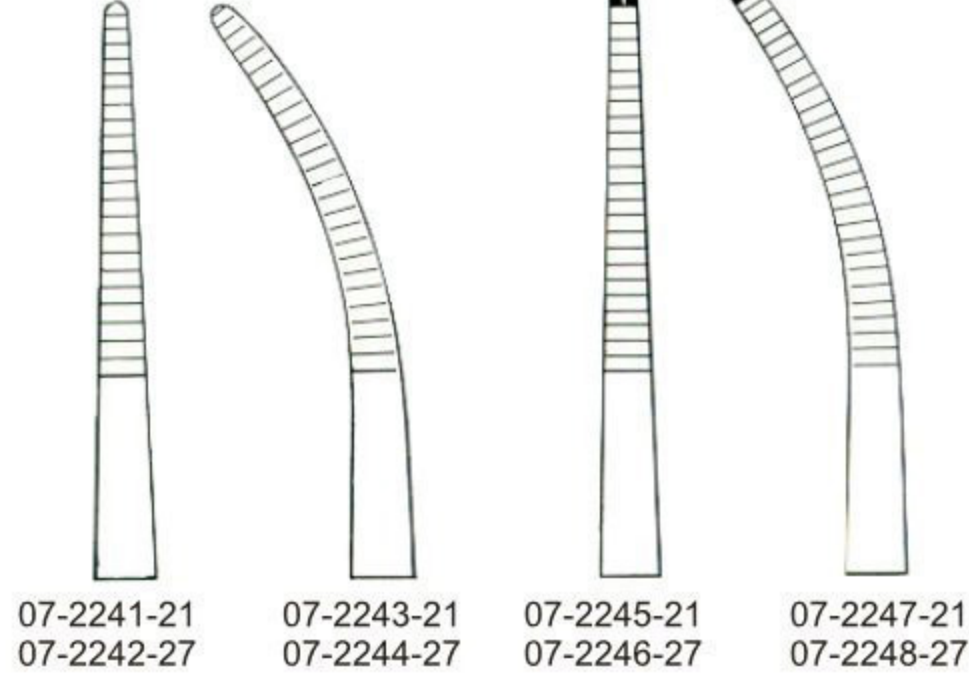

07-2241-21
 07-2242-27

07-2243-21
 07-2244-27

07-2245-21
 07-2246-27

07-2247-21
 07-2248-27



Lower
 07-2249-18
 18 cm/7"



Gemini

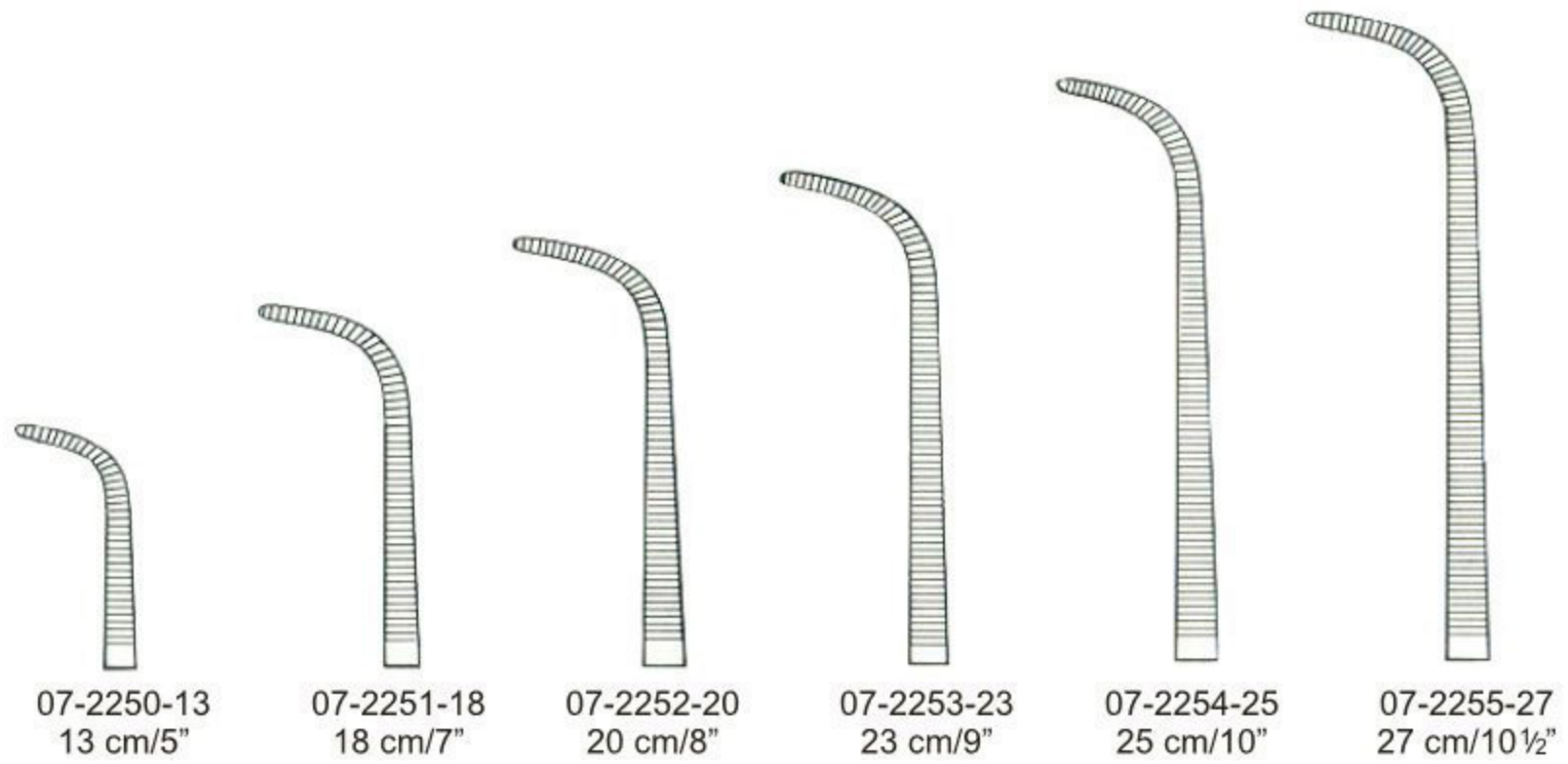

07-2250-13
 13 cm/5"

07-2251-18
 18 cm/7"

07-2252-20
 20 cm/8"

07-2253-23
 23 cm/9"

07-2254-25
 25 cm/10"

07-2255-27
 27 cm/10½"



Mini-Gemini

07-2256-18
 18 cm/7"



07-2256-22
 22 cm/8¾"



07-2256-25
 25 cm/10"



07-2256-28
 28 cm/11"

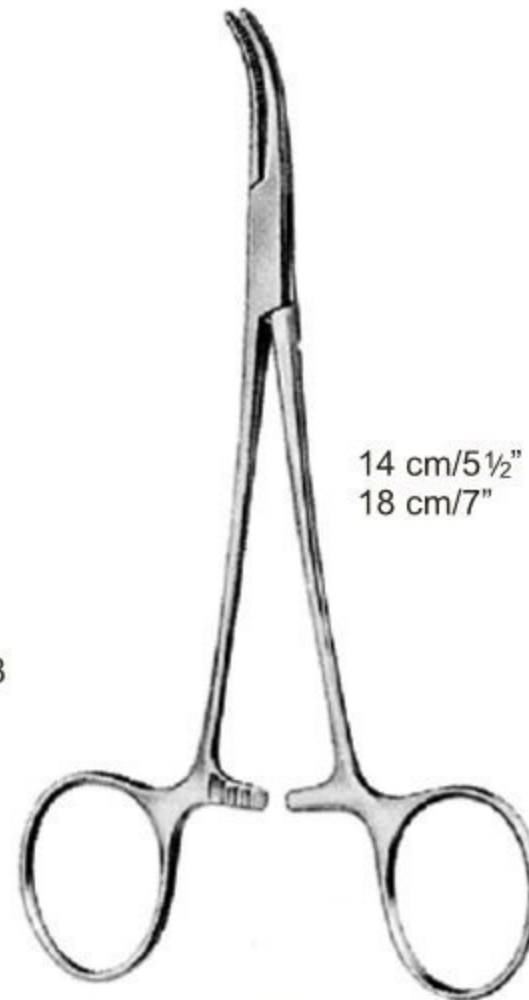

Baby-Mixer

14 cm/5½"
 18 cm/7"



07-2257-14
 07-2257-18



07-2258-14
 07-2258-18



Mixer

07-2259-15 15 cm/6"
 07-2259-19 19 cm/7½"



Mixer-O'Shaugnessy

07-2260-15 15.5 cm/6"
 07-2260-19 19.0 cm/7½"

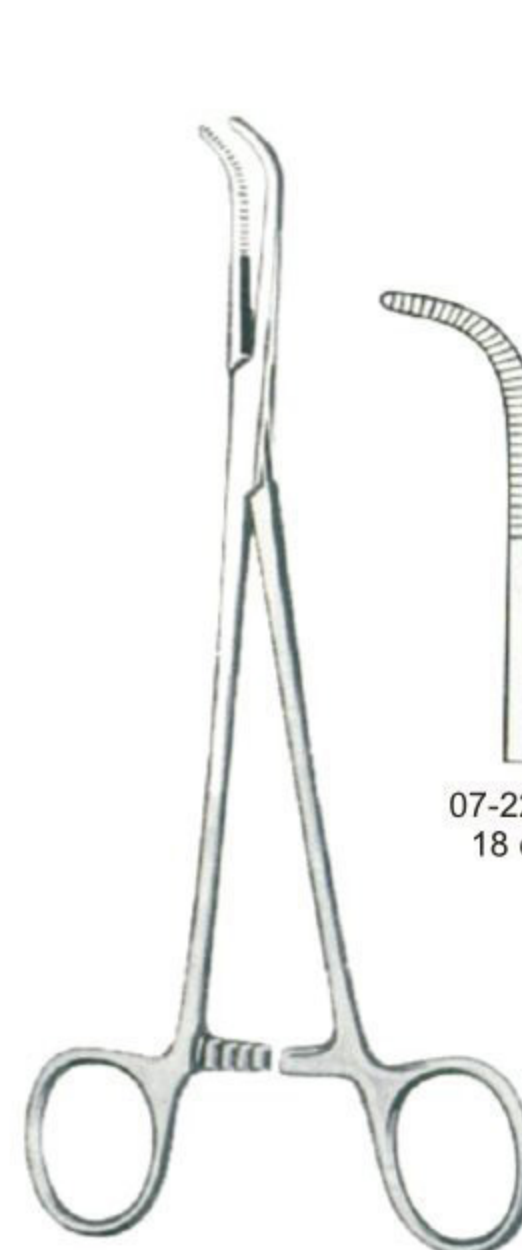

Mixer-Slim

07-2261-18
 18 cm/7"



07-2261-23
 23 cm/9"

Artery Forceps ● EN
 Arterienklemmen ● DE
 Pinzas hemostaticas ● ES



07-2262-22
 22 cm/8¾"

Mixer



07-2262-25
 25 cm/10"

07-2262-28
 28 cm/11"



Mixer
 07-2263-22
 22 cm/8¾"



Wickstroem
 07-2264-20
 20 cm/8"



Finocchietto
 07-2265-24
 24 cm/9½"



Mc Quigg-Mixer
 07-2266-22
 22 cm/8¾"



Lawrence
 07-2267-27
 27.5 cm/10¾"



Lahey (Sweet)

07-2268-19
 19 cm/7½"

07-2269-23
 23 cm/9"

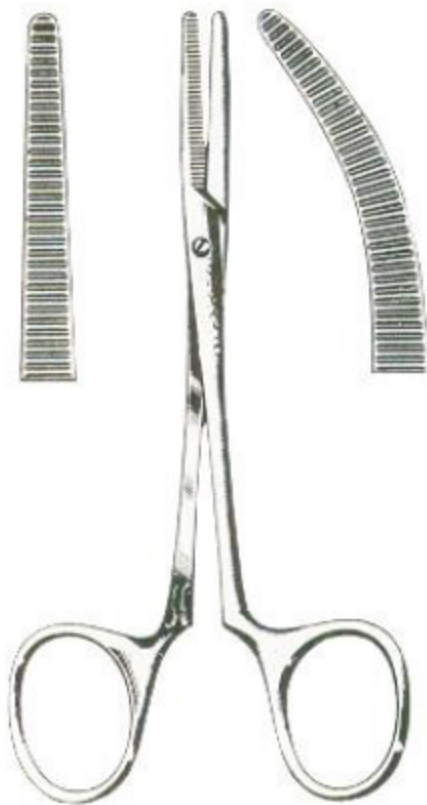

Spencer-Wells

- | | | |
|------------|----------|------------|
| 07-2270-13 | 13 cm/5" | 07-2271-13 |
| 07-2270-15 | 15 cm/6" | 07-2271-15 |
| 07-2270-18 | 18 cm/7" | 07-2271-18 |
| 07-2270-20 | 20 cm/8" | 07-2271-20 |
| 07-2270-23 | 23 cm/9" | 07-2271-23 |



Spencer-Wells

- | | | |
|------------|------------|------------|
| 07-2272-13 | 13 cm/5" | 07-2273-13 |
| 07-2272-14 | 14 cm/5 ½" | 07-2273-14 |
| 07-2272-15 | 15 cm/6" | 07-2273-15 |
| 07-2272-18 | 18 cm/7" | 07-2273-18 |
| 07-2272-20 | 20 cm/8" | 07-2273-20 |
| 07-2272-23 | 23 cm/9" | 07-2273-23 |



Rogers

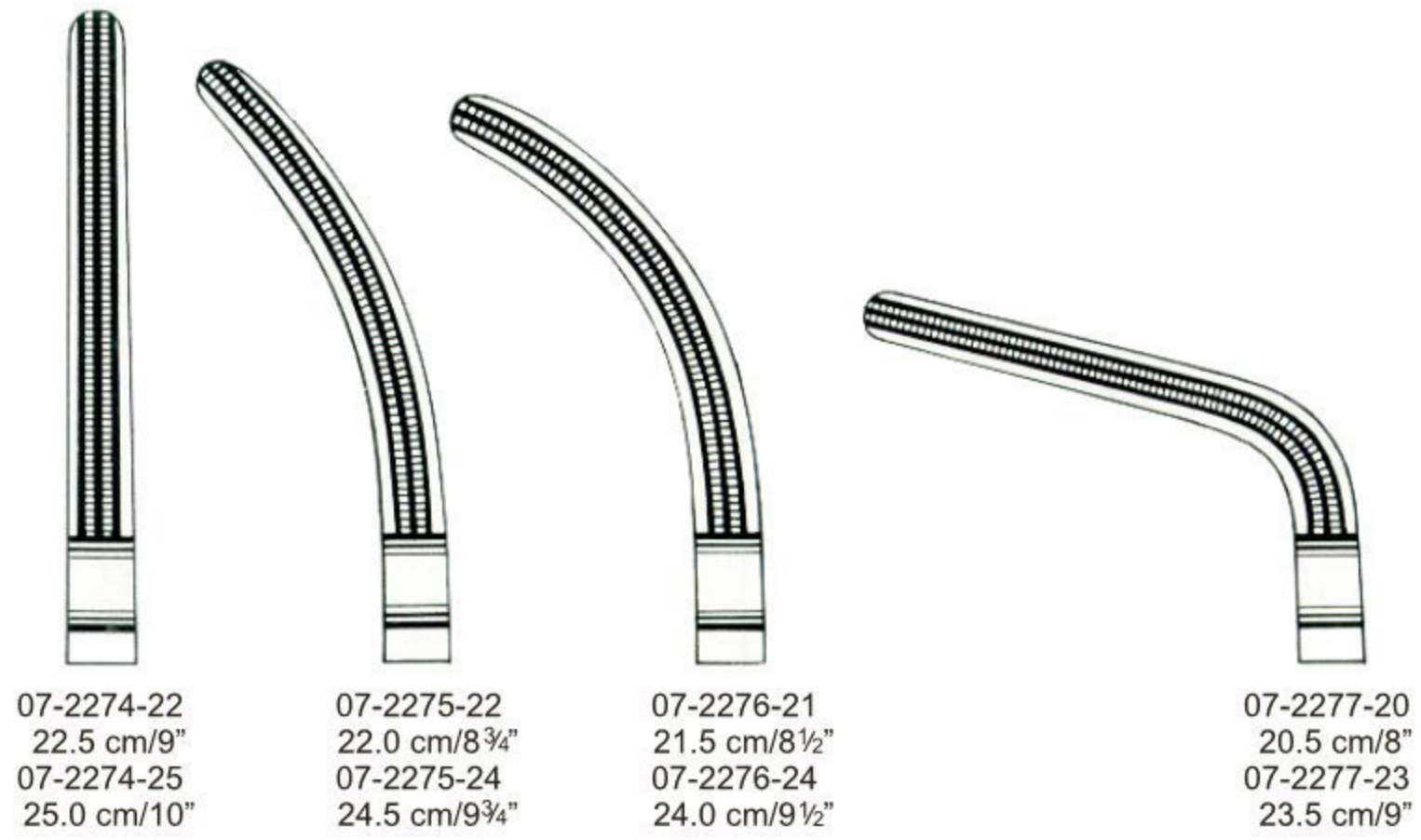

Heaney

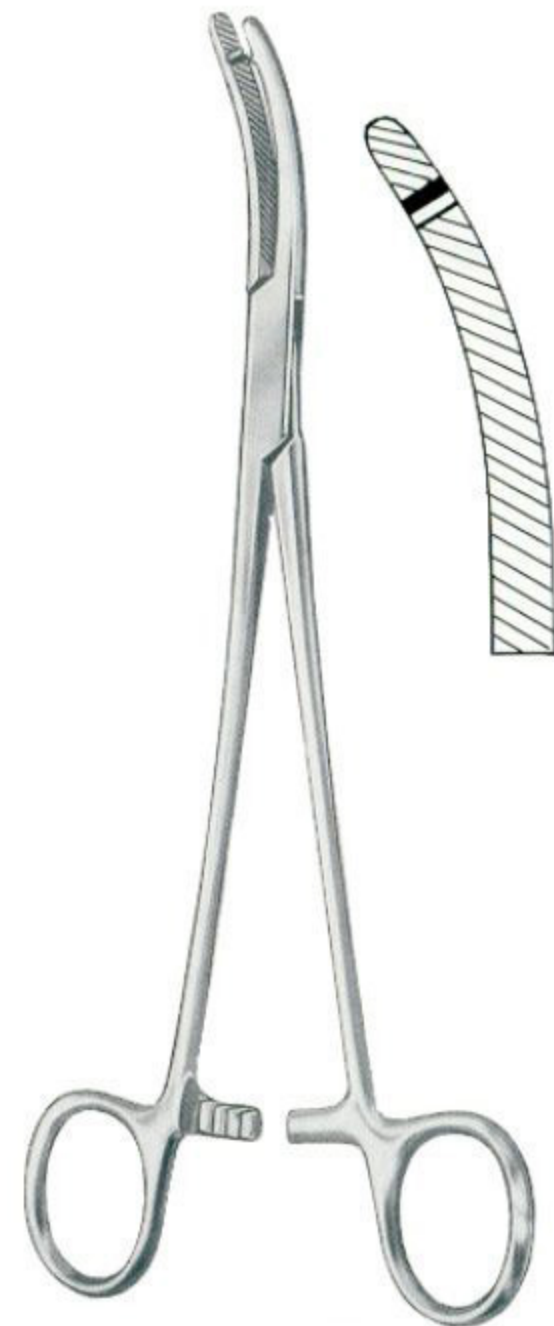
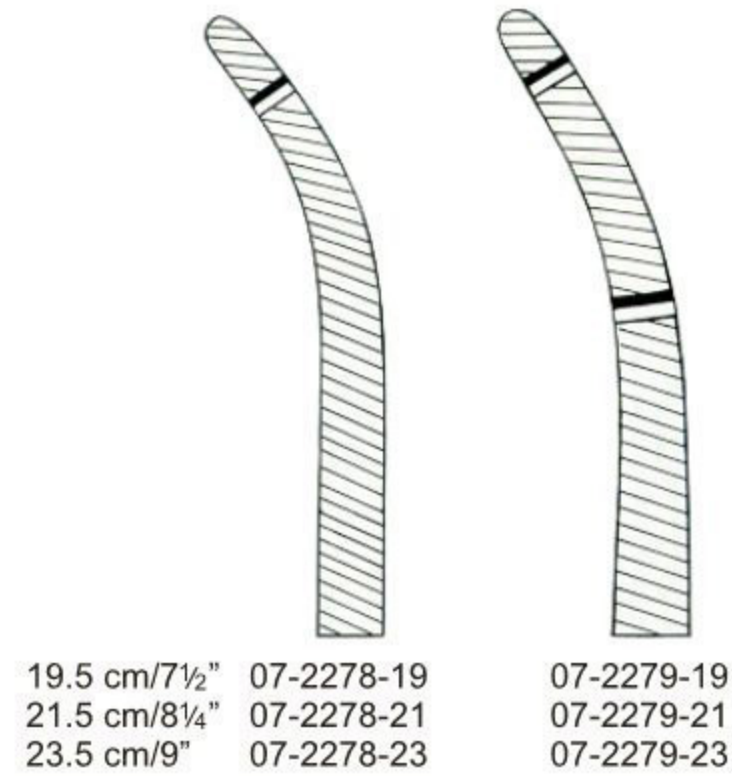

Heaney-Slim
 07-2280-21
 21 cm/8¹/₄"

EN —● Ophthalmologie. Ophthalmology, Oftalmoloia
 DE —● Keratoplastikmesser, Stanzen Meibel
 ES —● Keratoplastikmesser, Stanzen Meibel



Ballentine
 07-2281-21
 21cm/8¼"



Heaney-Ballentine
 07-2282-21
 21cm/8¼"



Tonsil Forceps

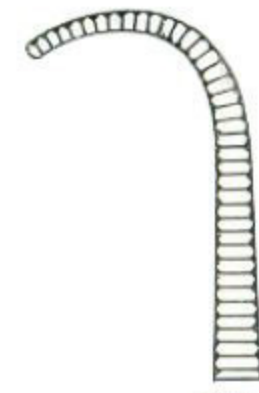

Fig. 1



Fig. 2

Negus
 07-2283-19 19cm/7½" 07-2284-19



Phaneuf
 21.5cm/8½"



07-2285-21



07-2286-21



Haemorrhoidal Clamps

	Straight		Curved
	16cm/6¼"	07-2287-16	07-2288-16
	20cm/8"	07-2287-20	07-2288-20

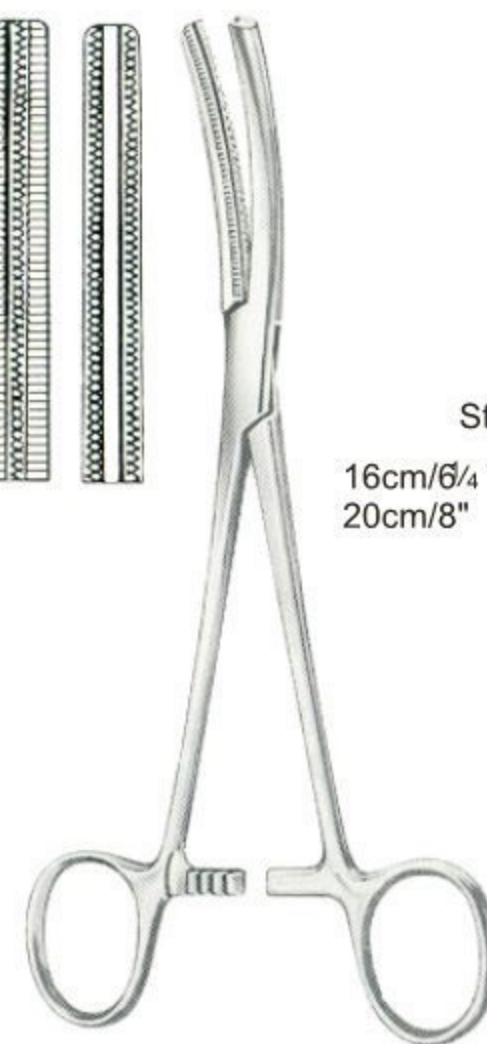

Fergusson

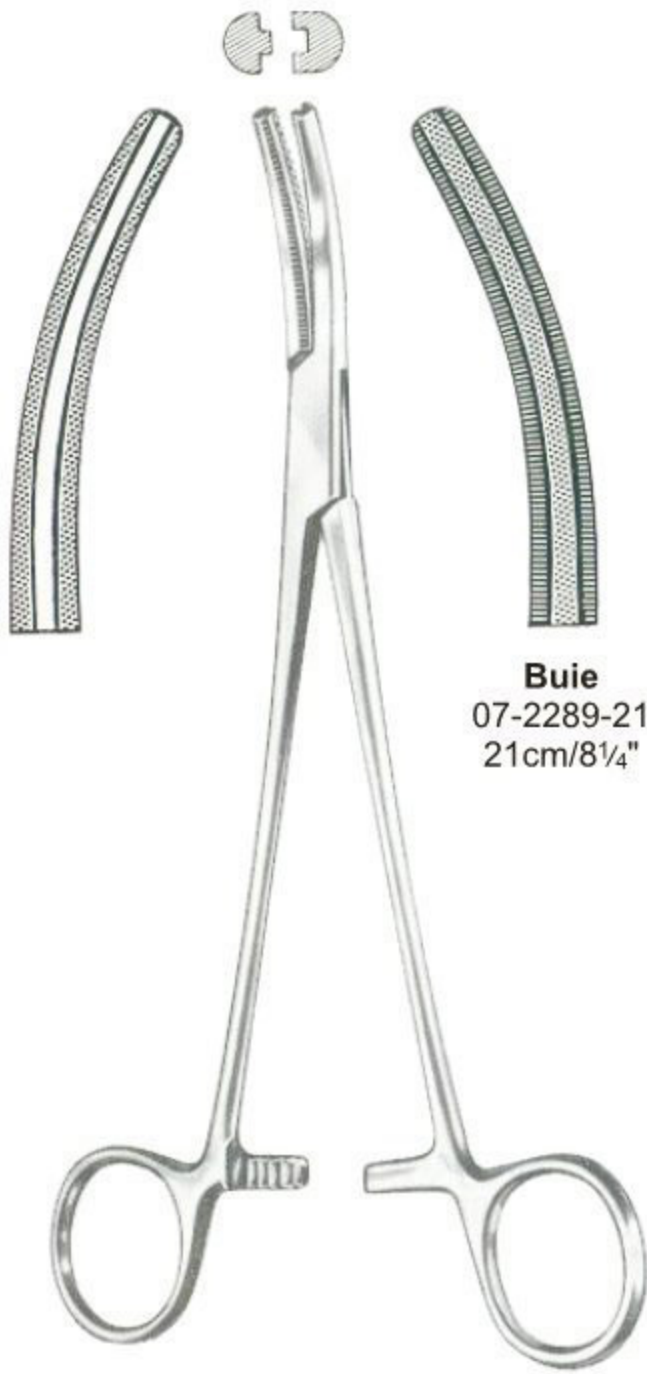

Buie
 07-2289-21
 21cm/8¼"



Long
 07-2290-19
 19cm/7½"



Garland
 07-2291-21
 21cm/8¼"

Gall Duct Clamps

Hysterectomy Forceps

Pressure Clamps



07-2292-23
 23cm/9"

07-2292-24
 24cm/9½"

Moynihan



07-2293-23

07-2294-23

Hozlbach
 23.5cm/9¼"



Zweifel
 07-2295-17
 17.5cm/7"

Scalp Flap Forceps

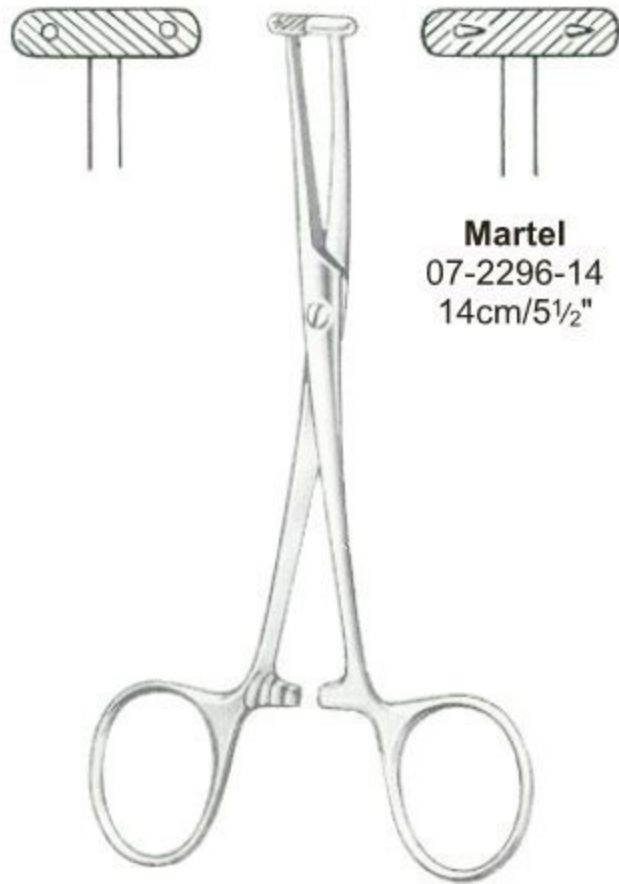

Martel
 07-2296-14
 14cm/5½"



Werheim
 07-2297-25
 25cm/10"



Werheim-Cullen
 07-2298-21
 21.5cm/8½"



Werheim
 07-2299-24
 24cm/9½"

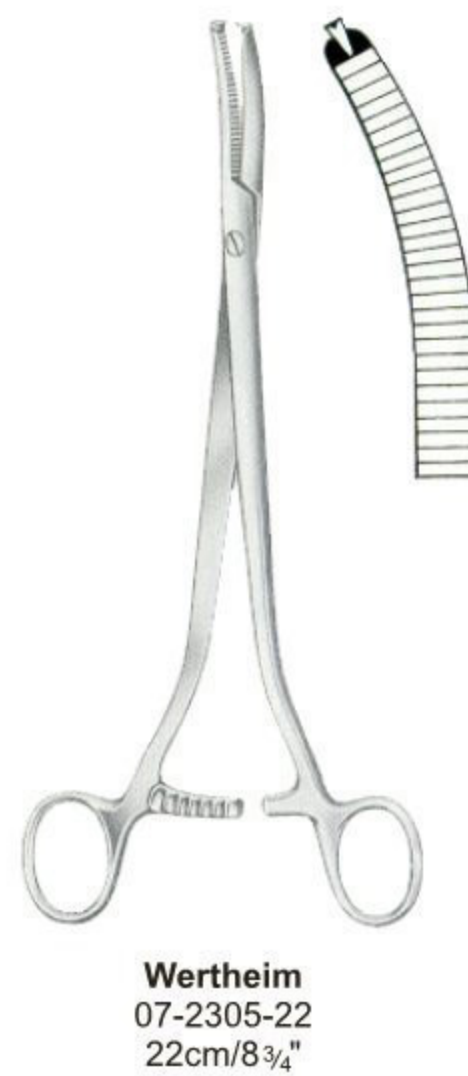
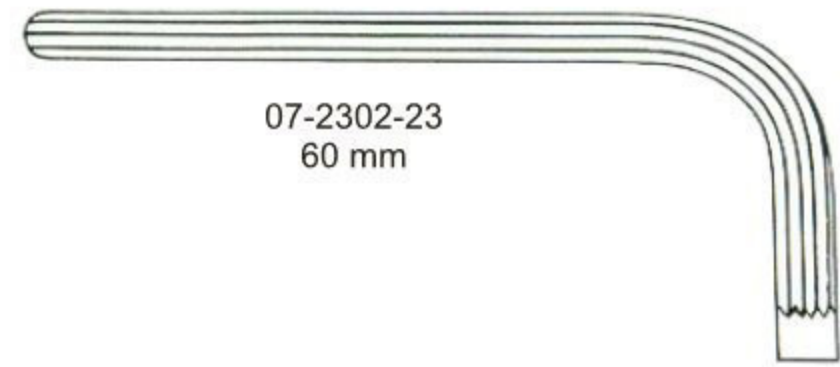
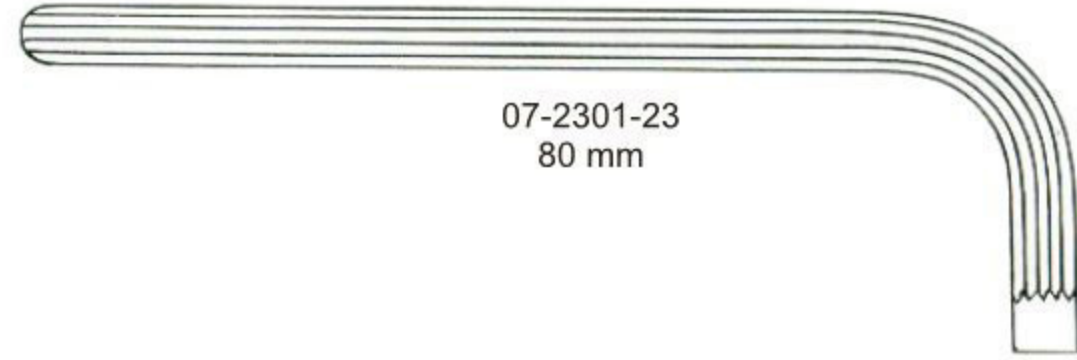
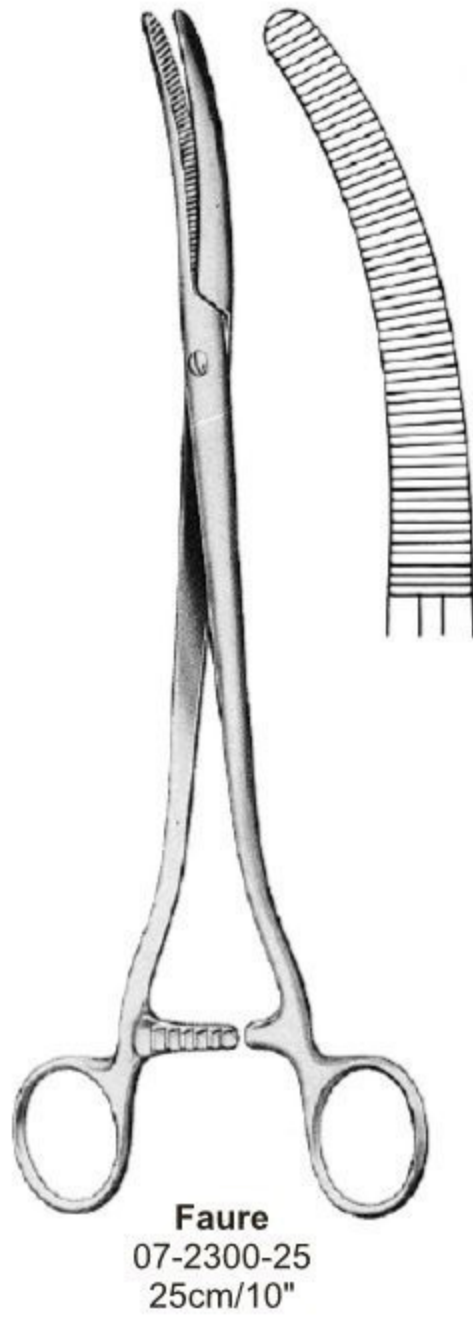



Wertheim
 07-2306-18
 18 cm/7"



Baby-Mikulicz
 07-2307-14
 14 cm/5½"

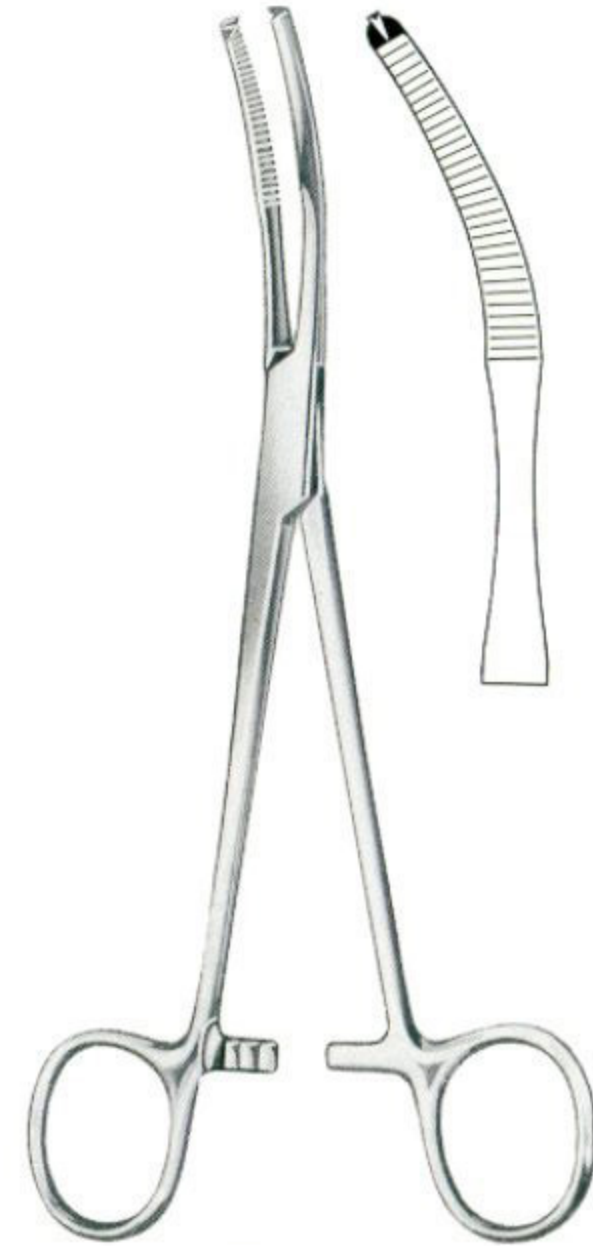

Mikulicz
 07-2308-18 18cm/7"
 07-2308-20 20cm/8"



Mikulicz
 07-2309-20
 20 cm/8"



Mikulicz
 07-2310-18
 18.5 cm/7 "

Artery Forceps ● EN
 Arterienklemmen ● DE
 Pinzas hemostaticas ● ES



Mikulicz
 07-2311-18
 18 cm/7"



Mikulicz
 07-2312-20 20 cm/8" 07-2313-20



Segond-Landau
 07-2314-24
 24 cm/9½"



Segond
 07-2315-24
 24 cm/9½"



Faure
 07-2316-20 20 cm/8" 07-2317-20



Schindler
 07-2318-20
 20 cm/8"



Schadel
 07-2319-09 9 cm/3½"



Jones
 07-2320-05 5 cm/2"
 07-2320-09 9 cm/3 ½"



Engl-Modell
 07-2321-09 9 cm/3½"



Backhaus
 07-2322-09 9 cm/3 ½"
 07-2322-11 11 cm/4 ½"
 07-2322-13 13 cm/5"
 07-2322-15 15 cm/6"

With clip for Tubing or Cable



07-2323-11 11 cm/4 ½"
 07-2323-13 13 cm/5"



Peers-Bertram
 07-2324-14 14.5 cm/5¾"



Tohoku
 07-2325-10 10 cm/4"
 07-2325-13 13 cm/5"

Artery Forceps ● EN
 Arterienklemmen ● DE
 Pinzas hemostaticas ● ES



Roder
 07-2326-13 13 cm/5"
 07-2326-15 15 cm/6"



Lorna
 07-2327-10 10 cm/4"
 07-2327-13 13 cm/5"



Bernhard
 07-2328-16 16.5 cm/6 1/2"



Lane
 07-2329-20
 20 cm/8"



Doyen
 07-2330-18
 18 cm/7"

Artery Forceps ● EN
 Arterienklemmen ● DE
 Pinzas hemostaticas ● ES



07-2331-14 14 cm/5 1/2"
 07-2331-15 15 cm/6"
 07-2331-18 18 cm/7"
 07-2331-20 20 cm/8"



07-2332-14
 14.5 cm/5 3/4"



07-2333-16 16.5 cm/6 1/2"
 07-2333-18 18.0 cm/7"



07-2334-15 15 cm/6"
 07-2334-18 18 cm/7"
 07-2334-20 20 cm/8"



Mohr
 07-2335-50 50 mm
 07-2335-60 60 mm
 07-2335-70 70 mm
 07-2335-80 80 mm

Sizes
 mm
 13
 17
 20
 25
 30

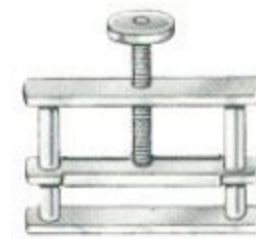

Hoffmann
 07-2336-13
 07-2336-17
 07-2336-20
 07-2336-25
 07-2336-30



Hoffmann
 07-2337-13
 07-2337-17
 07-2337-20
 07-2337-25
 07-2337-30